



Viz Engine

Product Version 3.9.0

October 11, 2017



Viz Engine





Copyright © 2017 Vizrt. All rights reserved.

No part of this software, documentation or publication may be reproduced, transcribed, stored in a retrieval system, translated into any language, computer language, or transmitted in any form or by any means, electronically, mechanically, magnetically, optically, chemically, photocopied, manually, or otherwise, without prior written permission from Vizrt.

Vizrt specifically retains title to all Vizrt software. This software is supplied under a license agreement and may only be installed, used or copied in accordance to that agreement.

Disclaimer

Vizrt provides this publication “as is” without warranty of any kind, either expressed or implied.

This publication may contain technical inaccuracies or typographical errors. While every precaution has been taken in the preparation of this document to ensure that it contains accurate and up-to-date information, the publisher and author assume no responsibility for errors or omissions. Nor is any liability assumed for damages resulting from the use of the information contained in this document.

Vizrt’s policy is one of continual development, so the content of this document is periodically subject to be modified without notice. These changes will be incorporated in new editions of the publication. Vizrt may make improvements and/or changes in the product (s) and/or the program(s) described in this publication at any time.

Vizrt may have patents or pending patent applications covering subject matters in this document. The furnishing of this document does not give you any license to these patents.

Technical Support

For technical support and the latest news of upgrades, documentation, and related products, visit the Vizrt web site at www.vizrt.com.

Last Updated

October 11, 2017

Contents

1	New in Viz Engine 3.9	16
1.1	Virtual Set with 2 frames delay	16
1.2	UHD Support for Virtual Sets	16
1.3	Support for Scenarist Closed Caption (SCC) files	16
1.4	Matrox DSX.Core in virtualized environments	16
1.5	Additional uncommon frame rates for inputs and outputs	16
1.6	NewTek TriCaster as full video board	17
1.7	EAS Support for Audio Clips	17
1.8	Improved Low Latency	17
2	Introduction	18
2.1	Related Documents	18
2.2	Customer Feedback and Suggestions	18
2.3	Customer Support Request	19
2.3.1	Submitting a Support Request	19
2.3.2	Content of a Support Request	20
2.3.3	To Submit a Support Request	20
2.3.4	Attach Log Files to a Customer Request	22
3	Software Configuration	23
3.1	Prerequisites	23
3.1.1	Environmental settings	24
3.1.2	Hardware and BIOS settings	24
3.1.3	Power management settings	24
3.1.4	User rights	25
3.1.5	Running Viz Engine and Viz Artist without administrator rights	25
3.1.6	Anti-Virus software	25
3.2	Viz Artist/Engine Folders	26
3.2.1	Installation Folders	26
3.2.2	Data Folders	26
3.3	Supported Software	27
3.3.1	Viz Engine Software	27
3.3.2	Preview Server	28
3.3.3	Viz Artist Software	28
3.4	Ports and Connections	29
3.4.1	Port Numbers	29
3.4.2	Multiplexing Ports	34
3.5	User Account Control (UAC)	35

3.6	Viz Artist and Engine Installation	36
3.6.1	Installing Viz Artist and Engine	36
3.6.2	Upgrading from a previous installation	37
3.6.3	To change or reinstall an existing installation	38
3.6.4	Silent installation of Viz Artist and Engine	38
3.6.5	To identify installed architecture and version	39
3.7	Viz Artist/Engine Platforms	40
3.7.1	VGA	40
3.7.2	Video	40
3.7.3	Trio Box CG	41
3.7.4	Dual Channel	41
3.7.5	Dual Channel VGA	41
3.8	Install the Viz License	41
3.8.1	To Apply a Viz License in the GUI	41
3.8.2	To Apply a Viz License in Viz Configuration	42
3.8.3	To Apply a Viz License with the Viz Console	43
3.9	EVS Video Server Control	43
3.9.1	Setup Requirements	43
3.9.2	RS422 and XtenDD35 Configuration	44
3.9.3	RS422 pin-out for the connector cable	44
3.9.4	RS422 Controller Set Up Examples	44
3.9.5	Bluestorm LP PCI card configuration	44
3.9.6	ExSys EX-1303 USB to RS422 connector configuration	45
3.10	Dual Channel Mode	45
3.10.1	To Configure Dual Channel	45
3.11	Trio Box CG Mode	46
3.11.1	To Configure Trio Box CG	46
3.12	Integration with Viz One	47
3.12.1	Configure Viz Engine	47
3.12.2	Install Transfer and Monitor Services on Viz Engine	47
3.12.3	Configure Local Preview of Video Files	49
3.13	Viz Engine REST interface	52
3.14	Dolby E Support	53
3.14.1	Dolby E Features	53
3.14.2	Dolby E Configuration	54
4	Starting Viz Engine	56
4.1	To Start Viz Engine	56
4.2	To Add a Viz Engine Startup Option	56
4.2.1	Viz Configuration	57
4.3	Viz Console	57
4.3.1	Issuing External Commands to Viz Engine via Console	57

4.3.2	Internal Commands	60
4.4	Viz Command Line Options	60
4.4.1	Systems with Two or More GPUs	61
5	Configuring Viz	63
5.1	Working with Viz Configuration	63
5.1.1	To Start Viz Configuration	64
5.2	Modify Viz Configuration	64
5.2.1	To Save the Current Configuration	64
5.2.2	To Reset the Viz Config File	64
5.2.3	To Restart Viz Configuration	64
5.3	Installed Configuration Profiles	65
5.3.1	To Load a Pre-Installed Configuration Profile	65
5.3.2	To Save a Custom Profile	65
5.3.3	To Load a Custom Configuration Profile	65
5.4	Audio Settings	65
5.4.1	Various Tab	66
5.4.2	Channels Tab	67
5.4.3	Manual Audio Configuration	70
5.5	Authentication	71
5.5.1	Authentication Properties	71
5.5.2	Host Info Properties	72
5.5.3	Authentication Panel Procedures	73
5.6	Camera	76
5.6.1	Camera Properties	76
5.7	Communication	77
5.7.1	Global Properties	78
5.7.2	Shared Memory Properties	80
5.7.3	VDCP Properties	81
5.8	Clock Formats	82
5.9	Database	82
5.9.1	Global Properties	83
5.9.2	Failover Properties	85
5.9.3	Deploy Properties	85
5.10	Font/Text Options	86
5.11	Global Input	88
5.11.1	To Synchronize Multiple Viz Engines	88
5.12	Import 3D Options	89
5.13	Image File Name Convert	89
5.14	Local Settings	90
5.14.1	Select Multiple Directories	91
5.15	Maps	92

5.15.1	To Add the VizWorld.ini File	93
5.16	Matrox	93
5.16.1	General Properties	94
5.16.2	VideoOut Properties	95
5.16.3	VideoIn Properties	97
5.17	Memory Management	102
5.18	Multiview	103
5.19	Path Aliases	104
5.19.1	To Add a Path	104
5.20	Output Format	105
5.20.1	UHDTV and 4K Support	107
5.21	Plugins	107
5.22	Render Options	109
5.23	Scene Default Values	112
5.23.1	Media Asset Configuration	114
5.24	Spaceball	114
5.25	User Interface	116
5.25.1	Various	117
5.25.2	Colors	121
5.25.3	Shortcuts	124
5.26	Video Board	124
5.26.1	Video Board Properties	124
5.27	Video Input	126
5.27.1	Live and Clip Channels	127
5.27.2	Stream Channels	127
5.27.3	No Onboard Video Board	128
5.28	Video Input: Clip Input	128
5.28.1	Clip Input Properties	129
5.29	Video Input: Stream Input	130
5.29.1	Stream Input Properties	131
5.30	Video Output	135
5.30.1	Video Output Properties (1)	135
5.30.2	Video Output Editor	136
5.31	Video Output: Clip Output	137
5.31.1	Placeholders for Variables	138
5.32	Video Output: SHM Output	138
5.33	Viz Artist 2.x	138
5.33.1	Viz Artist 2.x	139
5.34	Viz License Information	139
5.35	Viz One	140
5.35.1	Viz One Properties	140

5.36	Viz Artist/Engine Log Files	142
5.36.1	Viz Render Log	142
5.36.2	Viz Trace Log	142
5.36.3	Viz Gui Log	143
5.36.4	Viz Shaders Log	143
5.36.5	Viz Console Log	143
5.36.6	Viz Gui Connection Log	143
5.36.7	Create Log Files with Log and Clog Commands	144
6	On Air Mode	145
6.1	Director Control Panel	145
6.2	Control Buttons	146
6.3	Performance	147
6.3.1	Performance Analyzer	147
6.3.2	Performance Bar	148
6.4	On Air Information Panel	149
6.4.1	Basic Tab	149
6.4.2	Clients Tab	150
6.5	License Information	150
7	Audio in Viz	152
7.1	Overview	152
7.1.1	Channels	152
7.1.2	Matrox Routing	153
7.1.3	DirectShow	153
7.2	Device Recognition and Selection	154
7.3	Timing Behavior and Delay Settings	155
7.3.1	Latency adjustment on the DirectSound audio device	155
7.4	Channel Setup and Clip Channel Routing	158
7.4.1	To Test Audio Channel Setup	158
7.5	Audio Plug-in	158
7.6	Clip Formats	159
7.7	Speaker Names	159
7.8	Matrox Audio	160
7.8.1	To Enable Matrox Audio	160
7.9	Emergency Alert System	160
7.9.1	To specify output channels for EAS	161
8	Shared Memory (SHM)	162
8.1	External Data Input	162
8.1.1	SHM over TCP	163
8.1.2	SHM over UDP	164
8.1.3	Plugin API	165

8.2	Internal Data (Interactive Scene)	166
8.3	Synchronization	167
8.3.1	TCP and UDP Synchronization	167
8.3.2	External Control Synchronization	168
8.3.3	Command Synchronization	169
8.4	Snapshot	169
9	Frame Accurate Output	171
9.1	Prerequisites	171
9.2	To Configure Frame Accurate Output	171
9.3	Commands	172
9.4	General Purpose I/O Commands	172
9.4.1	Input Functionality	173
9.4.2	Flow of the GPI signal	174
9.4.3	Output Functionality	175
9.4.4	Commands	175
9.5	Timed Command Execution	177
9.5.1	Time code related commands	177
9.5.2	Prerequisites	178
9.5.3	Configuration	178
9.5.4	Settings for X.mio2 and X.mio2+ boards.	179
10	Video Wall Configuration	181
10.1	Hardware Requirements and Recommendations	181
10.1.1	Minimum Hardware Configuration for Video Walls	181
10.1.2	Recommended Configuration for Video Walls	182
10.1.3	Recommended Configuration for Video Walls Using Multiple Graphics Cards	182
10.2	Performance Considerations	182
10.2.1	Hardware Considerations	182
10.2.2	Scene Design Considerations	183
10.3	Video Wall Setup Instructions	183
10.3.1	Pre-Requirements for all Setups	184
10.3.2	Configure the NVIDIA driver for Video Wall	185
10.3.3	Order of Steps to Set Up NVIDIA Mosaic	186
10.3.4	NVIDIA Quadro Sync	186
10.3.5	Custom Resolution for 59.94 Hz Refresh Rate	187
10.3.6	NVIDIA Mosaic Configuration for 1080i50	192
10.3.7	NVIDIA Mosaic Configuration for 1080i60M	198
10.3.8	Viz Engine Video Wall Configuration Settings	201
10.4	Troubleshooting Video Wall Configurations	204
10.4.1	Performance issues	205

10.4.2	Steps to recover from severe NVIDIA Mosaic driver related issues	205
10.4.3	Experiencing BSOD or system freeze while setting up Mosaic	205
10.4.4	Only some displays of the Video Wall display an image	205
10.4.5	Missing NVIDIA Control Panel settings	206
10.4.6	NVIDIA Control Panel crashes	206
10.4.7	Mosaic configuration not supported error	206
10.4.8	G-Sync status LEDs or Topology reports indicate a synchronization issue	206
10.4.9	Poor performance when using GFX channels as DVE	207
10.4.10	Jittering on HP Z840	208
10.4.11	Other synchronization issues	208
11	NVIDIA Graphics Cards	209
11.1	Working with Two Graphics Cards	209
11.2	Working with Synchronous Output	210
11.2.1	Hardware Requirements	210
11.2.2	Software Requirements	210
11.2.3	Synchronous Output Configuration	210
11.2.4	Video Wall Distributor	211
11.2.5	To Configure a Machine with Two Graphics Cards	211
11.3	NVIDIA Driver Configuration	212
11.3.1	To Configure NVIDIA Driver Settings for Viz Engine, Video mode	212
11.3.2	To Configure NVIDIA Driver Settings for Viz Engine, VGA mode	214
11.3.3	Vertical Sync	214
11.3.4	To Configure the V-phase Settings when Synchronizing the Card	214
11.3.5	To Configure Mosaic	214
11.3.6	NVIDIA G-SYNC Card	215
11.4	NVIDIA Driver History	218
11.4.1	NVIDIA Maxwell and Kepler Architecture Cards - Quadro Series	218
12	Matrox Hardware	220
12.1	Matrox X.mio3 IP	220
12.1.1	Key features	221
12.1.2	X.mio3 IP Command Examples	223
12.2	Matrox X.mio3	224
12.2.1	Matrox X.mio3 Overview	224
12.2.2	X.mio3 FH	225
12.2.3	X.mio3 I/O Port Configuration	228
12.2.4	Viz Engine Matrox Video Mapping Configuration	228
12.2.5	To Upgrade X.mio3 Class and Firmware	230
12.2.6	X.mio3 AES Audio Kit	230
12.3	Matrox X.mio, X.mio2 and X.mio2 Plus	231
12.3.1	X.mio2 and X.mio2 Plus Cables and Connectors	232

12.3.2	X.mio2 Standard Cable Configuration	233
12.3.3	Breakout Cables and Connectors	234
12.3.4	Video Cable Assignment	237
12.3.5	Audio-extension Card	237
12.3.6	X.mio2 License Upgrade	239
12.4	DVE Performance with X.mio3, X.mio2 Plus and X.mio2 Systems	240
12.4.1	PAL/NTSC	240
12.4.2	720p50	240
12.4.3	720p60M	241
12.4.4	1080i50	241
12.4.5	1080i60M	241
12.5	Audio Cable Assignment	242
12.5.1	AES Input Cable Assignment	242
12.5.2	AES Output Cable Assignment	244
12.5.3	Embedded Input	245
12.5.4	Embedded Output	245
12.6	Matrox DSX LE Series	245
12.6.1	Cables and Connectors	246
12.6.2	Breakout Cables and Connectors	247
12.6.3	Video Cable Assignment	247
12.6.4	Audio Cable Assignment	247
12.7	Matrox X.RIO	248
12.7.1	Cables and Connectors	249
12.7.2	Install and Configure the Matrox X.RIO	249
12.8	Matrox X.Open	252
12.9	Matrox Driver Installation	252
12.9.1	To Install the Matrox Driver	252
12.9.2	To Remove the Matrox Driver	254
12.9.3	To Upgrade the Matrox Driver	254
12.9.4	To Check the Installation	254
12.9.5	To Check the Installation with Windows Device Manager	257
12.10	Mixed Mode Video Support	257
12.10.1	Source: PAL or NTSC	258
12.10.2	Source: 720p	258
12.10.3	Source: 1080i	259
12.11	Supported Codecs	260
12.12	Watchdog	261
12.12.1	Mechanical Bypass	261
12.12.2	Hardware Bypass	261
12.12.3	Transition from Watchdog to Video	261
12.12.4	To Enable Mechanical Bypass	261

12.13	Configuration History for Matrox X.mio and DSX Series	262
12.13.1	Configuration History for Matrox X.Open	262
12.14	Troubleshooting Matrox Video Hardware	263
12.14.1	Replacing a Video Board	263
12.15	General Information	264
12.15.1	Single Channel performance (1080i50):	264
12.15.2	Dual Channel performance (1080i50):	264
13	BlueFish444	266
13.1	Epoch 4K Supernova, Epoch 4K Supernova S+ and Epoch Supernova CG	267
13.1.1	Epoch 4K Supernova	267
13.1.2	Epoch 4K Supernova S+	268
13.1.3	Epoch Supernova CG	270
13.2	Epoch Neutron	271
13.2.1	Epoch Neutron Connectors	271
13.3	Configuration History for BlueFish444	272
13.3.1	The following driver and firmware versions are supported:	272
13.4	Special Configuration Options for Bluefish444	273
13.4.1	To Enable Dual Link Input for Epoch 4K Supernova and Epoch 4K Supernova S+ Boards	273
13.4.2	To Enable Dual Link Output for Epoch Neutron	273
13.4.3	To Enable Automatic Bypass for BlueFish444 Epoch Boards	273
14	Digital Video Systems	275
14.1	DVS Atomix HDMI	275
14.1.1	Connectors	276
14.1.2	Supported Codecs	280
14.1.3	Configuration History	281
14.1.4	Licensing	281
14.2	DVS Atomix LT	281
14.2.1	Connectors	282
14.2.2	Supported Codecs	286
14.2.3	Configuration History for DVS	286
14.2.4	Licensing	286
15	NVIDIA Quadro SDI Capture	287
15.1	Connectors	287
15.2	Drivers for NVIDIA Quadro SDI capture card	287
16	AJA Io 4K	289
16.1	Overview and Connectors	289
16.2	Configuration	290
16.3	Audio configuration	290

16.4	Video Configuration	290
16.5	Configuration Utilities	290
16.6	Firmware Upgrade	291
16.7	AJA Io 4K Features and Specifications	292
16.7.1	Features:	292
16.7.2	Technical Specifications	292
16.8	Configuration History	292
17	Video, Audio, Server and Graphics Card Installation	293
17.1	HP Z440	293
17.1.1	HP Z440 PCI/PCIe Slot layout and usage	294
17.1.2	Z440 BIOS Settings	295
17.1.3	Memory expansion	295
17.2	HP Z840	295
17.2.1	HP Z840 PCI/PCIe Slot layout and usage	296
17.2.2	Z840 BIOS Settings	297
17.2.3	Memory expansion	297
17.3	HP DL360 Gen9	297
17.3.1	HP DL360 Gen9 BIOS settings	298
17.4	HP DL380 Gen9	298
17.4.1	HP DL380 Gen9 PCI/PCIe Slot layout and usage	299
17.4.2	HP DL380 Gen 9 BIOS settings	299
17.5	Dell R7910 (2U) Rack Server	300
17.5.1	Dell R7910 Rack Workstation slots	300
17.5.2	To setup a single channel graphics with Video and AES Audio	300
17.5.3	To setup Dual Channel with two K4200 graphics cards	301
17.5.4	BIOS settings	301
17.6	Supermicro SuperServer 7048 GR-TR	301
17.6.1	GPU Installation	301
17.6.2	BIOS Settings	303
17.7	HP ZBook 15/17 G3 Mobile workstation	303
17.7.1	HP ZBook BIOS settings	304
17.8	Deprecated servers	304
17.8.1	HP ML350p Gen8	305
17.8.2	HP Z420	307
17.8.3	HP Z800	309
17.8.4	HP Z820	313
17.8.5	HP DL370	315
17.8.6	HP xw8200	318
17.8.7	HP xw8400	319
17.8.8	HP xw8600	320
17.9	Handling and installing cards	322

18 Legacy Cards	324
18.1 NVIDIA Legacy Cards	324
18.1.1 NVIDIA Quadro 6000	325
18.1.2 NVIDIA Quadro 5000	325
18.1.3 NVIDIA Quadro 4000	325
18.1.4 NVIDIA Quadro 2000	326
18.1.5 NVIDIA Quadro FX 1400	326
18.1.6 NVIDIA Quadro FX 1500	326
18.1.7 NVIDIA Quadro FX 1700	326
18.1.8 NVIDIA Quadro FX 1800	327
18.1.9 NVIDIA Quadro FX 3400	327
18.1.10 NVIDIA Quadro FX 3450	327
18.1.11 NVIDIA Quadro FX 3500	327
18.1.12 NVIDIA Quadro FX 3700	327
18.1.13 NVIDIA Quadro FX 3800	328
18.1.14 NVIDIA Quadro FX 4400	328
18.1.15 NVIDIA Quadro FX 4500	328
18.1.16 NVIDIA Quadro FX 4600	328
18.1.17 NVIDIA Quadro FX 4800	329
18.1.18 NVIDIA Quadro FX 5500	329
18.1.19 NVIDIA Quadro FX 5600	329
18.1.20 NVIDIA Quadro FX 5800	330
18.1.21 NVIDIA Quadro K600	330
18.2 BlueFish444 SD Lite Pro Express	330
18.2.1 Connectors	331
18.2.2 Driver Installation	331
18.3 BlueFish444 Iridium SD	332
18.3.1 Connectors	332
18.3.2 Driver Installation	333
18.4 BlueFish444 Epoch 2K Horizon	333
18.4.1 Configuration History	334
18.5 Digital Voodoo D1 Desktop	334
18.5.1 Configuration History	334
18.6 Digital Voodoo DeepBlue LT	335
18.6.1 Configuration History	335
18.7 Digital Voodoo Red Devil V3	335
18.7.1 Configuration History	336
18.8 DVS Centaurus II	336
18.8.1 Connectors	337
18.8.2 Supported Codecs	340
18.8.3 Driver Installation	340

18.8.4	Licensing	341
18.9	Pinnacle Targa 3200	344
18.9.1	Configuration History	344
18.10	LPT Controller for a Viz License Dongle	344
18.10.1	To Install an LPT Controller Card	344

This Administrator Guide gives details on the configuration and installation of Viz Engine. It will also explain settings available through its configuration user interface.

The term Viz is used for the programs installed and run on the computer. This is used as a general reference for all modes of the program:

- Viz Artist (see the [Viz Artist User Guide](#))
- Viz Engine
- Viz Configuration

What mode the program can run is determined from the hardware dongle attached to the machine. The different modes and the hardware dongle are detailed in this User Guide.

1 New in Viz Engine 3.9

- [Virtual Set with 2 frames delay](#)
- [UHD Support for Virtual Sets](#)
- [Support for Scenarist Closed Caption \(SCC\) files](#)
- [Matrox DSX.Core in virtualized environments](#)
- [Additional uncommon frame rates for inputs and outputs](#)
- [NewTek TriCaster as full video board](#)
- [EAS Support for Audio Clips](#)
- [Improved Low Latency](#)

1.1 Virtual Set with 2 frames delay

The overall in-to-out delay in virtual sets is reduced to 2 frames in interlaced formats or 4 frames in progressive formats, including UHD, when using Matrox X.mio3 or DSX LE 4 and configured Fast Texture Mode. However, for UHD a high-performance GPU is necessary to render complex virtual sets in time.

1.2 UHD Support for Virtual Sets

With the introduction of the low-latency infrastructure, it is also possible to run virtual sets in UHD, making use of all features that are supported in HD studios as well. As mentioned above, a powerful GPU is needed to render complex studios.

1.3 Support for Scenarist Closed Caption (SCC) files

To respect typical workflows to bring Closed Caption into the SDI output, VizEngine is now supporting the direct use of externally created SCC files as source for CC, coming either from internal sources or external partners, creating the transcription for video material. The created text files contain time codes for the CC start and the encoded caption itself. Files are read in sync with the corresponding clip and the CC data will then be put into VBI/VANC surfaces and played out together with the rest of the data.

1.4 Matrox DSX.Core in virtualized environments

DSX.Core enables us to acquire licenses for the Matrox core across the network using DSX.core dongles. Whether those licenses are requested by engines running on physical or virtual machines doesn't matter. The general implementation/integration allows the use of Matrox software modules for media processing in virtualized broadcast infrastructures based, on the Matrox DSX.Core SDK without the use of a physical interface (USB dongle).

1.5 Additional uncommon frame rates for inputs and outputs

Several devices, like 360° cameras, that are used in broadcast environments, don't support the standardized resolution/frame rate combinations. As the Matrox cards are able to work with those settings, we added the following rates to the list of available output formats:

- 1080p 23.976

- 1080p 25
- 1080p 29.97
- 2160p 25
- 2160p 29.97
- 2160p 30

1.6 NewTek TriCaster as full video board

The integration between Viz Engine and NewTek's TriCaster now supports up to four inputs and outputs based on the NDI protocol. To enable the NewTek TriCaster integration, first set **Check Video Card to User Defined** in the **Video Board** section of Viz Configuration. Then select NewTek TriCaster as the **Software I/O Mode**.

1.7 EAS Support for Audio Clips

This enables the user to not only use the Text-to-Speech plugin to send Emergency Alert System (EAS) messages, but also use audio clips, which are recorded prior to sending. Those clips can be added dynamically. Viz Engine will then add them directly into predefined audio channels and also mute the other channels.

1.8 Improved Low Latency

Improved low latency improves the existing Fast Texture Mode for the [Matrox X.mio3](#) and [Matrox DSX LE 4](#) cards. It reduces the overall in-to-out delay to 2 frames in interlaced formats, and 4 frames in progressive formats. All other settings stay the same, with no additional tweaks necessary. Depending on the installed hardware and the scene requirements, it might be necessary to increase the delay to 5 frames when running UHD (2160p) resolutions.

2 Introduction

This Administrator Guide gives details on the configuration and installation of Viz Engine. It will also explain settings available through its configuration user interface.

The term Viz is used for the programs installed and run on the computer. This is used as a general reference for all modes of the program:

- Viz Artist (see the [Viz Artist User Guide](#))
- Viz Engine
- Viz Configuration

What mode of program that can run is determined from the hardware dongle that is attached to the actual machine (the different modes and the hardware dongle are detailed in this User Guide).

This Section contains information on the following topics:

- Document Structure
- [Related Documents](#)
- [Customer Feedback and Suggestions](#)
- [Customer Support Request](#)

2.1 Related Documents

- **Viz Artist User's Guide:** Contains information on how to install Viz Engine and create graphics scenes in Viz Artist.
- **Viz Artist Script reference:** Contains information on how to create scripts for a scene.
- **Viz Engine Plug-in SDK reference:** Contains information on how to create a customized Viz plug-in.

2.2 Customer Feedback and Suggestions

We encourage suggestions and feedback about our products and documentation. To give feedback and, or suggestions, please identify your local Vizrt customer support team at www.vizrt.com.

1. Go to www.vizrt.com.
2. Click on **Contact** (1).

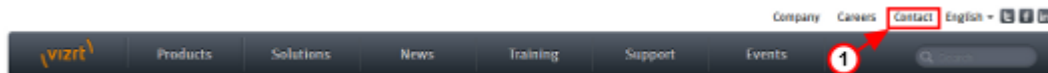

3. The Vizrt office which is nearest to your location will be shown (2), or select from the list of Vizrt offices.

4. Click on 'Contact'.

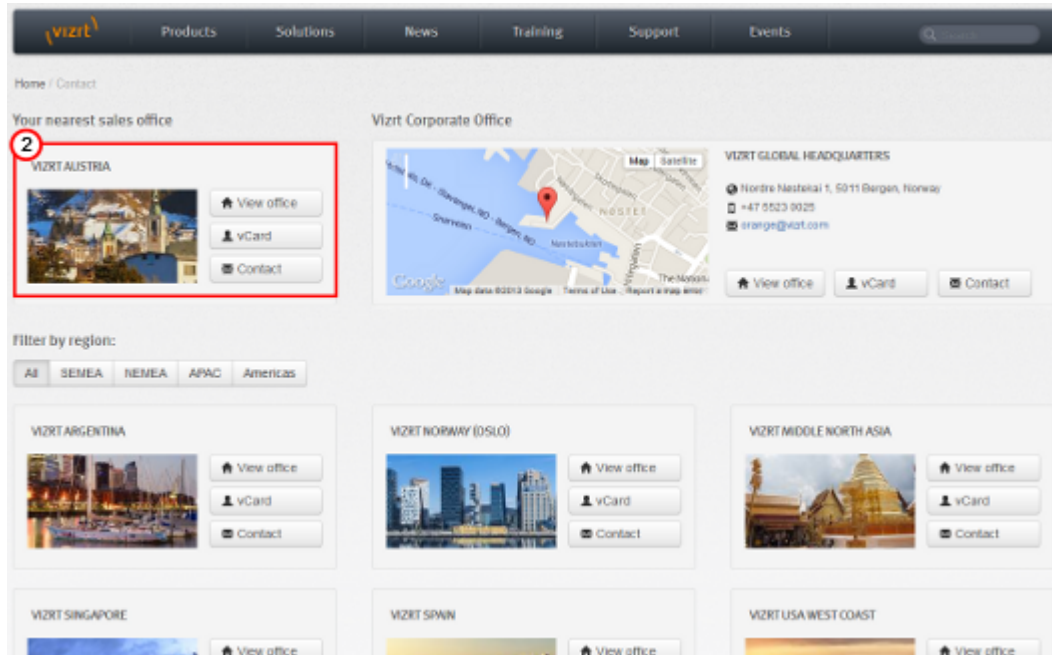

5. Complete the required details in the window that opens.

.....
Note: If this message is for Customer Support, and there is a Support Contract in place, then click on the 'For support requests, please visit our support portal' link in the message window.
.....

6. Click on **CONTACT ME**.

A Vizrt representative will contact you as soon as possible.

2.3 Customer Support Request

Support Requests are supported by Vizrt if Customers have a valid Service Agreement in operation. Customers who do not have a Service Agreement and would like to set up a Service Agreement should contact their regional sales representative (see [Customer Feedback and Suggestions](#)).

When submitting a Support Request relevant and correct information should be given to Vizrt Support, to make sure that Vizrt Support can give the quickest and best solution to your Support Request.

This section contains information on the following topics:

- [Submitting a Support Request](#)
- [Content of a Support Request](#)
- [To Submit a Support Request](#)
- [Attach Log Files to a Customer Request](#)

2.3.1 Submitting a Support Request

Before a Support Request is submitted make sure that you:

Read:

- The relevant User Guide or Guides
- The release notes

and Check:

- That the system is configured correctly
- That you have the specified hardware, tested and recommended versions
Always refer to your Vizrt Service Level Agreement document.

When completing a Support Request, add as much information as possible.

2.3.2 Content of a Support Request

The report should contain information about these topics:

- **Problem Description:** Include a good description of what the problem is and how to reproduce it. Remember to use simple English.
- **Screen Shots and Illustrations:** Use to simplify the message.
- **System Log Files:** Send the system log files (see [Attach Log Files to a Customer Request](#)).
- **Dump Files:** Send any dump files generated from a crash (<viz data folder>).
- **System Viz Config File:** Send the system Config file (<viz data folder>).
- **Software Configuration:** Add exact versions of software (-build) used.
- **Hardware Configuration:** Add exact versions of hardware used.
- **System Setup:** Describe differences in the installation, if any, from the recommended setup.
- **System Network:** Add a description of how the network, bandwidth, routers, and switches are configured.

Always refer to your Vizrt Service Level Agreement document.

2.3.3 To Submit a Support Request

1. Go to www.vizrt.com.
2. Click on Support (1).
3. Click on Report a case (2).

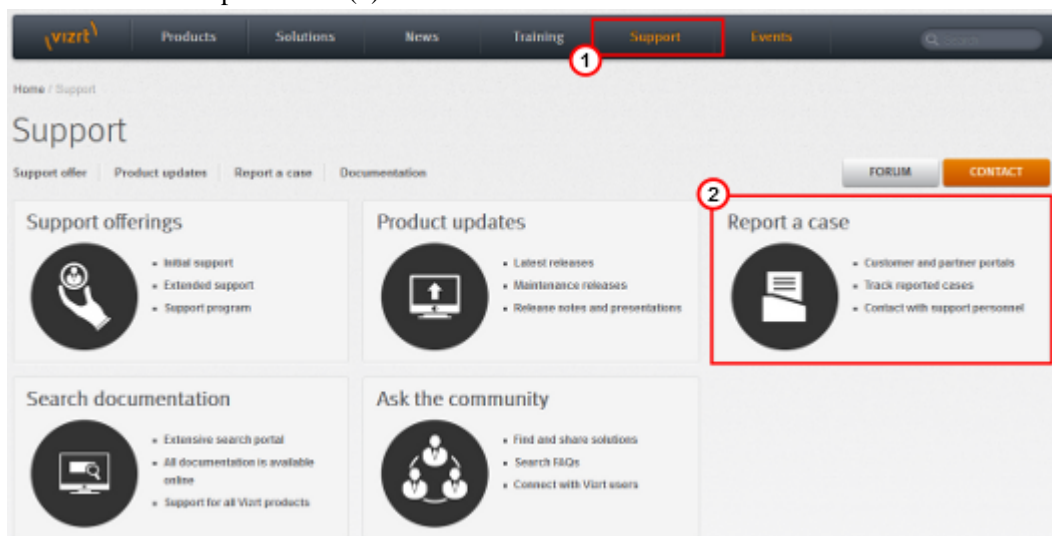

4. Click on **LOG IN** (3).
5. Log-in to the Customer and Partner portal.

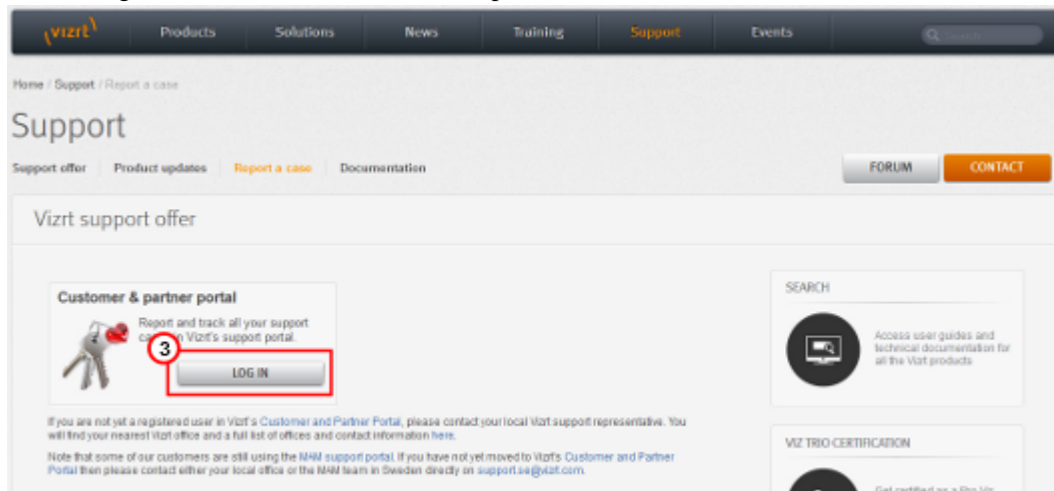

6. Click on **Report a Case** (4).

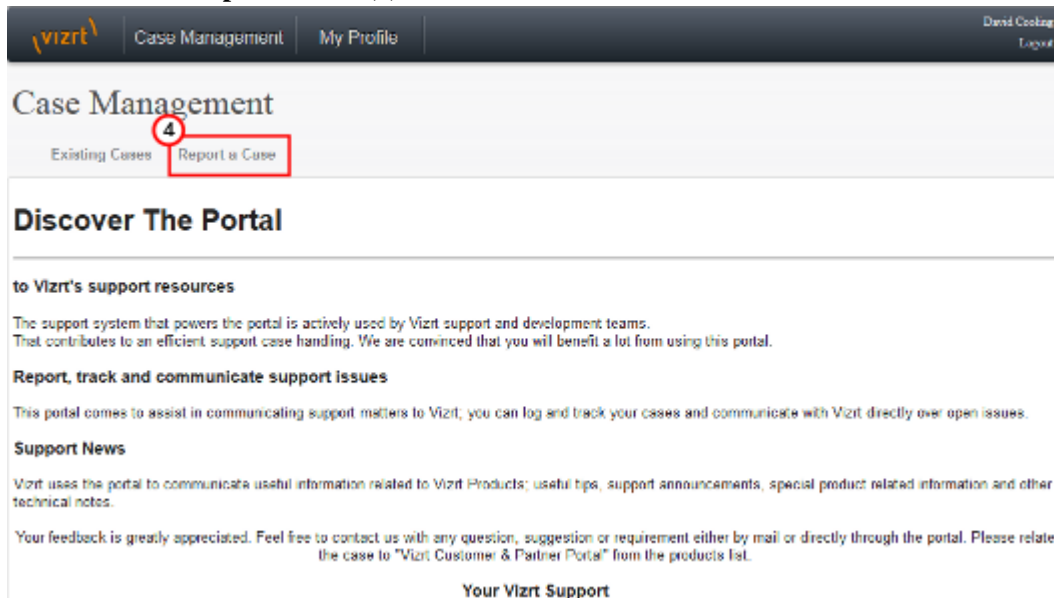

7. In the online form complete the required minimum information (shown by a red asterisk):
 - **Contact:** Your name
 - **Account:** Your account
 - **Product:** The product the support request refers to.
 - **Case Type:** The type of support request required
8. Click **SAVE**.
9. In the saved Support Case that opens, complete the various text boxes and upload any required documents, files, etc (see [Content of a Support Request](#)).

.....
Note: The entered text or uploaded documents / files are automatically added.

To track the status of open support tickets, log in to the Customer and Partner portal. Add information or communicate about the cases directly with the support team.

2.3.4 Attach Log Files to a Customer Request

Log files can provide important information when dealing with an error situation or when diagnosing performance issues. Viz Artist/Engine can write various log files that can be valuable when solving issues. For more information about the log files available see the [Viz Artist/Engine Log Files](#) section.

Consult your customer representative when deciding which logs files to attach. As a general rule: the more log files, the better. Always try to include log files for:

- The actual software/hardware configuration in use, as detailed as possible.
- The relevant Viz Artist/Engine log files.
- The Viz Engine configuration file, or if using a dual-engine setup: the Viz Engine configuration files.

.....
Note: The Viz Engine configuration file is a plain text file located in %ProgramData%\Vizrt\viz3. The filename includes the host name, and numbers indicating which Engine is used: VIZ-<hostname>-<0.0>.cfg. For example: C:\ProgramData\vizrt\viz3\VIZ-MyHost-0-0.cfg
.....

3 Software Configuration

This section details the prerequisites and supported options for the Viz Engine/ Artist installation, and procedures on how and where to install Viz Artist/Engine.

This section contains information on the following topics:

- [Prerequisites](#)
- [Viz Artist/Engine Folders](#)
- [Supported Software](#)
- [Ports and Connections](#)
- [User Account Control \(UAC\)](#)
- [Viz Artist and Engine Installation](#)
- [Viz Artist/Engine Platforms](#)
- [Install the Viz License](#)
- [EVS Video Server Control](#)
- [Dual Channel Mode](#)
- [Trio Box CG Mode](#)
- [Integration with Viz One](#)
- [Viz Engine REST interface](#)
- [Dolby E Support](#)

3.1 Prerequisites

- [Environmental settings](#)
- [Hardware and BIOS settings](#)
- [Power management settings](#)
- [User rights](#)
- [Running Viz Engine and Viz Artist without administrator rights](#)
- [Anti-Virus software](#)

Viz Artist and Engine runs on the following platforms:

Viz Artist/Engine version	Operating System
3.9.0	<ul style="list-style-type: none">• Windows 10 (64-bit and 32-bit)• Windows Server 2012 R2• Windows 7 (64-bit only)
3.8.3, 3.8.2	<ul style="list-style-type: none">• Windows Server 2012 R2• Windows 7 (64-bit only)
3.8.1, 3.8.0, 3.7.2	<ul style="list-style-type: none">• Windows Server 2008 R2/SP1 (64bit)• Windows 7 (64-bit only)

Viz Artist/Engine version	Operating System
3.7.1, 3.7.0	<ul style="list-style-type: none"> • Windows Server 2008 R2/SP1 (64bit) • Windows 7 (64-bit and 32-bit)
3.6.4	<ul style="list-style-type: none"> • Windows Server 2008 R2/SP1 (64bit) • Windows 7 (64bit).Windows XP SP3 (32bit)

For optimal performance, use the pre-installed Windows image from Vizrt. You can obtain the Windows image files from your [local support office](#).

The following prerequisites apply on all platforms. Applying the changes may require local administrator access rights, new or changing group policy entries, or modifying services. Contact your local IT manager for further instructions.

3.1.1 Environmental settings

Perform all Windows Updates, except hardware driver updates. This is especially important for drivers related to NVIDIA and Matrox hardware, and the Sentinel Hardlock dongle drivers. In addition to this;

- In Windows 7, the Aero theme must be disabled
- Turn off balloon tips
- Turn off windows sounds
- Turn off AutoPlay
- Turn off Windows Media Player Network Sharing Service
- Disable Windows Defender
- Set **Visual Effects** to **Adjust for best performance**. This is set in the Performance Options window; right click the Start button and select **System**, then select **Advanced system settings** and click the **Settings** button in the **Performance** section.

3.1.2 Hardware and BIOS settings

The following considerations must be made regarding hardware:

- There must only be one active network card
- Hardware must be installed, and BIOS configured, as suggested for the machine model in the [Video, Audio, Server and Graphics Card Installation](#) chapter.

3.1.3 Power management settings

Power management and hibernation mode must set to **Off**. Execute `powercfg -h off` from the command line to remove `hiberfil.sys` from the hard disk. In addition to this, set the following under Power Options:

- Never turn off display
- Never turn off hard disks

- Disable USB selective suspend setting
- Set Power button action to Do nothing. This prevents accidental shutdown in case someone presses the power button by mistake

3.1.4 User rights

The user must have special rights to run Viz Artist and Viz Engine. This can be achieved by assigning local administrator rights to the user, or by explicitly granting the required privileges. See [Running Viz Engine and Viz Artist without administrator rights](#) for further details.

Any hardware solution provided by Vizrt is certified for use with Viz Engine. These come with a predefined default User that has administrator rights on the machine. The default administrator account is as follows:

User name	Password	Account Type
Admin	vizrt	Computer Administrator

.....
IMPORTANT! Make sure that you change this password after initial installation!

To learn more about the different user account types, refer to the Windows operating system documentation, or visit www.microsoft.com.

3.1.5 Running Viz Engine and Viz Artist without administrator rights

There might be restrictions on user rights in some production environments. Although execution of Viz Engine and Viz Artist normally requires local administrator rights, it is possible to manually adjust the rights of the executing user by granting the following four privileges:

- SeIncreaseBasePriorityPrivilege
- SeCreateGlobalPrivilege
- SeCreatePagefilePrivilege
- SeIncreaseWorkingSetPrivilege

.....
IMPORTANT! Please contact the local IT manager for further information on how this is handled within the organization.

3.1.6 Anti-Virus software

Anti-Virus software, including end-point protection, can cause various problems such as time-out and performance issues on the Graphic Hub database and other Vizrt machines, as every file is checked. To avoid these problems, make sure to exclude the **VizDb.exe** process and the underlying Graphic Hub data directory (default D or E drive and folder "VizGHData") in the scan/real-time settings of the Anti-Virus software.

If any Anti-Virus software is used without the above settings, Vizrt cannot guarantee optimal performance, or the long term stability of Vizrt products.

There are hundreds of Anti-Virus software packages on the market. Vizrt does not recommend the use of any specific Anti-Virus software package or version, or give any recommendations on how to setup any Anti-Virus software suites in relation to Vizrt software and machines.

See Also

- [Viz Artist/Engine Folders](#)
- [Supported Software](#)

3.2 Viz Artist/Engine Folders

This section details the location of the Viz Artist/Engine default installation and data folders.

3.2.1 Installation Folders

Because the user interface (GUI) is a 32-bit application, the GUI is installed in a 32-bit folder in Viz Artist /Engine 64-bit installations. The default installation folders are:

Windows System	Viz Artist/Engine Platform	Installation Folder
Windows 32-bit	32 bit	C:\Program Files\vizrt\Viz3
	64 bit	N/A
Windows 64-bit	32 bit	C:\Program Files (x86)\vizrt\Viz3
	64 bit	C:\Program Files\vizrt\Viz3\ C:\Program Files (x86) \vizrt\Viz3Gui

In this Administrator’s Guide, any reference to the Viz Artist and Engine installation folder, for example C:\Program Files\vizrt\Viz3, is replaced with the text <viz install folder>.

.....
Note: Viz Config files that already exist from a previous installation are automatically copied on install time if the installation folder did not change. If Viz Engine/Artist is installed in a different installation folder then Viz Config files must be manually copied from the old installation folder to <viz data folder>.

3.2.2 Data Folders

Files which are created or modified by Viz Artist/Engine are located at %ProgramData%\vizrt\viz3, which usually resolves to C:\ProgramData\vizrt\viz3. This folder is referenced as <viz data folder> throughout this Administrator’s Guide, and contains, for example:

- Viz Config files
- Script plug-ins
- Crash dump files

Temporary files are located at: %TMP%\vizrt\viz3, which usually resolves to C:\Users\<user name>\AppData\Local\Temp\vizrt\Viz3. This folder is referenced as <viz temp folder> throughout this User Guide.

Script Plug-ins are located in the <viz data folder>\ScriptPlugins subfolder.

.....
Note: Script Plug-in files that already exist from a previous installation are automatically copied on install time if the installation folder did not change. If Viz Engine/Artist is installed in a different installation folder then Script Plug-in files must be manually copied from the old installation folder to <viz data folder>\ScriptPlugins
.....

3.3 Supported Software

3.3.1 Viz Engine Software

To run Viz Engine as a program or preview (optional) machine, the following software and configuration is needed:

Viz Engine specifications

Category	Requirement
Software	<ul style="list-style-type: none">• Extra Viz Artist/Engine 2 or 3 Plug-ins (only for Viz Artist/Engine 2.x)• Viz Engine 2.8 PL5 HotFix3, Viz Engine 3.5.1, or later• DataPool 2.10 or later• Viz World Client 12.0 or later• Optional: When used for local preview of video clips from Viz One, Viz Engine must be installed with an MPEG-4 codec and Matroska splitter
Hardware	License dongle
Executable(s)	viz.exe
Ports and Connections	<ul style="list-style-type: none">• 6100 (preview and playout)• 14300 (Viz Multiplexer)• 50007-50010 (multiplexing)
Network access	<ul style="list-style-type: none">• Mapped drive to VOS still store folder• Local preview: Mapped drive to Viz Engine data root

Machines configured for local preview need an OpenGL compatible graphics card and at least 512MB of memory (RAM) in addition to a reasonably new processor. Some graphics features on a preview machine will not be shown exactly as on a Viz Engine renderer. This is limitations in the OpenGL features on the graphics cards, and not related to Vizrt's software.

3.3.2 Preview Server

The Preview Server option is used in situations where Viz Engine is used to provide frames for snapshot or thumbnail generation. A typical use case would be to connect multiple Newsroom Components to a preview server.

The Preview Server must be installed on a separate Viz Engine machine with its own license.

Category	Requirement
Software	<ul style="list-style-type: none">• Preview Server 1.0 or later• Microsoft .NET Framework 4• Viz Artist/Engine 2.8, 3.2, or later
Hardware	License dongle
Executable(s)	PreviewServer.exe
Ports and Connections	54000: Used to connect over http with the REST interface.
Network access	Uses the ZeroConf protocol to announce available services.

3.3.3 Viz Artist Software

The Viz Artist design machine should preferably have the same specifications as the Viz Engine playout renderer, especially if the designers need to test performance issues on demanding scenes.

If designers are creating templates for Viz Pilot, it is recommended that Viz Pilot is installed on a separate machine for more accurate playout emulation on Viz Engine.

To run Viz Artist, the following software and configuration is needed:

Category	Requirement
Software	<ul style="list-style-type: none">• Viz Engine 3.5.1 or later, or Viz Engine 2.8 PL5 HotFix3.• Viz World Client 12.0 or later.• DataPool 2.10 or later Extra Viz Artist/Engine 2 plug-ins (for Viz Artist/Engine 2.x).• <i>Optional:</i> Mediaftp and fsmon are used for Viz One integration.• <i>Optional:</i> Viz Pilot with Template Wizard, Media Sequencer, Viz Multiplexer and Thumbnail Generator.• <i>Note:</i> Viz Engine 2.8 is not compatible with Viz One.
Executable(s)	<ul style="list-style-type: none">• viz.exe• VizGui.exe• vizSend.exe

Category	Requirement
Ports and Connections	<ul style="list-style-type: none"> • TCP: 6100 (preview and playout) • 14300 (Viz Multiplexer) • 50007-50009 (multiplexing).
Network access	Mapped drive to VOS still store folder and Viz Engine data root.

3.4 Ports and Connections

This section contains information on the following topics:

- [Port Numbers](#)
- [Multiplexing Ports](#)

3.4.1 Port Numbers

The table below lists all default server and listening port numbers that are used. It is, if possible, recommended to run the system on a network without a firewall.

Listener	Port(s)	Descriptions and comments
Mediaftp	21	Used for video transfers from Viz One to Viz Engine.
Viz One	22	TCP and UDP for logging in to the Viz One operating system (service: SSH).
Viz World Server	102 103	102 (TCP) is a Viz World Server listener port for Viz World Client connections when Server Allocator is not in use or only has one Viz World Server running. 103 (TCP) is a Viz World Server listener port for configuration tool connections to the first Viz World Server instance (as configurations are controlled by the first server instance). See also Vizrt Maps.
Viz One	137 139	Used for SMB file sharing (service: Netbios)
Viz One, Microsoft Bing and Imagery on Demand	80 8080	Web interface and client software. SOAP port for communication with Viz One. For download of Microsoft Bing and Imagery on Demand images. (service: HTTP)

Listener	Port(s)	Descriptions and comments
Viz One	443 445	(service: HTTPS)TCP & UDP used for SMB file sharing (service: Microsoft-DS).
Viz One Delivery	554	Real-time Streaming Protocol (service: TCP).
Oracle database	1521	For clients that connect to the Viz Pilot Database.
Sentinel HASP Run-time Environment	1947	The Sentinel HASP Run-time Environment uses port 1947 to communicate with local and remote components. This relates to Hardlock dongles used with Viz Curious Maps.
Viz One	3080	Low resolution video and index files (service: lighttpd).
Video servers	5250	MVCP and Xlator control port for video servers. Note: this port is only necessary in combination with the video server extension (service: AVCP).

Listener	Port(s)	Descriptions and comments
Viz Engine	6100 6700 6800 55001-55016 56000-56007	<p>Communication ports used by Control Applications (like Media Sequencer) to connect to a Viz Engine program and/or preview channel. Viz Engine's default program and preview port is 6100. In a single channel configuration where both program and preview output is on the same machine, the default preview port is set to 6800 in order to separate the program and preview channels.</p> <p>In a dual channel configuration, the default program ports are 6100 and 6800 for channel 1 and channel 2, respectively. In a dual channel configuration, when used for stereo production, the default program ports are 6700 and 6800 for channel 1 (left eye) and channel 2 (right eye), respectively.</p> <p>For controlling Graphics Channels and/or Superchannels, ports 55000-550016 and 56000-56007 are used. (can be changed in the config)</p>
Viz Trio	6200 6210	<p>6200 is used for controlling the Viz Trio client over a socket connection. 6210 is used by the Graphics Plug-in to establish a connection to Viz Trio.</p>
Newsroom Component	6220	Used by the Graphics Plug-in to establish a connection to Viz Pilot's Newsroom client.
Graphics Plugin Editor	6230	Used by the Graphics Plug-in to establish a connection to the Graphics Plug-in Editor (on Mac).
Graphics Plugin Config	6240	Used by the Graphics Plug-in to establish a connection to the Graphics Plug-in Configuration tool (on Mac).

Listener	Port(s)	Descriptions and comments
Ticker Service	6300 6301	Ticker handler in the Media Sequencer connects to port 6300 for feedback from Ticker Service. Ticker handler in the Media Sequencer connect to port 6301 when controlling the ticker via a socket connection.
Viz Pilot	6484	Socket connection used for controlling Viz Pilot using macro commands.
Viz One	6555	Message bus port for communication with Viz One (service: Message bus).
Preview License server	7452	For the Newsroom Component using an unlicensed Viz Engine for local preview with a connection to the Preview License server (is not the same as the Preview Server).
Viz Pilot Data Server	8177	Used to connect over http with the REST interface.
Media Sequencer	8580 8594	For clients connecting to the Media Sequencer. 8580 is specifically used to connect over http with the REST interface.
Viz One	8080	Used for sending key frames (service: ardok).
Gateway	10001 10002 10540 10541	For DB notification events.For Gateway controller clients.For MOS object updates.For MOS playlist updates.

Listener	Port(s)	Descriptions and comments
Viz World Server	10100 10200	10100 (TCP) is a Server Allocator listener port for Viz World Client connections, and is only used in order for clients to get connection details about Viz World Server(s). The first client connection will always be diverted to port 102. In case of multiple server instances port numbers are assigned according to a predefined schema (i.e. 10101, 10102 for server instance 2 and 3 and so on). In case there is no Server Allocator, Viz World Server will itself switch to port 102. 10100 (UDP) is a Viz World Server listener port for Server Allocator communication. 10200 (UDP) is a Server Allocator listener port for Viz World Server communication. Both UDP ports are internal ports used between the servers. For more information, please see the Viz World Client and Server 11.1 User's Guide and later. See also Vizrt Maps.
Viz Pilot	10640	Used by Gateway to establish a connection to Viz Pilot in order to send and receive updates on MOS messages (e.g. items and playlists).
Viz Engine	14300	Alternative port used to avoid conflicts with port 6100 (e.g. when using Viz Multiplexer). Port 6100 is normally used by renderers that are on air, hence, it is (e.g. when running Viz Pilot version 4 or Graphics Plugin towards Viz Artist /Engine 2.x) recommended to use another port. Port 14300 is an optional port. The default 6100 may also be used if the renderer is not used on air.
Graphic Hub	19392-19396	Ports in use when connecting to different Graphic Hub components.

Listener	Port(s)	Descriptions and comments
Connection Broker	21098	Connection to the Connection Broker configuration interface (e.g. http://localhost:21098/)
Viz Engine		Ports 50007 - 50009 are all Multiplexing Ports that enable Viz Engine to work on other scenes in sessions that are used for preview purposes:
	50007	MUX Isolated port: All connections to this port get its own session.
	50008	MUX Shared port: All connections from one single host shares one session.
	50009	MUX Fixed port: Same as shared port except that allocated resources are never cleared from memory.
	50010	Still Preview port: Enables a user to request a preview of the next scene to be put on air while another scene is on air.
Preview Server	54000	Used to connect over http with the REST interface.

3.4.2 Multiplexing Ports

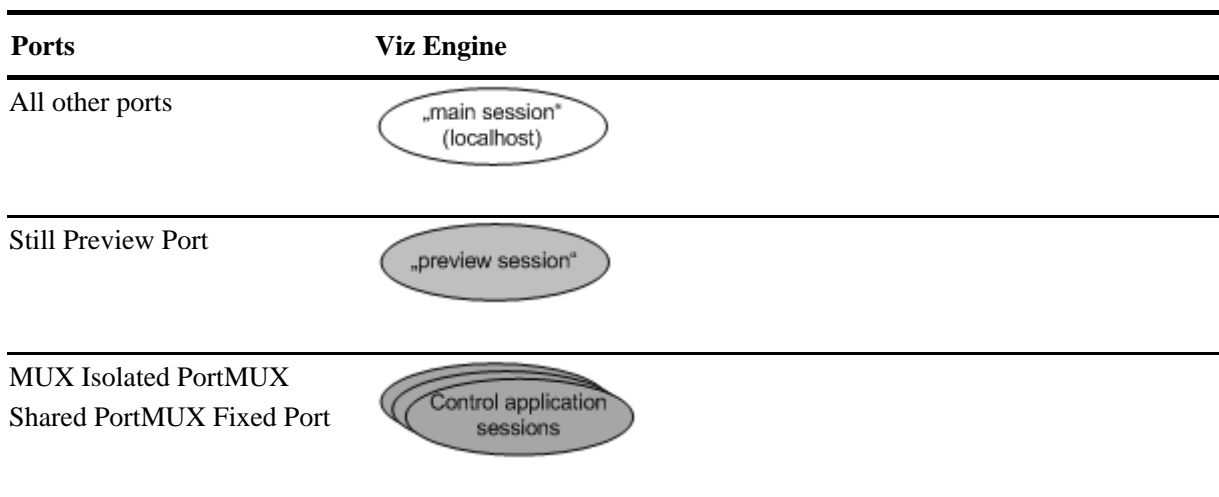

The multiplexer functionality is an integral part of Viz Engine. When using Viz Engine a session management takes place internally, with one default session for the GUI and internal/external commands, and additional sessions created on-demand for the multiplexing ports or the preview port.

With multiplex ports, other than the MUX Still Preview port, the Viz Engine state is only switched when a command is received, which means a new session is created; hence, ten consecutive commands from a client will only result in one state switch on the first command.

With the MUX Still Preview port the state is switched when a command is received and immediately switched back to the main session such that on air rendering will not be hindered in any way.

The MUX Fixed port is traditionally used by Viz Pilot Newsroom Client, and is the same as the MUX Shared Port, except that allocated resources are never cleared from memory. To avoid memory overload, it is recommended to clean up the Viz Engine regularly when this port is used.

The MUX Shared Port is a shared port where all connections from one single host shares one session. It is most often used by Viz Trio and the Newsroom Client to show preview frames.

The MUX Isolated Port is an isolated port where all connections get their own session. It is used, for example in an NLE configuration, to deliver frames to the host NLE-system when rendering or scrubbing video clips with graphics. Using this port will also suppress bounding box commands.

.....
Note: The MUX Isolated Port cannot be used by the Newsroom Component.
.....

All multiplexing ports are supported by all Viz Engine versions.

3.5 User Account Control (UAC)

Since version 3.7.1, Viz Engine/Artist is UAC aware. This means Viz Artist/Engine can run when UAC is enabled on the computer.

.....
IMPORTANT! UAC configuration is the responsibility of the individual company's own IT policy.
.....

When UAC is enabled, an additional confirmation prompt will show when these items are installed or removed:

- Viz Artist/Engine
 - Viz One Services (Mediaftp or fsmon)
 - The web service for the [Viz Engine REST interface](#)
- When UAC settings are modified, a reboot is required.

Viz Artist/Engine and all plug-ins shipped with the Viz Artist installer are UAC aware. However, if other plug-ins are used, a warning message may be displayed during Viz Engine startup:

WARNING: The plugin <plugin-name.vip> may not be UAC aware. Contact your plugin vendor for an updated version.

This warning means that the plug-in may not work correctly if UAC is enabled. For example, the plug-in might attempt to write into the installation folder, which is not allowed anymore.

Contact the plug-in vendor for information on the UAC awareness of the plug-in.

.....
IMPORTANT! Even though the warning shows, the plug-in is still loaded on startup.
.....

Most changes result from the UAC requirement that an application must not write into the installation folder.

3.6 Viz Artist and Engine Installation

Use the Viz Artist Bundle Installer to install both Viz Artist and Viz Engine. The bundle installer contains Viz Artist, Viz Engine, the license dongle drivers, and all required dependencies.

This section covers the following topics:

- [Installing Viz Artist and Engine](#)
- [Upgrading from a previous installation](#)
- [To change or reinstall an existing installation](#)
- [Silent installation of Viz Artist and Engine](#)
- [To identify installed architecture and version](#)

The software package is available in 32-bit and 64-bit versions. Most modern PCs should run the 64-bit version. Install the 32-bit version only on older PCs with 32-bit architecture, or computers running a 32-bit operating system.

The file name of the bundle installer indicates the architecture and software version in the following pattern:

- *Name-Architecture-Major.Minor.Maintenance.Build*

Where architecture can be either **x64** or **x86**. By common convention, x64 signifies the 64-bit version, and x86 signifies the 32-bit version.

Example: The file `VizArtistBundle-x64-3.9.0.99999.exe` is the bundle installer for Viz Artist and Engine version 3.9, for 64-bit architecture platforms.

3.6.1 Installing Viz Artist and Engine

Installation of Viz Artist and Engine requires elevated permissions on the destination computer. Make sure to log on to the computer with either an administrator account or a user account with elevated rights, before installing the software. See [Running Viz Engine and Viz Artist without administrator rights](#) for further details. If you install Viz Artist on a non-supported operating system platform, you will get a warning.

Before installing the software, make sure to:

- Check that your computer meets the [Prerequisites](#) for hardware and system configuration.
- Decide which of the [Viz Artist/Engine Platforms](#) is suitable for your installation.
- If upgrading, familiarize yourself with the information in the [Upgrading from a previous installation section](#).

Tip: Download the Viz Artist and Engine installer from Vizrt's FTP server.

1. Run the installer. The bundle installer provides an overview of all required dependencies that will be installed in addition to the main application. Already installed dependencies are listed as **Installed**. You can collapse the selection list by clicking **Settings**.



.....
Note: The bundle installer selects most features by default. Check the feature list and add or remove features as required.
.....

2. Scroll further down to select a custom installation location, if required.



3. Click install to complete the installation wizard. The various dependencies are installed as required.
4. Click **Finish**. If something interrupts the installation, click **Show log** to view the installation log files.

3.6.2 Upgrading from a previous installation

When you upgrade an existing installation to a new version of Viz Artist and Engine, observe the following:

- If upgrading an existing installation with the `VizArtist.msi` installation file, you will be presented with this message:
“Viz Artist 32bit is already installed.”

Remove the existing installation first, then restart the installer.”

Open **Uninstall a program** from the Control Panel, select Viz Artist and remove the existing installation. Then run the MSI file to install Viz Artist/Engine.

- Installing Viz Artist/Engine using the bundle installer will upgrade older installations. Any older version is removed, except versions prior to Viz Artist and Engine 3.6. This is true even if you opt to install Viz Artist/Engine in a different directory.
- You can only install one version of Viz Artist/Engine per architecture. This means:
 - You cannot install Viz Artist and Engine in parallel with older versions.
 - You can install a 32-bit version and a 64-bit version of Viz Artist/Engine in parallel.
 - Installing the 64-bit version will not upgrade any existing 32-bit version, and vice versa.
- The installer suggests installing to the previous installation folder. You may change it. The recommended installation directories are C:\Program Files (x86)\vizrt\Viz3 for the 32-bit application and C:\Program Files\vizrt\Viz3 for the 64-bit application.
- The installer pre-selects all previously installed features. You may change them.
- The installer does not support downgrading. Remove the currently installed version to install an earlier version of Viz Artist and Engine.
- Upgrading will not change any modified or newly added files of the old installation. For example, files like Configuration files, Log files or additional files like customer plug-ins, remain unchanged in their original folder.
- Since Viz version 3.7.1, viz.exe no longer checks the %Program Files% folder for Configuration files (.cfg) or Lens files (.lcb). These files must be located in %ProgramData%\vizrt\viz3.
 - If the previous Viz Engine/Artist was installed in the default folder, the Configuration and Lens files are automatically copied during upgrade from the default installation folder to %ProgramData%\vizrt\viz3.
 - If the previous Viz Engine/Artist was installed in a custom folder, the Configuration and Lens files needs to be copied manually from the old installation folder to %ProgramData%\vizrt\viz3.

3.6.3 To change or reinstall an existing installation

Use the Viz Artist bundle installer to change or reinstall an existing installation. The installer will pre-select any already installed features. Check the boxes for the components that you want to add or remove, then click **INSTALL**. This will reinstall the complete software suite, repairing any damaged or accidentally deleted files.

3.6.4 Silent installation of Viz Artist and Engine

The bundle installer does not support silent installation, which requires that you install each package separately. Extract all packages from the bundle by adding the /dump command line option.

```
C:\> Command Prompt
D:\Temp>VizArtistBundle-x64-3.9.0.99999.exe /dump
D:\Temp>cd "VizArtistBundle - 3.9.0.99999"
D:\Temp\VizArtistBundle - 3.9.0.99999>VizArtist.msi
```

This will create a sub-folder containing all packages contained in the bundle installer. Use the `VizArtist.msi` file located in this sub-folder for unattended installations. This is useful in large-scale enterprise deployment.

.....
IMPORTANT! The `VizArtist.msi` installation file does not support upgrades, and will terminate without installing. Enable logging and specify a log file to keep track of any issues during silent installation.
.....

1. Run the following from a command line prompt, or save it to a batch file for execution:

```
@rem silent installation
@rem platformtype: standardpc, video, trioboxcg, dualchannel
msiexec.exe /i <msi\_package> /quiet PLATFORMTYPE=<platformtype>
```

2. Enter `msiexec` on the command line and press enter to see other options. Common options are:

- **/i**: Installs or configures a product. Package: Specifies the name of the Windows Installer package file. ProductCode: Specifies the globally unique identifier (GUID) of the Windows Installer package.
- **/x**: Removes a product. Package: Name of the Windows Installer package file. ProductCode: Globally unique identifier (GUID) of the Windows Installer package.
- **/l, /log**: Enable logging. Make sure to specify the log file name.

.....
Example: `msiexec /i VizArtist.3.9.0.99999_32bit.msi`
`/norestart /passive PLATFORMTYPE=standardpc -lv`
`installation.log`
.....

3.6.5 To identify installed architecture and version

To check if Viz Artist is a 64-bit or 32-bit installation, click on the **Show License Information** button:

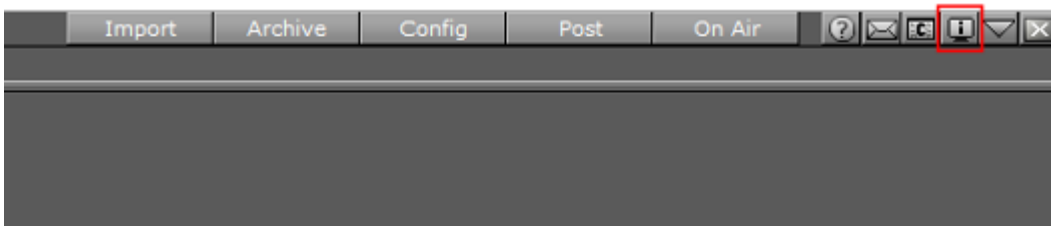

In the License Information window, the platform and Viz version number show as:

- **Platform:** Win32 (32-bit) or X64 (64-bit).
- **Viz Version:** 3.7.XX.XXX (Win32) or (X64).

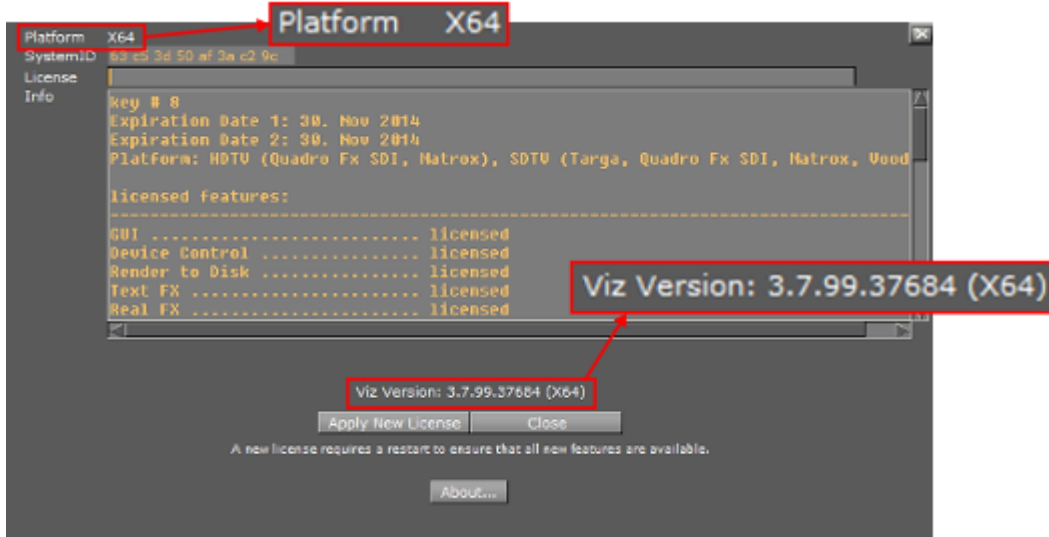

3.7 Viz Artist/Engine Platforms

Viz Artist/Engine can be installed and configured to use five different platforms. When Viz Artist/Engine is installed select which platform is required.

When Viz Trio One Box or Dual Channel versions are installed (with two GPUs), the Control GPU and Output GPU are selected by default. If required Viz Artist/Engine will run on one GPU only. The Control GPU must have a display connected and will be used for Artist/Preview.

The supported platform version options are:

- [VGA](#)
- [Video](#)
- [Trio Box CG](#)
- [Dual Channel](#)
- [Dual Channel VGA](#)

3.7.1 VGA

VGA is Viz Engine with VGA/DVI preview capabilities. This option has no support for any video hardware and has no live input or output options.

This configuration can, for example, be used for a Video Wall solution, Viz Frame Servers (for Viz NLE and Viz Pilot preview/still rendering systems).

3.7.2 Video

The Video option supports live input and output on SDI and/or IP, and typically provides **one program** output (fill and key on one channel). Preview without live video is available through VGA/DVI.

3.7.3 Trio Box CG

Trio Box CG (Character Generator) is a Video version with, typically, **one program** and **one preview** output (fill and key on two channels). To support program and preview output this option supports two graphics cards (see [Trio Box CG Mode](#)).

3.7.4 Dual Channel

Dual Channel is a Video version with, typically, **two program** outputs (fill and key on two channels). To support two program outputs this option supports two graphics cards (see [Dual Channel Mode](#)).

3.7.5 Dual Channel VGA

Dual Channel VGA is a Dual Channel version with additional VGA/DVI preview capabilities.

3.8 Install the Viz License

Viz Artist/Engine must have a license to operate. A license is normally acquired when the product is purchased. To get additional or updated licenses, contact your local Vizrt representative.

.....
Note: Some of the installed plug-ins are licensed separately.
.....

3.8.1 To Apply a Viz License in the GUI

Use this procedure to apply a first time license, apply a new license after a license expiry, or apply a new license before a license expires.

1. Make sure that the date and time on the computer is correct. The license is only valid for a certain time frame.
2. Insert the License dongle.
3. Start Viz Engine or Viz Artist.
4. Open the License window:
 - If this is a first time license application or the license has expired, the License window will open.
 - If this is a new license application before a license expiry date, click on the License Information button.

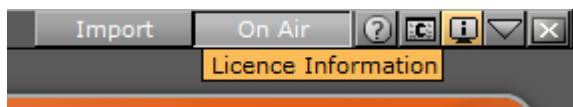

5. Check that the **Dongle ID**, in the License Information text file, is the same as the **System ID** in the License window.

LICENSE INFORMATION

Dongle-ID: 25 10 bd 48 b7 ef 42 da

License: FD 49 7B 65 05 E5 E7 81 01 25 28 C9 05 0E 57 FF 92 F0 79 C1 C8 6B B5 80 CE FF 19 88 85 25 2B 28

6. Check these details:

- Check that the license string has 32 pairs of characters and that they are divided by a single space.
 - Check the characters and for spaces at the end.
7. Copy the license string from the License Information text file.
 8. Paste the license string in the **License field** of the License window.
 - Check that the license key has not been entered twice.
 - Check that the whole string is pasted.
 9. Click **Apply New License**.
 10. Restart for the changes to take effect.

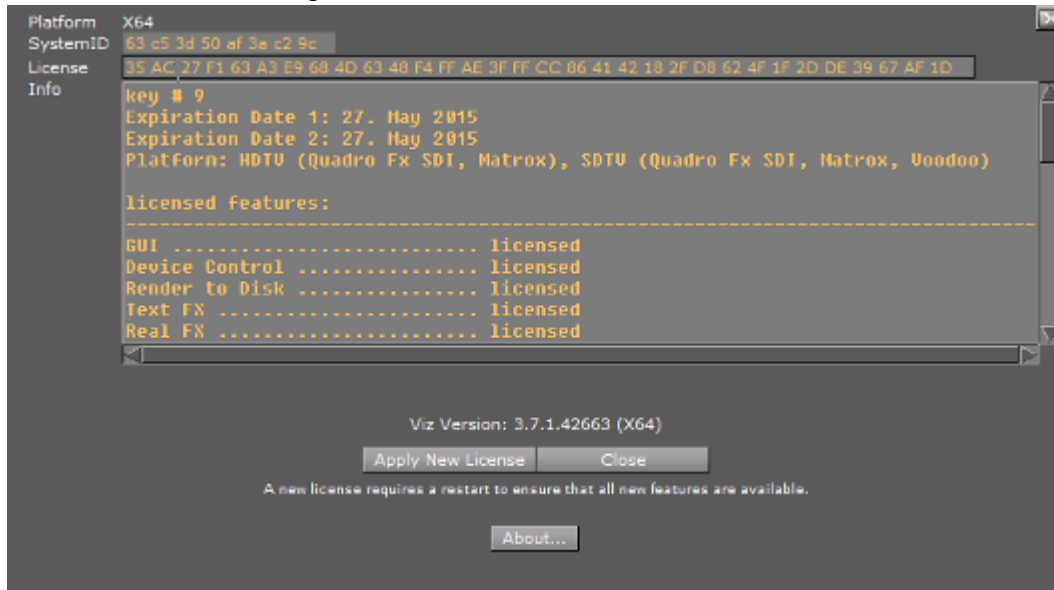

3.8.2 To Apply a Viz License in Viz Configuration

Use this procedure to apply new license before a license expires.

1. Make sure that the date and time on the computer is correct. The license is only valid for a certain time frame.
2. Insert the License dongle.
3. Open **Viz Configuration**.
4. Click on **Viz License Information**.
5. Check that the Dongle ID, in the License Information text file, is the same as the System ID in the Viz License Information panel.

LICENSE INFORMATION

Dongle-ID: 25 10 bd 48 b7 ef 42 da
License: FD 49 7B 65 05 E5 E7 81 01 25 28 C9 05 0E 57 FF 92 F0 79 C1 C8 6B B5 80 CE FF 19 88 85 25 2B 28

6. Check these License details:
 - Check that the license string has 32 pairs of characters and that they are divided by a single space.
 - Check the characters and for spaces at the end.
7. Copy the license string from the License Information text file.
8. Paste the license string in the **License** field of the Viz License Information panel.

- Check that the license key has not been entered twice.
 - Check that the whole string is pasted.
9. Press <ENTER>.
 10. Click **Save**.
 11. Restart for the changes to take effect.

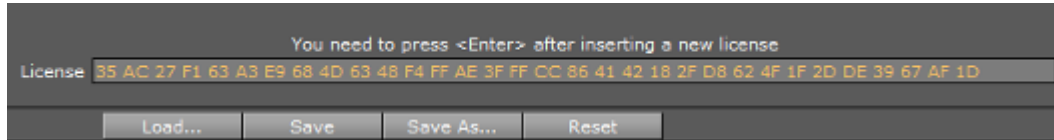

3.8.3 To Apply a Viz License with the Viz Console

Use this procedure to apply new license before a license expires.

1. Make sure that the date and time on the computer is correct. The license is only valid for a certain time frame.
2. Insert the License dongle.
3. Start Viz Engine, Viz Artist or Viz Config.
4. In the Viz Console enter the text `send KEY SET [full license string]`.

Tip: In Viz Artist or Viz Engine, click on  to view the Viz console.

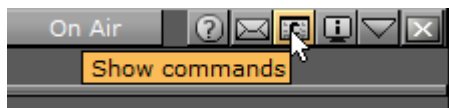

5. Press <Enter>.
6. Restart Viz Artist/Engine for the changes to take effect.

3.9 EVS Video Server Control

An EVS Control Plug-in lets the Viz Engine control an EVS video server (like a tape deck over RS422). This gives Viz Engine the ability to load and control playback of EVS video server clips.

This section contains information on the following topics:

- [Setup Requirements](#)
- [RS422 and XtenDD35 Configuration](#)
- [RS422 pin-out for the connector cable](#)
- [RS422 Controller Set Up Examples](#)
- [Bluestorm LP PCI card configuration](#)
- [ExSys EX-1303 USB to RS422 connector configuration](#)

3.9.1 Setup Requirements

- The computer which runs the Viz Engine must be equipped with an RS422 controller that maps the controller ports to the Windows COM ports.
- The RS422 port must be connected to an RS422 remote controller port of the EVS video server.

- The EVS player, controlled by the RS422 port, must be set up to use the protocol *XtenDD35* (No other protocol is currently supported).

3.9.2 RS422 and XtenDD35 Configuration

1. You need a RS422 controller that installs the RS422 port as a new COM port in Windows.
2. Set up the *XtenDD35* protocol on the used remote port of the EVS video server.

.....
IMPORTANT! This must be done before an attempt to connect.

3. Manually set the Windows COM port settings to:

- *38400 baud*
- *8 bytes*
- *one stop bit*
- *odd parity*

.....
IMPORTANT! This must be set before Viz Artist is started.

4. Usually, a special RS422 cable is required to connect the controller to the EVS video server. It is recommended to use a connector cable to connect the RS422/DB9 connector to a standard RS422 cable. The RS422 cable should work with a normal EVS video server controller.
5. Every RS422 controller has a different pin-out setting and requires a different connector cable. The table below shows which signal of the RS422 controller must be connected to which pin on the EVS side:

3.9.3 RS422 pin-out for the connector cable

Signal type of RS422 controller	Cable pin on EVS side
RxD B+ (in)	7
TxD B+ (out)	3
TxD A- (out)	8
RxD A- (in)	2
Sig Ref / Gnd	1

3.9.4 RS422 Controller Set Up Examples

The connection of a RS422 controller to the EVS is always different for each controller. Here are just two examples:

3.9.5 Bluestorm LP PCI card configuration

Viz Engine side (Bluestorm LP card)	EVS side		
Signal type	Pin	Pin	Signal type

Viz Engine side (Bluestorm LP card)	EVS side		
TxD+	2	3	RxD+
TxD-	3	8	RxD-
RxD-	4	2	TxD-
RxD+	1	7	TxD+
Sig Ref	5	1	Sig Ref

3.9.6 ExSys EX-1303 USB to RS422 connector configuration

Viz Engine side (ExSys EX-1303)	EVS side		
Signal type	Pin	Pin	Signal type
TxD+	2	3	RxD+
TxD-	1	8	RxD-
RxD-	4	2	TxD-
RxD+	3	7	TxD+
Sig Ref	5	1	Sig Ref

3.10 Dual Channel Mode

This section details how to configure the Dual Channel platform of Viz Artist/Engine (see [Viz Artist /Engine Platforms](#)).

Dual Channel is a video version with, typically, **two program** outputs (fill and key on two channels). To support two program outputs this option requires two graphics cards.

Once installed and configured, open the two Viz Engine consoles and add commands as required, or use an external application (for example Viz Trio or Viz Pilot) to control the Viz Engine.

See also the [Viz Trio User Guide](#) and [Viz Pilot User Guide](#).

3.10.1 To Configure Dual Channel

1. Install Viz Artist and select **Dual Channel** mode.

Dual Channel installs and adds these icons to the desktop:

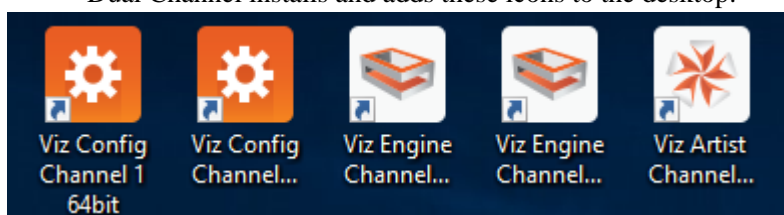

2. Open the **Viz Config Channel 1** application.

3. In **Database**, set **Auto log in** to **Yes** (active).
4. Click **Load...**

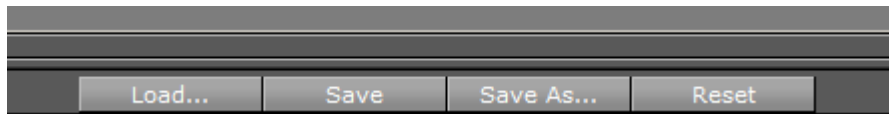

5. Select <viz install folder>/Configuration Profiles/dualchannel-0.cfg and click **OK**.
6. Configure Viz Artist/Engine as required, by setting the **Output Format**, etc. Then click **Save** and exit Viz Config.
7. Open the **Viz Config Channel 2** application and repeat the above steps to configure the second channel, using the dualchannel-1.cfg configuration file.

3.11 Trio Box CG Mode

This section details how to configure the Trio Box CG (Character Generator) platform of Viz Artist /Engine (see [Viz Artist/Engine Platforms](#)).

Trio Box CG mode is a video version with, typically, **one program** and **one preview** output (fill and key on two channels). To support program and preview output this option requires two graphics cards.

Once installed and configured, use Viz Trio to control the Viz Engines.

3.11.1 To Configure Trio Box CG

1. Install Viz Artist and select **Trio Box CG** mode.

Trio Box CG installs and adds these icons to the desktop:

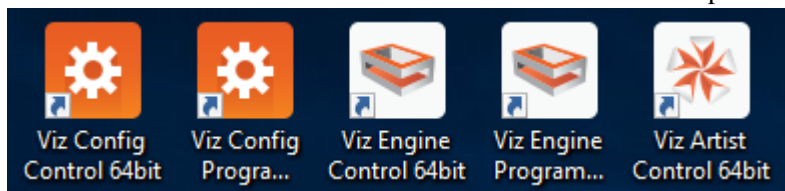

2. Open the **Viz Config Control** application.
3. In **Database**, set **Auto log in** to **Yes** (active).
4. Click **Load...**

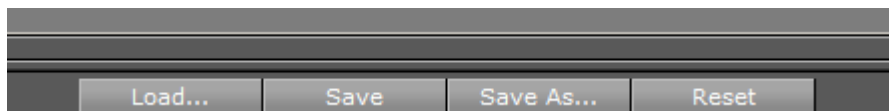

5. Select <viz install folder>/Configuration Profiles/trioonebox-0.cfg and click **OK**.
6. Configure Viz Artist/Engine as required, by setting the **Output Format**, etc. Then click **Save** and exit Viz Config.
7. Open the **Viz Config Program** application and repeat the above steps to configure the second channel, using the trioonebox-1.cfg configuration file.

3.12 Integration with Viz One

Viz Engine can be integrated with Viz One so that video clips can be transferred, and monitored, to and from Viz One.

The following sections describe how to install the Transfer and Monitor services to the Viz Engine and how to enable clip playout.

A Viz One system, which is configured to communicate with the Viz Engine, must be running during the installation and configuration of the two services.

Administrator rights are required to complete the install (see [Prerequisites](#)).

This section contains information on the following topics:

- [Configure Viz Engine](#)
 - [To Configure the Viz Engine](#)
- [Install Transfer and Monitor Services on Viz Engine](#)
 - [To Install the Transfer and Monitor Services](#)
 - [To Remove the Transfer and Monitor Services](#)
- [Configure Local Preview of Video Files](#)

See Also

- [Prerequisites](#)
- *Viz One Administrator's Guide*

3.12.1 Configure Viz Engine

Viz Engine must be configured for the transfer and playing-out of video clips from Viz One.

To Configure the Viz Engine

1. Open **Viz Configuration**.
2. Click on **Output Format**.
3. Select the correct output format as used in Viz One.
4. Click on **Video Board**.
5. Set the **Viz Link** option to **On**.
6. Click on **Video Input**.
7. Make sure that at least one Clip Channel is active.
8. Click **Save**.
9. Restart Viz Engine.

3.12.2 Install Transfer and Monitor Services on Viz Engine

The **Mediaftp** (file transfer) and the **Fsmon** (file system monitor) Services are required for Viz One a Viz Engine to exchange data.

Both services are part of the Viz Artist installation, but must be installed (activated) or removed (deactivated) through the Viz Configuration.

.....
Note: If these Services are not required, make them unavailable when Viz Artist is installed. The Mediaftp Service will print some feedback to the Viz Engine Console. The Fsmon Service will not.

The files for Mediaftp and the Fsmon are installed into the folders:

- <viz install folder>\Fsmon
- <viz install folder>\Mediaftp

Log-files are written to the folders:

- <viz data folder>\Fsmon
- <viz data folder>\Mediaftp

To Install the Transfer and Monitor Services

.....
IMPORTANT! Make sure that the Clip Data Directory is set correctly before the services are installed (see [Video Board](#)).
.....

1. Open **Viz Config**.
2. Click on [Viz One](#).
3. In the **Days to keep log files** field, set the number of days log files are to be kept (default is 7 days).



4. **Fsmon** Service Only:
 - a. Enter the host name of the local host.
 - b. Enter the host name of the Viz One Message Queue Server.

.....
IMPORTANT! The local host name must be exactly the same string that was entered in the Viz One as host name for the Viz Engine (it must be the exact same string as seen beside Host on the Servers page).
.....

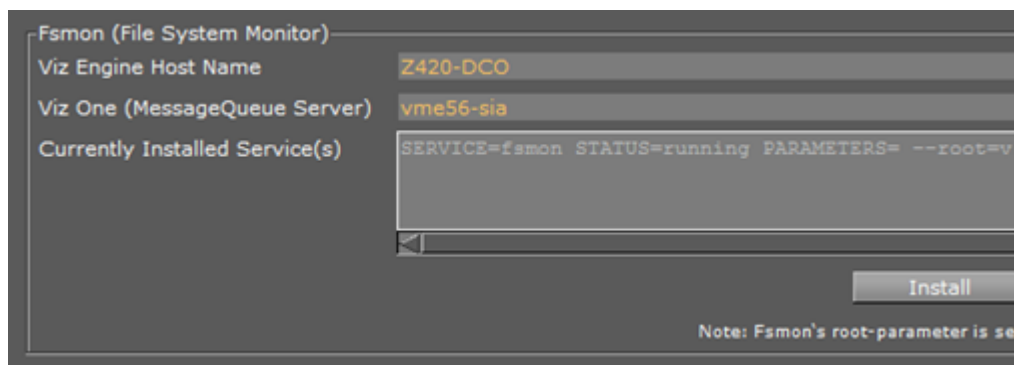

5. **MediaFTP** Service Only: Set the transfer band width (Kbits per second), as required.

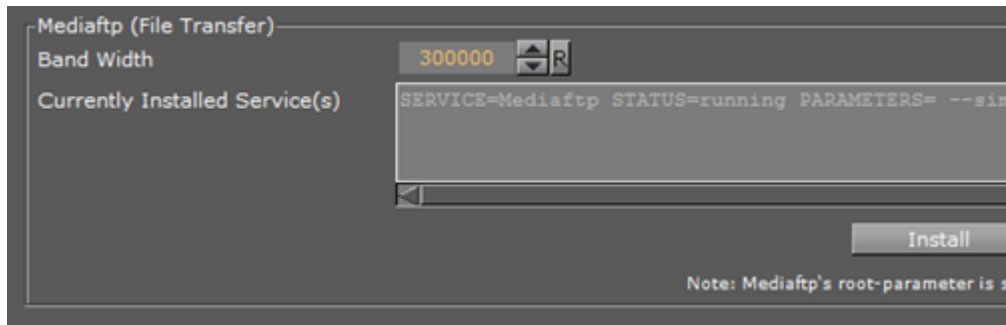

.....
Note: Mediaftp is installed with the **-a** flag. This assumes that the default Viz One user /password combination is: vtrsync/vtrsync. Mediaftp will install, but not work, if the user /password combination is different (see **Adding a Viz Engine** in the Viz One Administrators Guide).

6. Click on **Install** for each required Service.

.....
Note: Any currently installed Services must be removed before a new Service can be installed.

To Remove the Transfer and Monitor Services

.....
Note: When a Service is removed, the Service is made **inactive**. The Service is still available, and if required again, click **Install** to make **active**.

1. Open **Viz Config**.
2. Click on **Viz One**.
3. Click on **Uninstall** for each required Service.

3.12.3 Configure Local Preview of Video Files

If a Viz Engine is used for local preview (for example, Viz Engine installed on a control client machine) the FFDSHow codec package and a Matroska splitter, must be installed.

.....
Note: The procedures, detailed below, are only relevant for low resolution versions of video clips to be previewed on Viz One. In most cases this happens when control applications, such as Viz Trio, are used to, for example, preview a full screen clip. High resolution video clip versions do not need this codec installation.

The following procedures will guide you through the necessary installation steps:

- [To Install Codecs for Local Preview](#)
- [To Set a Preferred Decoder](#)
- [To Register the Matroska Splitter](#)
- [To Unregister the Matroska Splitter](#)
- [To Configure Preview of Clips Stored on Viz One](#)

To Install Codecs for Local Preview

After the FFDSHOW codec package has been installed:

- Make sure that Viz Engine or generally no applications are excluded (there is an inclusion and exclusion list in FFDSHOW)
- Make sure that there are no other codec packages installed on the machine that will interfere with FFDSHOW or the Matroska splitter.

.....
Note: A license is required for clip playback as FFDSHOW does not come with a decoding license.
.....

1. Start the browser.
2. Search for and download:
 - The FFDSHOW M PEG-4 Video Decoder

.....
IMPORTANT! Make sure a license is available to use the codec and that the 32-bit version of the codec is downloaded
.....

- The Matroska Splitter
 - The Windows 7 DirectShow Filter Tweaker
3. **Remove** older **64-bit** versions of the **MPEG-4 codec**
 4. Extract:
 - The **Matroska Splitter**, and
 - The **Windows 7 DirectShow Filter Tweaker**.
 5. **Install** the **MPEG-4 codec**.
 6. Set your **MPEG-4 32bit decoder** to **FFDSHOW**.
 7. Register the Matroska Splitter.

To Set a Preferred Decoder

1. **Run** the **Windows 7 DirectShow Filter Tweaker**
2. In the appearing dialog box click **Preferred decoders**

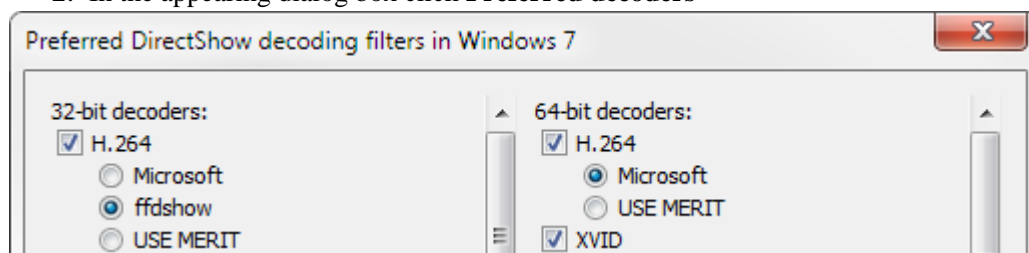

3. Set your **MPEG-4/H.264 32-bit decoder** to **FFDSHOW**.
4. Click **Apply & Close**.
5. Click **Exit**.

To Register the Matroska Splitter

1. Extract the **Matroska Splitter**

2. Copy the **ax file** to your C:\Windows\System32 folder

.....
Note: There are two files available, one in the root folder that is used for 32-bit systems, and one in the x64 folder used for 64-bit systems.
.....

3. Click on *Start > Run*

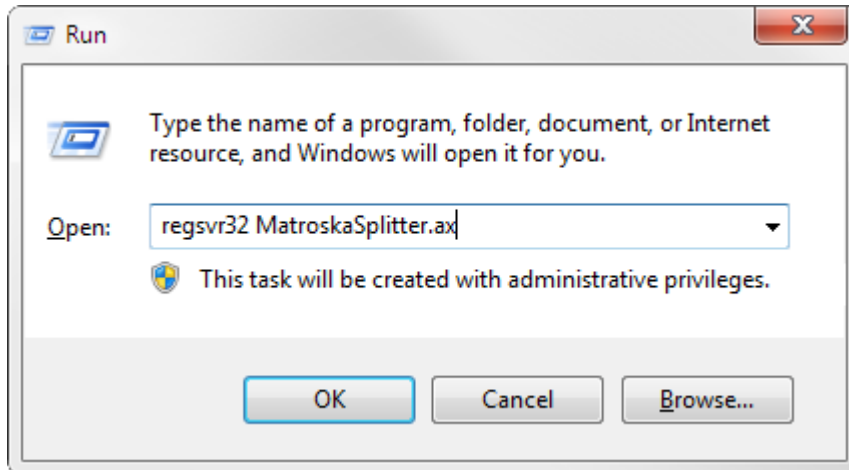

4. Enter **regsvr32 MatroskaSplitter.ax**.
5. Click **OK**. A message box appears confirming your registration.
6. Click **OK**.

To Unregister the Matroska Splitter

1. Click on *Start > Run*
2. Enter **regsvr32 -u MatroskaSplitter.ax**.
3. Click **OK**. A message box appears confirming that it is unregistered

To Configure Preview of Clips Stored on Viz One

If the **VGA version** is installed, do these steps:

1. Open Windows Explorer
2. Open the Viz Config file
3. Locate SECTION VIDEO
4. Set vizlink_mode = 1
5. Save the file

If the **Video version** is installed, do these steps:

1. Start Viz Config
2. Select the **Video Board** section and enable (*On*) the **Viz Link** option
3. Click **Save**.

3.13 Viz Engine REST interface

REST (short for Representational State Transfer) is an architectural paradigm for distributed systems, such as web services. Broadly spoken, REST relates to HTTP in the sense XML relates to HTML; a paradigm of the general concepts behind HTTP with some added restrictions. One such constraint is the statelessness of the communication; which HTTP violates via cookies.

The most widely known application of REST, are web pages accessed via HTTP. Each web page is a unique resource, accessed via it's URL (Uniform Resource Locator) which can be operated on (for example GET /books/dune.html). This combination of operation and URL is called a message. In REST, a message has to be self-descriptive, meaning that all the information needed to process the message is required to be contained within the message.

The Viz Engine REST interface can be activated by enabling **Webservice** in the [Communication](#) section of [Configuring Viz](#).

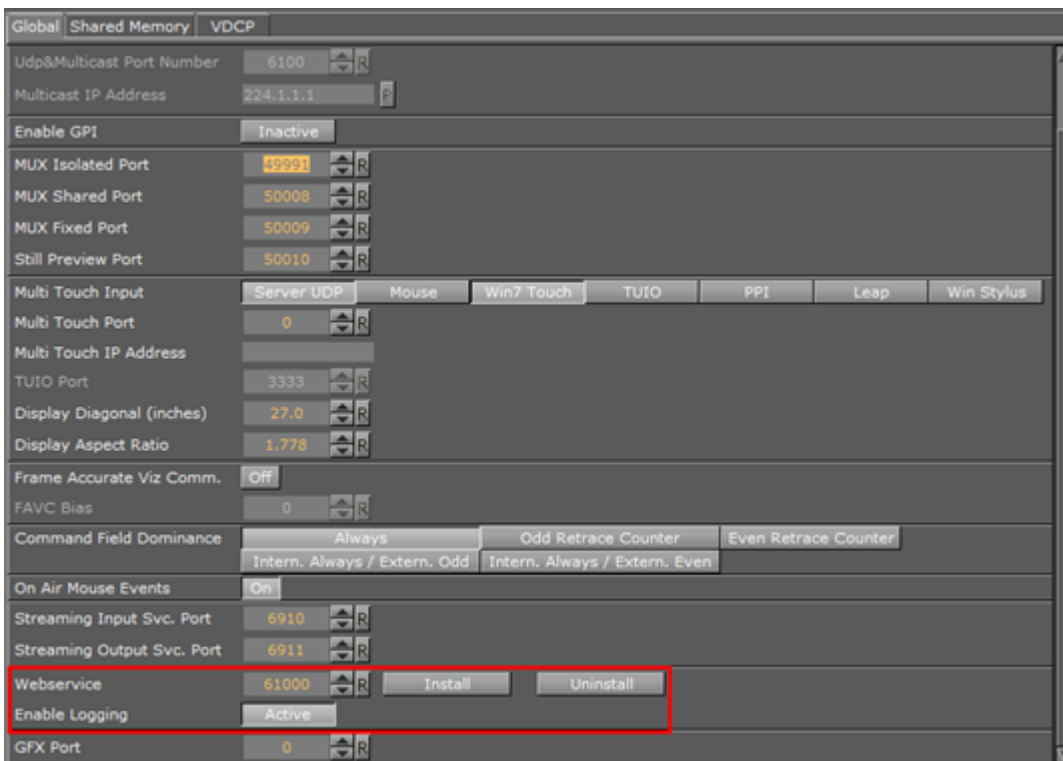

If [User Account Control \(UAC\)](#) is active, press **Install** after setting the Port. The default port for the Viz Engine web service is 61000. After restarting VIZ, the REST interface can be accessed by navigating a web browser to `http://localhost:61000`. The landing page will display the status of the Engine, with information on which mode it is running in and its version number.

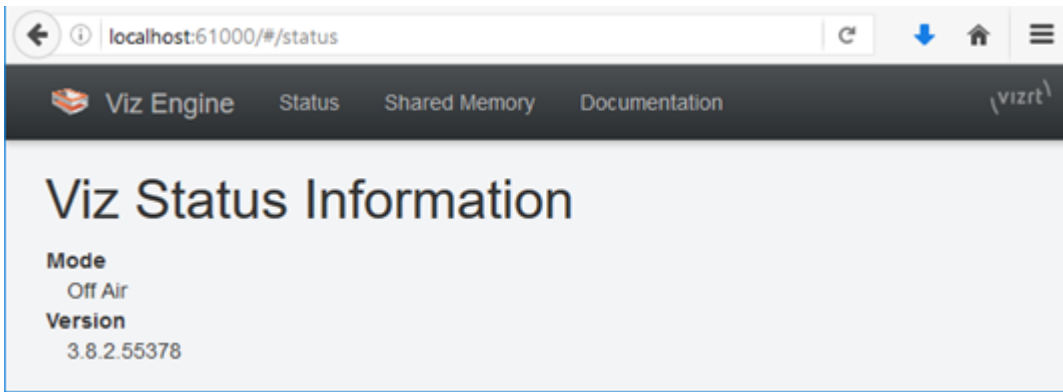

Once the REST interface has been activated, the complete documentation for the Viz Engine REST interface can be accessed by navigating to `http://localhost:61000/#/documentation`, or by clicking the **Documentation** link from the landing page.

3.14 Dolby E Support

Viz Engine is certified by Dolby for decoding Dolby E streams from the inputs into the Viz Engine, and encoding the first eight audio channels back to Dolby E on the output.

This section contains the following topics:

- [Dolby E Features](#)
 - [Dolby E License](#)
- [Dolby E Configuration](#)

3.14.1 Dolby E Features

The Dolby E feature set in Viz Artist/ Engine is defined as follows:

- Dolby E is supported on Matrox Video I/O hardware only
- Dolby E is supported both as AES or embedded audio on the input and output side
- Decoding of one Dolby E stream (minimum eight/maximum 16 Dolby E channels) on all inputs.

.....
Note: The Dolby E stream (encoded in a stereo pair) must be on the first two AES or embedded audio channels
.....

- Encoding of one Dolby E stream (minimum eight/maximum 16 Dolby E channels) on the fill output.

.....
Note: The Dolby E signal is encoded on the first two AES or embedded audio channels on the output.
.....

- All audio channels from the Viz timeline can be mixed, as usual, with the decoded Dolby E signal from the inputs, and will be output together with the input audio as Dolby E
- Dolby E encoding and decoding can be configured independently, i.e. it is possible to input PCM audio and output Dolby E or vice versa
- You can also have PCM audio on one or more inputs and Dolby E audio on different input and mix them together

- Dolby E decoding from clip channels is **not** supported

Dolby E License

Each Dolby E stream processed in the system requires a license

For example if there are two input signals with Dolby E and the output is to deliver Dolby E as well, two decoder and one encoder licenses are required.

The Dolby E licenses are software licenses which reside on a software dongle and can hold multiple licenses for one system.

3.14.2 Dolby E Configuration

This section details the set up required in the Viz Config file and GUI.

This section contains the following procedures:

- [To Enable Dolby E Functionality](#)
- [To Set Audio in Channels as Dolby E Inputs](#)
- [To Enable Dolby E Encoding](#)

To Enable Dolby E Functionality

The Dolby E signal can be present in the embedded audio of the video signals, or on the AES inputs of the Matrox card.

1. Open the Viz Config file.
2. Set **DolbyEEnabled** to 1

To Set Audio in Channels as Dolby E Inputs

The Dolby E stream must be present in the sub-channel 0 and sub-channel 1 of the input.

1. Open the Viz Config file.
2. Configure these settings as shown:
 - ChannelDolbyEEnabled__0 = 1
 - ChannelDolbyEEnabled__1 = 0
 - ChannelDolbyEEnabled__2 = 0
 - ChannelDolbyEEnabled__3 = 0
 - ChannelDolbyEEnabled__4 = 0
 - ChannelDolbyEEnabled__5 = 0
 - ChannelDolbyEEnabled__6 = 0
 - ChannelDolbyEEnabled__7 = 0

To Enable Dolby E Encoding

This enables the encoding of the first eight internal audio channel to a Dolby E stream which will be sent to the output.

- Set **DolbyEOutput** to 1

Note: Only live video inputs are supported.....





- To Enable Dolby E Functionality
- To Set Audio in Channels as Dolby E Inputs
- To Enable Dolby E Encoding

4 Starting Viz Engine

To start and run Viz Engine, you need to connect to an available Graphic Hub.

Viz Engine can also be started with various options included (see [Viz Command Line Options](#)). To start Viz Engine with an option or options, the command for that option must be added before Viz Engine start-up.

4.1 To Start Viz Engine

1. Start Viz Engine
2. In the Graphic Hub login window, provide the required details:
 -  : Select a Host from the drop-down list. You can also type the host name, if the host does not appear in the list. This may happen if the server is on a different sub-net.
 -  : Select a Graphic Hub from the drop-down list.
 -  : Select a User from the drop-down list.
 -  : Type the correct password for the selected User.
 - **Log me in automatically:** If auto log in is available, click to enable automatic log on. This makes Viz Engine automatically connect and log on to a pre-defined Graphic Hub on start-up.
3. Click **Log in**.

4.2 To Add a Viz Engine Startup Option

1. Right click the Viz Engine icon and select **Properties**.
2. In the **Shortcut** pane, apply a command in the **Target** field (see [Viz Command Line Options](#)).

.....
Example: "<viz install folder>\3.xx.x\viz.cmd" -n
.....

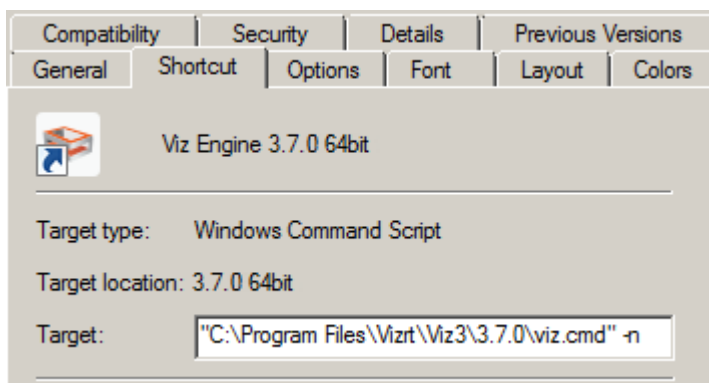

3. Click **OK**.
4. Start Viz Engine.

4.2.1 Viz Configuration

Viz Artist/Engine is mainly configured by the [Configuring Viz](#) application. All configuration settings are stored in the Viz Config file, found in the `<viz data folder>`. The Viz Config file uses the machine host name to uniquely identify which machine Viz Artist/Engine is installed on, as for example, `Viz-<hostname>-0-0.cfg`.

Any changes to the host name will affect the Viz Artist/Engine. If a host name is changed, a new Viz Config file is created with a default setup. The old Viz Config file is not deleted, but left unused. If required, use the command `-g <configuration file>` (see [Viz Command Line Options](#)) to reassign the old Viz Config file.

.....
IMPORTANT! Do not use the Hash tag (#) in any folder, file or path name, as Viz Engine ignores text following a Hash tag.
.....

4.3 Viz Console

The Viz Console window is mainly used for debugging purposes, to display information about the running Engine or connected Graphic Hub, and for manually sending commands directly to the Engine. The Viz Console shows the commands that are used in communication between the Viz Engine renderer and other components, such as Viz Artist, External Control Applications, plug-ins, and scripts.

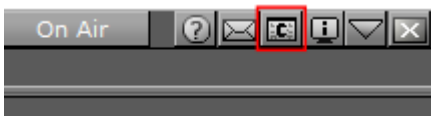

For an overview of the available commands, open the console window and type `? or help`, then press enter. This will output a list of the available console commands. The complete documentation for the command interface is included with the Viz installation, and can be found under

`<Viz Install Folder>\Documentation\CommandInterface.`

.....
IMPORTANT! The Viz Console is case sensitive.
.....

4.3.1 Issuing External Commands to Viz Engine via Console

External Control Applications, such as Viz Trio and Viz Pilot, communicate with Viz Engine through External Control commands. Viz Engine supports a wide range of such commands. Any installation of Viz Engine and Artist also come with the application **Viz Send**, which mimics the behavior of External Control Applications.

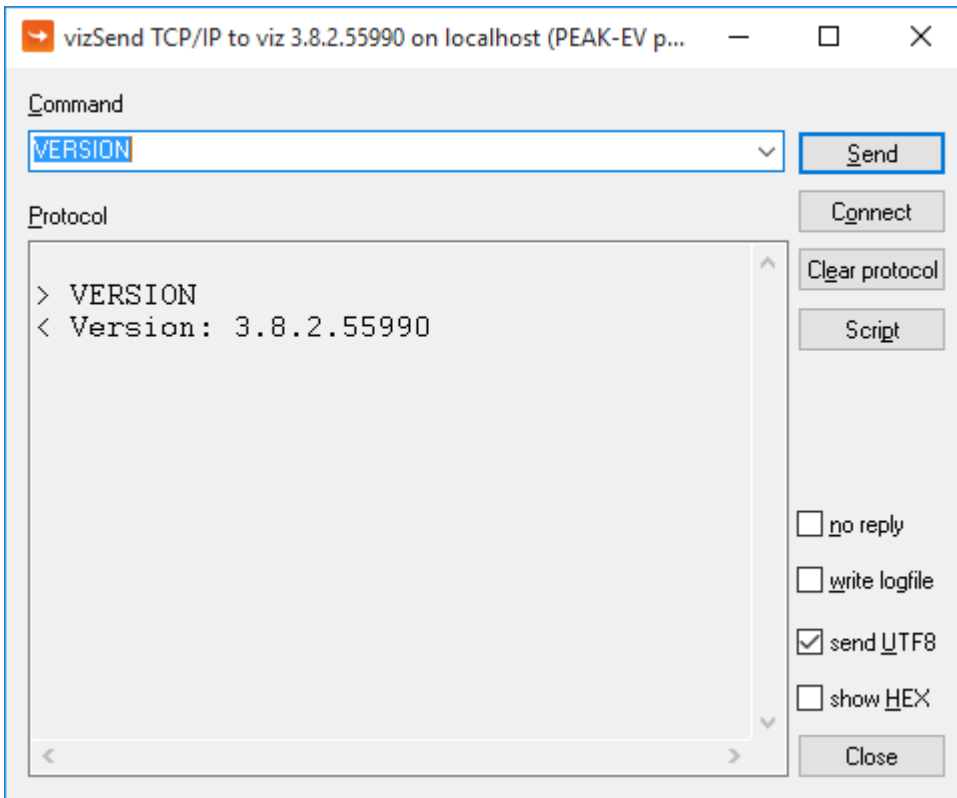

External Commands can also be sent manually to Viz Engine through the console window, using the `send` command. External commands range from loading a scene and taking the scene on air, to shutting down Viz Engine. To issue a command to the Engine, open the console window and type `send [COMMAND]`, then press enter. For example, the command `VERSION` can be used to display the current Viz version and build number:

```
send VERSIONCONSOLE: answer <Version: 3.8.2.55990>
```

Most commands also have a subset of commands. All commands in the Engine follow a specific syntax, and can be passed either properties or further commands. The general syntax structure is:

```
[Leading flag] [Location] [Command] [Value]
```

Locations and commands may also have sub-locations or subsets of commands, respectively, in which case an asterisk serves as the divider between each part. Please see the examples below for a better understanding of how to address these.

- **Leading Flag:** Define if Viz Engine should send a reply to the command being issued. A leading `-1` indicates that no reply is required. Positive integers, including `0`, serve as a command ID. This allows an external control application to match the reply to the corresponding command request, if several commands are sent simultaneously.

- **Location:** The location can be the main object, configuration, an object ID, one of the object pools, a container or geometry, a key-frame, a shared memory (SHM) location, a layer, and so on. In addition, the location can be any command or property of such. In essence, anything in Viz could serve as the location for a command.

As an example, a scene can be loaded into any one of the three layers in Viz; **Back** layer, **Main** layer and **Front** layer. The layers can be addressed by name:

- RENDERER*MAIN_LAYER
- RENDERER*FRONT_LAYER
- RENDERER*BACK_LAYER

In addition, the scene can be accessed directly by referring to the scene via its database path, UUID, REST URL or temporary object ID:

- SCENE*SceneLocation
- **Command:** The Command part of the syntax can consist of either a property or another command.
- **Value:** The value for the command, which can be for example a numeric value, a location or a state.

.....
Tip:COMMAND_INFO is a very useful command, used to display help on any other command or subset. For example, passing the command send RENDERER COMMAND_INFO will display a list of all available properties and commands for the **RENDERER** command, while RENDERER*BACKGROUND will display properties and commands for the **BACKGROUND** sub-command of the RENDERER command.

Viz Engine can address locations in three ways, by either **UUID**, **Path** or **REST**:

- **UUID:** Universally Unique Identifiers are always provided angle brackets, for example <1A85AC97-00AE-E74B-A236EDA262D69908>.
- **Path:** The full path to the item, as seen in Viz Artist.
- **REST:** In addition to the built-in [Viz Engine REST interface](#), Viz Engine also interprets Graphic Hub REST URLs as part of commands. Even though the commands themselves are case sensitive, the host names and UUIDs in REST URLs are not. The URLs may also contain special characters, like a forward slash.

These are all valid as locations when passing commands to Viz Engine, although they change the appearance of the command itself. Here is an example command setting an image as background image for the loaded scene, for each location method: **UUID**:

```
RENDERER*BACKGROUND*IMAGE*IMAGE SET IMAGE*<1A85AC97-00AE-E74B-A236EDA262D69908>
```

Path: RENDERER*BACKGROUND*IMAGE*IMAGE SET IMAGE*01_DOC_EXAMPLES/Images/Bear

REST: RENDERER*BACKGROUND*IMAGE*IMAGE SET IMAGE*http://GH\SERVER:19398/image/1A85AC97\00AE\E74B\A236EDA262D69908/Bear

.....
Tip:Object IDs are temporary shortcuts created on the fly when an item is loaded into memory, and removed when unloading the item or restarting Viz. To get an objects Object ID, pass the **GET** command to the **OBJECT_ID** location of the object. For example: MAIN_SCENE*OBJECT_ID GET.

4.3.2 Internal Commands

For ease of use, internal commands can be set to be hidden or visible. Under certain circumstances, some plug-ins may need to send commands on every frame. This can leave the Viz Console window "flooded" with text, leaving it unreadable. By default, internal commands are hidden, meaning these messages will not be output to the console window. To see all internal commands by default, the Viz configuration file must be manually edited, setting `show_internal_commands` to 1. During normal operation, however, it would usually suffice to temporarily activate the output of internal commands to the console, by clicking the  (Show Commands) icon in the Viz Artist or Viz Engine GUI. This will also make the console window stay always on top, meaning it will not be hidden behind other full-screen applications, such as Viz Artist or an Engine in [On Air Mode](#).

4.4 Viz Command Line Options

You can start Viz Artist and Viz Engine with various [startup options](#). These command line parameters must be passed to the Viz batch file, `viz.cmd`, and not to the executable file, `viz.exe`. The table below details the most common Viz Command Line Options. You can get a list of all available startup options, by running `viz.cmd -h` or `-?` from the command line.

Command	Description
-3D	To playback 3D Stereo Clips. This sets Viz Artist in a special mode where a side by side clip will be split and played out on channel A and B on the Matrox board. Note: This is for clips only
-B <path>	Specify the path where Viz Engine stores its temporary data (see Viz Artist /Engine Folders)
-c	Start in Viz Configuration mode (see also -u1, -u2, -u3)
-C	Start without a console.
-db user:password@server /naming-server:port	Specify which Graphic Hub to connect to on Viz Engine startup. password can be omitted from the argument, but user, server, naming-server and port must always be provided. Example: <code>viz.cmd -db Guest:@VizDbServer /localhost:19396</code> In the example above, Viz Engine will connect to a Graphic Hub server called VizDbServer on the naming-server localhost at port 19396 , as the user Guest with no password.
-g <config file>	Start with a predefined Viz Config file. This allows a User to have more than one startup option
-i	Enable pre-initialization of textures. Textures are generated on the graphics card immediately after loading an image
-l	Specify a console title to distinguish Viz Engines in a Dual Channel setup (example: <code>-l <title></code>)
-n	Start in Viz Engine mode (see also -u1, -u2, -u3)

-o <scene>	
-o <layer> <scene>	
-t	Enables non-interactive mode for all occurrences except dongle issues and sound driver setup.
-T	Keep the Viz Engine Console always on top
-u1, -u2, -u3(up to a maximum of 24)	For systems with two or more graphic cards (i.e. Trio One Box / Dual Channel). Specify GPU1 (-u1), GPU2 (-u2), etc., to run Viz Artist on. See Systems with Two or More GPUs below.
-v	Enable verbose mode. This enables all possible information to be shown in the Viz Engine Console
-V	Legacy: Show the last rendered frame on video output (only Digital Voodoo cards)
-w	Start in Videowall mode.
-x	Start without any GUI
-Y <path>	Specify the path where Viz Engine stores its program data (see Viz Artist /Engine Folders)

4.4.1 Systems with Two or More GPUs

It is possible to specify which GPU Viz Engine should run on, by providing the flags `-u1` and `-u2` for GPU1 and GPU2, respectively. A maximum of 24 GPUs are supported. This allows the system to run the Engine on one GPU while running Viz Config on another, for example:

- `<viz install folder>\viz.cmd -c -u2`
- `<viz install folder>\viz.cmd -n -u1`

More than one Viz Engine can run on one GPU (multiple Viz Engines can not run on the GPU with the same port number), use the formula `m%n` to calculate which Viz Engine instance to use (Viz Engine defined by `-u<m>`). Note, however, that Viz Artist can only run on Viz Engine instance 1 (`-u1`). Only the control GPU should have a display connected and will be used for Artist/Preview.

- Formula: `m%n`
 - `m = -u1/-u2/etc.`
 - `n = number of GPUs`

For example, two Viz Engines:
- System with 2 GPUs: Engines run on GPU2: Engine 1 (`-u2`) / Engine 2 (`-u4`)
- System with 3 GPUs: Engines run on GPU2: Engine 1 (`-u2`) / Engine 2 (`-u5`)

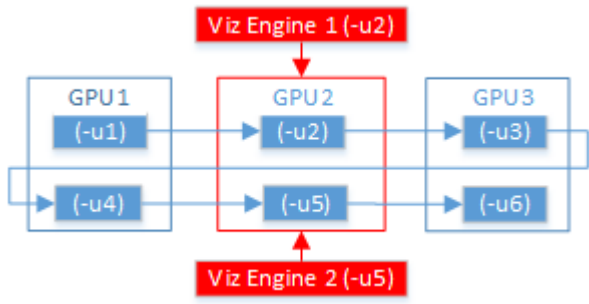

When either Trio One Box or Dual Channel Viz Artist versions are installed, GPUs are selected by default.

5 Configuring Viz

Viz Configuration is the configuration interface for Viz Engine and other applications that integrate with Viz Engine.

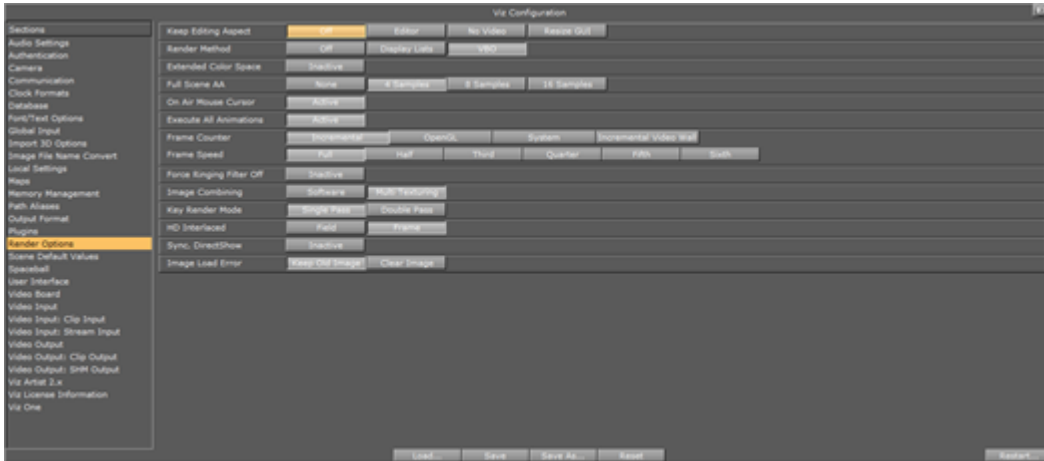

The Viz Configuration user interface is divided in two:

- **Sections:** Shows a list of all the sections available for configuration
- **Configuration Parameters:** Shows all available configuration parameters for each section
Various parameters regarding the program functionality can be set in the configuration.

Viz Artist/Engine is mainly configured with the Viz Configuration. However, all configuration settings are stored in a Viz Config file (located in the *<viz data folder>*). The Config file uniquely identifies the machine that Viz Artist/Engine is installed on by the use of its host name, for example *Viz-
<hostname>-0-0.cfg*.

Any changes to the host name will affect the configuration. If a host name is changed, a new Viz Config file is created with a default setup. The old Viz Config file is not deleted but left unused. If required, the old Viz Config file can be reassigned with the command *-g <configuration file>*.

.....
Caution: Make sure that any changes are saved before Viz Configuration is closed. Changes are not saved and will not take effect until Viz Artist has been closed and started again.
.....

5.1 Working with Viz Configuration

To configure Viz Artist and Engine, click the **Config** button in Viz Artist or start the Viz Configuration application from the Start menu.

Viz Artist/Engine also has a selection of [Installed Configuration Profiles](#). When the configuration profiles are saved, only the settings that differ from the default configuration of a setup (VGA mode, Video mode, etc.) is saved.

Viz Configuration adjusts its size to the current screen resolution when it opens. When running Viz Configuration without Viz Artist, it will check the resolution and limit the size to 1430 x 750 pixels. This is useful for high-resolution configurations, especially during [Video Wall Configuration](#).

5.1.1 To Start Viz Configuration

- Run Viz Configuration from the desktop shortcut or the Start menu.
- If Viz Artist is running, click **Config** or press <F11>.

5.2 Modify Viz Configuration

This section details how to Save, Save as..., Reset and Load Viz Configurations.

This section contains the following procedures:

- [To Save the Current Configuration](#)
- [To Reset the Viz Config File](#)
- [To Restart Viz Configuration](#)

5.2.1 To Save the Current Configuration

1. Start Viz Configuration.
2. Change the configuration as required.
3. Click **Save**.

.....
IMPORTANT! Changes made to the resolution can affect an in use IP streaming service.
Make sure to check the IP streaming service configuration.
.....

4. Click the **Restart...** button to apply the saved changes. The Viz Config file is updated.

5.2.2 To Reset the Viz Config File

The **Reset** button sets the configuration to default settings.

1. Start Viz Configuration.
2. Click **Reset**.
3. Click **Restart...** to apply the changes.

5.2.3 To Restart Viz Configuration

Click the **Restart...** button to save changes.

1. Click **Restart...**
2. Select from:
 - Current
 - Viz Engine w/GUI
 - Viz Engine w/o GUI
 - Viz Artist

- Viz Config

5.3 Installed Configuration Profiles

Viz Artist/Engine is installed with a selection of Configuration Profiles. These profiles are a set of predetermined basic settings to run Viz Artist/Engine for specific purposes, for example, [Dual Channel Mode](#), [Trio Box CG Mode](#) or a [Video Wall Configuration](#).

Once loaded into the Viz Configuration, these files can be modified to refine the profile to specific needs, which can then be saved.

The pre-installed Configuration Profiles are located in: <viz install folder>\Configuration Profiles.

5.3.1 To Load a Pre-Installed Configuration Profile

1. Start Viz Configuration.
2. Click **Load...** and select **Installed Profile**
 - The correct folder opens automatically.
3. Open the required Configuration Profile.
4. Click **Restart...** to load the Configuration Profile.

5.3.2 To Save a Custom Profile

A Configuration Profile cannot be saved to the <viz install folder>. A UAC requirement is that an application must not write to the installation folder (see [User Account Control \(UAC\)](#)). The default location for custom Configuration Profiles is %Programdata%\Vizrt\Viz3.

1. Start Viz Configuration.
2. Change the configuration as required.
3. Click **Save As...**
4. Select a location to save the new Configuration Profile. The default location is %Programdata%\vizrt\Viz3.
5. Type a name for the new Configuration Profile.
6. Click **OK**.

5.3.3 To Load a Custom Configuration Profile

1. Start Viz Configuration.
2. Click **Load...** and select **Custom Profile**
 - The correct folder opens automatically
3. Locate a saved Configuration Profile (*.cfg).
4. Open the required Configuration Profile.
5. Click **Restart...** to load the saved Configuration Profile.

5.4 Audio Settings

This section provides information about the following:

- [Various Tab](#)
- [Channels Tab](#)
- [Manual Audio Configuration](#)

5.4.1 Various Tab

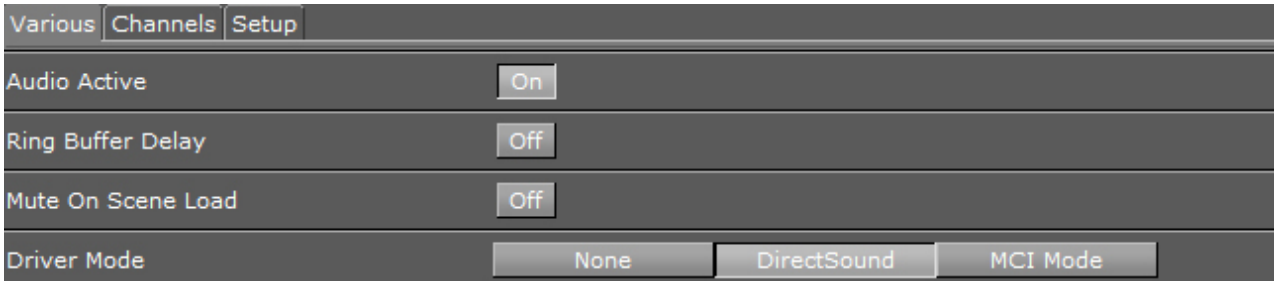

- **Audio Active:** This acts as a global on/off switch for audio in the Viz Engine.
- **Ring Buffer Delay:** Enable to make the audio system compensate for the ring buffer delay during clip playout. Ring buffer is ignored when disabled.
- **Mute On Scene Load:** When set to On, audio is muted before any scene load commands are executed. This is necessary for video cards which do not mute the audio automatically, when no video refresh happens.

.....
Note: Additional commands to mute audio can be added in the Viz Config file.

- **Driver Mode:** Affects playback of sound on the computer running Viz Engine, for audio monitoring purposes.
 - **None:** Prohibits Viz Engine from playing out sound on the local system.
 - **DirectSound:** Use DirectSound drivers (requires DirectX). This is the recommended driver.
 - **MCI Mode:** Use MCI driver mode, for systems where DirectSound is either not available or performs unsatisfactorily.

5.4.2 Channels Tab

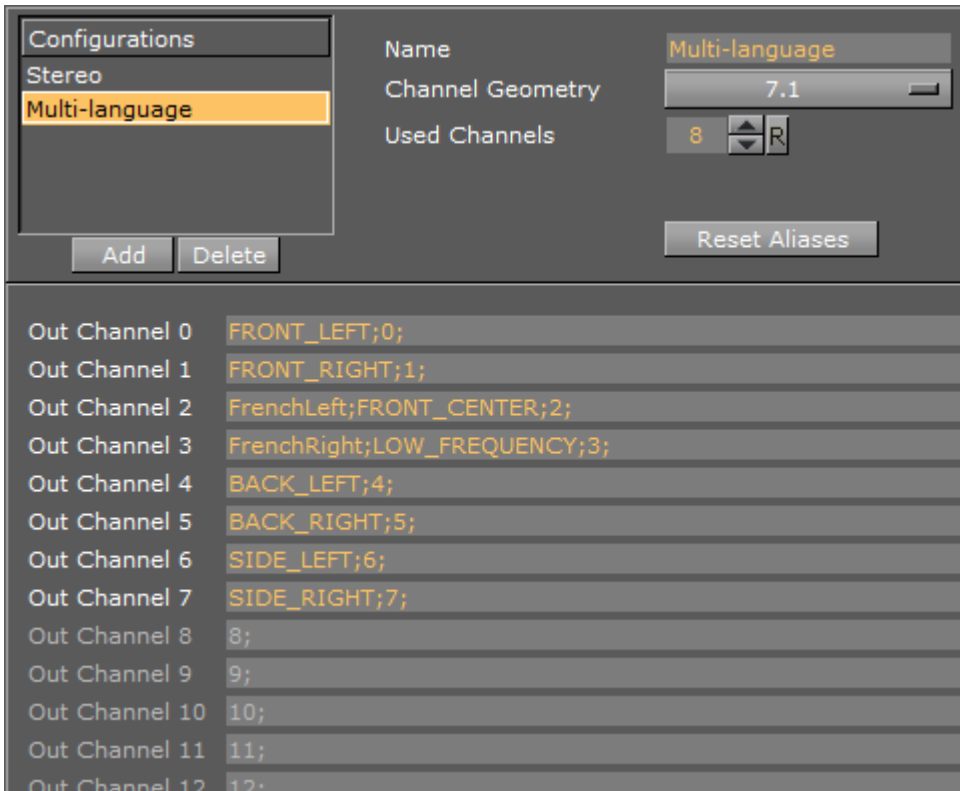

- **Configurations:** Shows a list of channel configurations.
- **Add:** Adds a new channel configuration to the Configurations list.
- **Delete:** Deletes the selected channel configuration from the Configurations list.
- **Name:** Set the name of the selected channel configuration.
- **Channel Geometry:** Sets the channel geometry. Options are:
 - Mono
 - Stereo
 - 5.1
 - 7.1
 - Quad
- **Used Channels:** Set the number of configurable channel alias fields that can be mixed by the internal channels in Viz Engine (software). On a Matrox system this number must be equal to the number of configured input channels (hardware). This setting is independent of the Channel Geometry setting.
- **Reset Aliases:** Set the channel aliases to the default option (the custom entry is not removed)
- **Out Channel 0-15:** The Out Channels represent the internal Viz audio channels, which are mixed to the output device one by one. Alias names are useful to create multilingual systems, and also to define the channel geometry for the Default and FX audio clip mix modes. Aliases are separated by a semicolon. The **Audio** plug-in only uses the channel aliases to find the correct speakers for Pan and 3D sound effects in FX mode. With this functionality any of the 16 internal audio channels can be used to play any audio geometry.

To Add Multi-language Audio Channels

1. From the Channels tab, click **Add**.
2. Select the new entry from the **Configurations** list
3. Enter the new name in the **Name** field.
4. Set the Channel Geometry to **Stereo**.
5. Click **Reset Aliases**.
6. Set the number of **Used Channels** to 4.
 - This will improve the performance.
7. In the **Channel 2** field, add the alias **FrenchLeft**.
8. In the **Channel 3** field, add the alias **FrenchRight**.
 - Add the same configuration for English (EnglishLeft, EnglishRight) and German (GermanLeft, GermanRight) on the other machines.
9. Click **Save**.

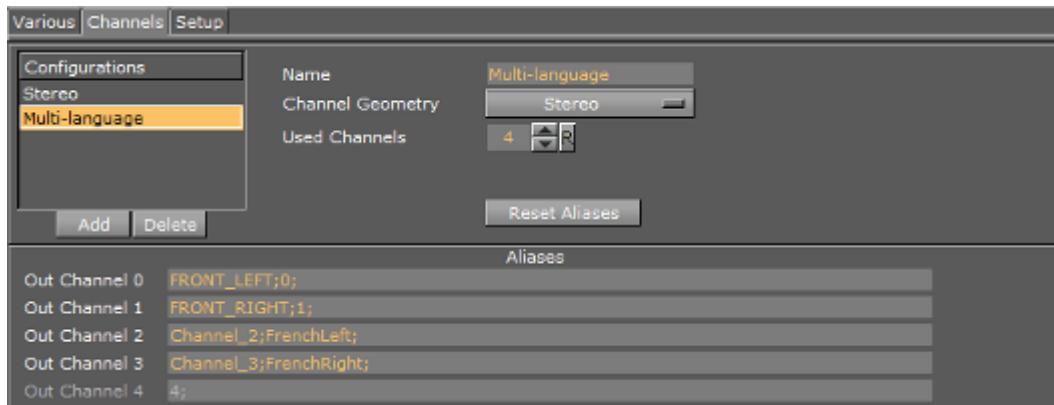

To Add Multiple Audio Channel Configurations

1. Repeat [To Add Multi-language Audio Channels](#) to add three more Multi-language Audio Channels.
Name the configurations the following way:
 - **Multi-languageF**
 - **Multi-languageE**
 - **Multi-languageG**
2. Add a **Multi-languageAll** configuration.
3. In the **Channel 1** field, add the aliases **FrenchLeft**, **EnglishLeft** and **GermanLeft**, then do the same for **Channel 2**.

```
FRONT_LEFT;  
Channel_0;FrenchLeft;EnglishLeft;GermanLeft;  
FRONT_RIGHT;  
Channel_0;FrenchRight;EnglishRight;GermanRight;
```

4. Click **Save**.

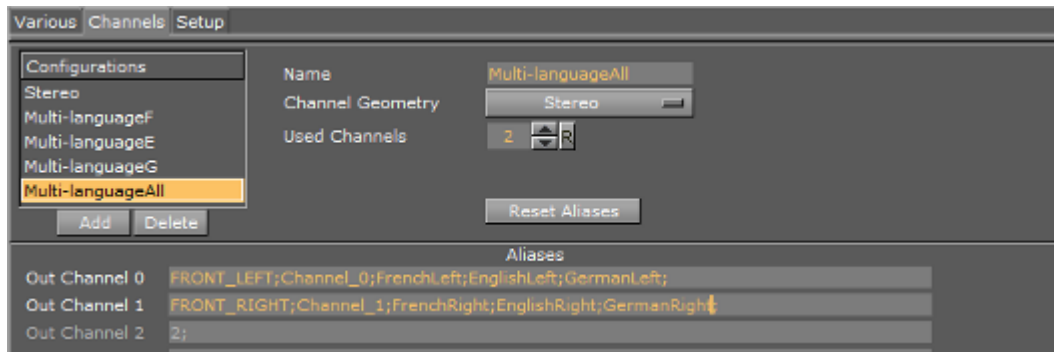

Setup Tab

The Setup tab lists all available audio devices available to the Viz Engine audio mixer (see [Audio in Viz](#)).

All devices listed with **Device0** are DirectSound compatible devices installed on the system. **Device0** is always the default playback device, configurable through **Sound** options in the Windows system **Control Panel**.

When a Matrox card is installed, Matrox audio is available.

With Matrox audio, there are different ways to capture audio for use with the Viz Engine audio mixer, before it is output:

1. Capture audio embedded in the live video input signal from the live input connectors.
2. Capture audio from the AES connectors.

The final output is the same, either embedded as part of the live video output signal, or separated out to the AES output connectors.

In addition, simply loop audio through the system. This will make the embedded or AES audio unavailable to the Viz Engine audio mixer.

The **Default** mode captures audio and directs it to the default onboard audio device with no output on the Matrox card output connectors.

.....
Note: The Matrox audio-extension board is not configurable through this user interface.

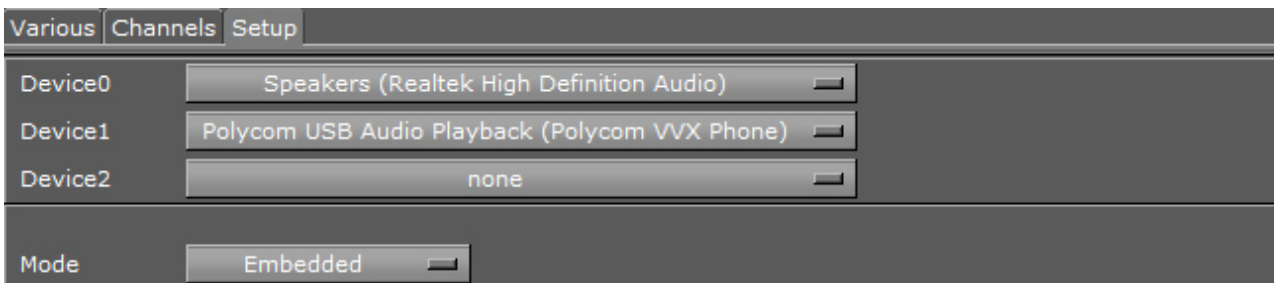

- **Device n:** Shows the name of the audio card.
- **Mode:** Refers to the audio mode of the Matrox board. Options are:

- **Embedded:** Audio is captured from the Live video input connectors and made available to the Viz Engine audio mixer, to mix it with other audio sources. Then output as embedded audio on the live video output connectors.
- **AES:** Audio is captured from the AES input connectors and made available to the Viz Engine audio mixer, to mix it with other audio sources. Then output on the AES output connectors.
- **Embedded -> AES:** Embedded audio is captured from the live video input connectors and made available to the Viz Engine audio mixer, to mix it with other audio sources. Then output on the AES output connectors.
- **AES -> Embedded:** Audio is captured from the AES input connectors and made available to the Viz Engine audio mixer, to mix it with other audio sources. Then output as embedded audio on the live video output connectors.
- **Loop:** Audio is looped through. No audio is mixed.
- **Default:** Audio is captured, but no output on the Matrox card.

5.4.3 Manual Audio Configuration

Certain use-cases require manual configuration of audio. Make sure to create a backup of the Viz configuration file before performing the following procedures:

To Map Audio Output for a Dual Channel Setup

1. In a Dual Channel environment there are two Config files, one for each Viz Engine.
2. For the first Viz Engine (1) the configuration of the audio output channel mappings should look like this:

```
Matrox0.AudioOut1.MapToVizChannel = 0
Matrox0.AudioOut2.MapToVizChannel = -1
```

3. Note that the audio output for the first Viz Engine (1) should be according to the video output channel:

```
Matrox0.VideoOut1.MapToVizChannel = 0
Matrox0.VideoOut2.MapToVizChannel = -1
```

4. For the second Viz Engine (2) the configuration should look like this:

```
Matrox0.AudioOut1.MapToVizChannel = -1
Matrox0.AudioOut2.MapToVizChannel = 0
```

.....
Note: In a stereo setup, audio must be set to OFF in the second Viz Engine (2).

5. Mind the difference to the video output settings:

```
Matrox0.VideoOut1.MapToVizChannel = -1
Matrox0.VideoOut2.MapToVizChannel = 0
```

6. All other audio output channels should be set to off:

```
Matrox0.AudioOut3.MapToVizChannel = -1
Matrox0.AudioOut4.MapToVizChannel = -1
```

To Manually Activate an Audio Device

1. Open the Viz Config file.
2. Go to **SECTION AUDIO_CONFIG** and locate the **Available0** setting.
3. Activate the identified audio device (**Available0**) by adding its name to the **AudioDevice0** setting.
 - For multiple outputs, more than one device can be added as AudioDevice1, AudioDevice2 and so on.
4. Save the Viz Config file.

.....
Example: AudioDevice0= Realtek HD Audio output
.....

5.5 Authentication

The Authentication panel is for the authentication of one or more [Viz One](#) systems on Viz Artist. Enter the details of each Viz One system to connect to.

To save a new user, all three panels of the Authentication panel must be completed. If a Realm is not required, enter <empty> in the Realm panel. If only one or two panels are completed, the information will not be saved.

The screenshot displays the Authentication panel with three main sections: Host Info, Realm, and User Info. Each section has a list of entries and control buttons (Add, Change, Remove). The Host Info section shows 'vme56-sia'. The Realm section shows '*'. The User Info section shows 'dco'. Below the sections, there are input fields for Host Info (vme56-sia), Realm (*), User (dco), Password (*****), and Confirm PW.

- **Host Info:** The host name of the Viz One server.
- **Realm:** Determines if an entry should be used in an authentication process for a given URI.
- **User Info:** Name and password for each User, for the selected Host and Realm.

See Also

- [Viz One](#) Configuration panel

5.5.1 Authentication Properties

This section contains information on the following topics:

- [Host Info Properties](#)
 - [Realm Properties](#)
 - [User Info Properties](#)

5.5.2 Host Info Properties

The host name of the Viz One server (see also [Fsmon \(File System Monitor\)](#)).

The host info is in the form 'host:port', where the colon and port number are optional. An asterisk value, '*', shows that it will be used against all hosts. The host info can be the Viz One host name or IP address.

Examples:

- Host Info = myhost.mycompany.com:8080
- Host Info = 10.0.1.2:8080
- Host Info = *

-
- A Host cannot be added without at least one Realm (or an empty Realm with <empty> entered) and one User defined
 - A Host can have more than one Realm

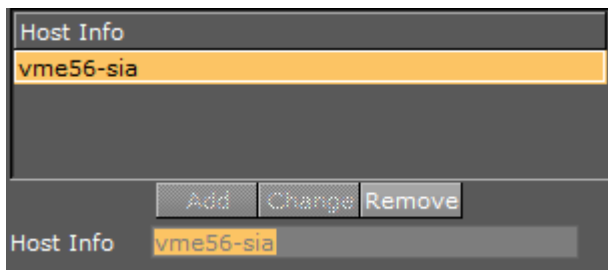

- **Add:** Add a host name.
- **Change:** Change a selected host name.
- **Remove:** Remove a selected host name.
- **Host Info:** Enter the name of the required Viz One host.

Note: Do not enter a URL as the Host Info name. The Host Info name format must be host [: port], for example: vizione.mycompany.com:8080.

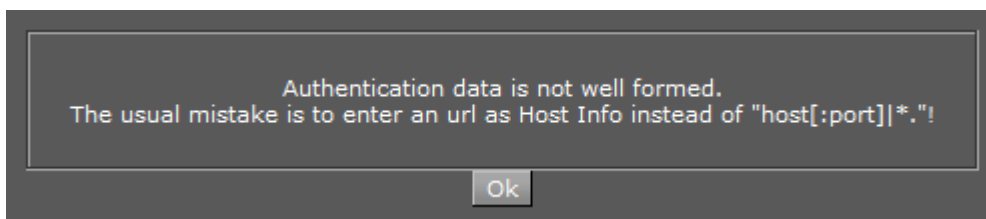

Realm Properties

Determines if an entry should be used in an authentication process for a given URI.

Example: A single value of shows that it should be used against all realms, i.e., Realm = [a-zA-Z_0-9] or '*'

- A Realm cannot be added to a Host without at least one User defined
- A Realm can have more than one User.

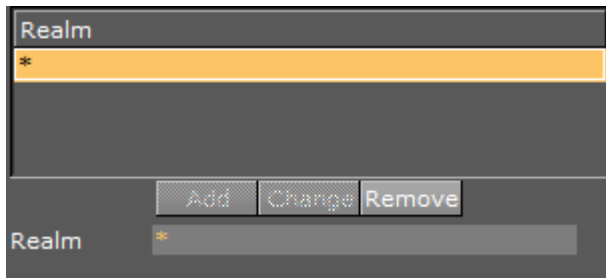

- **Add:** Add a Realm.
- **Change:** Change a selected Realm.
- **Remove:** Remove a selected Realm.
- **Realm:** Enter the name of the required Realm.

User Info Properties

Name and password for each user, for the selected Host and Realm. Passwords are not mandatory.

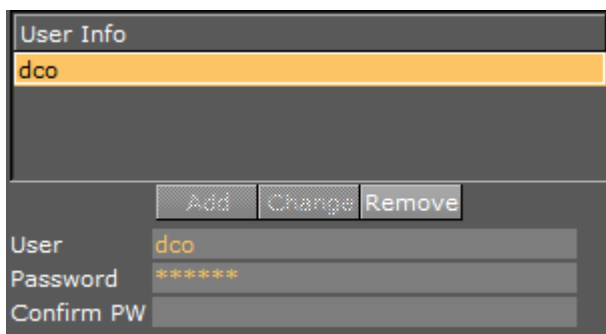

- **Add:** Add a user.
- **Change:** Change a selected user.
- **Remove:** Remove a selected user.
- **User:** Enter the user name.
- **Password:** Enter a password for the user, if required.
- **Confirm PW:** Confirm the user password.
- [Host Info Properties](#)
 - [Realm Properties](#)
 - [User Info Properties](#)

5.5.3 Authentication Panel Procedures

This section contains information on the following procedures:

- [To Add a Viz One Host](#)
- [To Add a Realm](#)
- [To Add a User](#)
- [To Change a Host, Realm or User Name](#)

- [To Delete a Host, Realm or User Name](#)

Do not enter a URL as the **Host Info** name. The Host Info name format must be host[:port]. For example: www.mycompany.com:8080.

Only entries which consist of Host + Realm + User will be saved to the configuration file. After the completion of the required procedures, make sure that you restart Viz Artist. Changes are not saved until Viz Artist has been restarted.

To Add a Viz One Host

To add a Viz One Host, a Realm and a User must also be defined.

1. Enter a Viz One Host name.
2. Click **Add**.



3. Enter a Realm name. If no Realm is required, enter <empty>.
4. Click **Add**.



5. Enter the new User name.
6. Enter and confirm the password, as required.
7. Click **Add**.

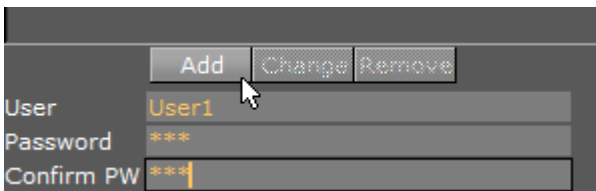

8. Click **Save** or **Save as...**



To Add a Realm

1. Click on a Viz One Host.
2. Enter a Realm name.
3. Click **Add**.

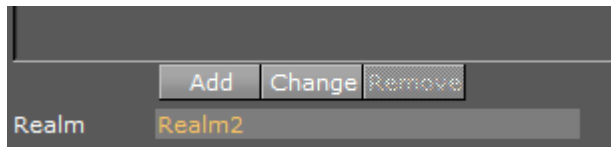

4. Enter a User name.
5. Enter and confirm the password, if required.
6. Click **Add**.

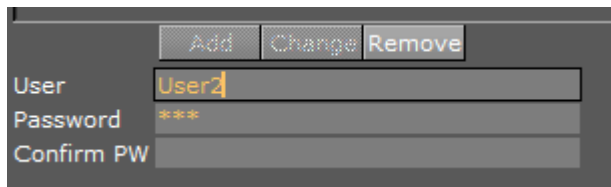

7. Click **Save** or **Save as...**



To Add a User

1. Select a Viz One Host.
2. Select a Realm.
3. Enter a User name.
4. Enter and confirm a User password, if required.
5. Click **Add**.
6. Click **Save** or **Save as...**

.....
Note: The password of the currently highlighted User will always show in the **Password** box.

To Change a Host, Realm or User Name

1. Click in the name field for either the:
 - Host Info
 - Realm
 - User
1. Make a change to the name as required.
2. Click **Change**.
3. Click **Save** or **Save as...**

To Delete a Host, Realm or User Name

If a Host is removed, any defined Realms or Users for that Host will also be removed. If a Realm is removed, all Users for that Realm will also be removed. When the last User is deleted then the related realm is deleted as well.

1. Make sure that the item to be deleted is highlighted (1).

2. Click **Remove** (2) for either the:

- Host Info
- Realm
- User

1. Click **Change**.
2. Click **Save** or **Save as...**

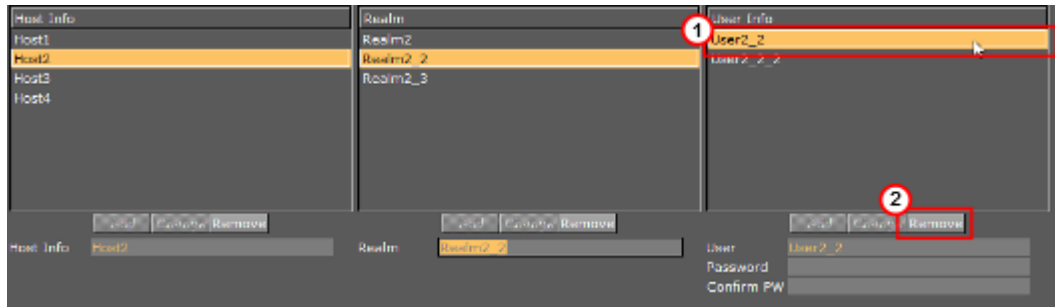

5.6 Camera

In the Camera section, special camera behavior settings which are used for virtual studio setups, can be set. Viz IO is used as the studio configuration and calibration tool for enabling connectivity and control between all required studio devices such as cameras, routers, VTRs, video servers, audio mixers and other studio equipment.

5.6.1 Camera Properties

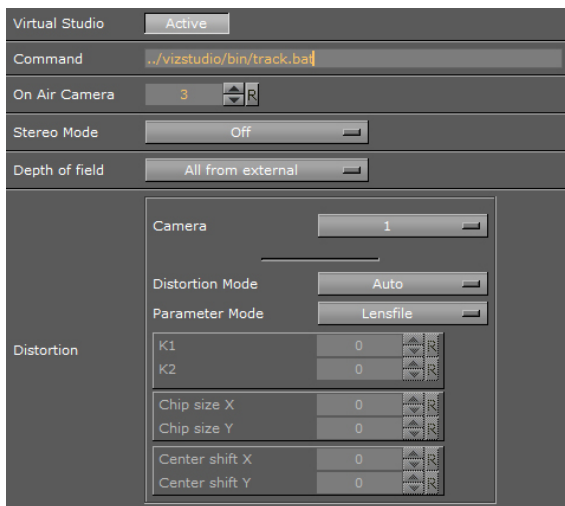

- **Virtual Studio:** When set to **Active** the tracking process will be started when Viz Engine is started
- **Command:** Set the path to the '.bat' file that will start the tracking process. If a valid path is given, Viz Engine will start Viz IO during startup.
- **On Air Camera:** Activates the selected camera that should be used when setting the scene in **On Air** mode. The camera is controlled by an external tracking device.
- **Stereo Mode:** (license required):

.....
Note: Stereo Mode settings only take effect when the design is taken on air.

- **Off:** Stereo mode is not available and can not be seen in the **GUI Camera Editor**
- **Quad Buffered:** When using nVisio glasses together with a monitor with a frequency >100Hz the image for the left/right eye will be shown alternately and the glasses will darken the other eye. This configuration provides the full resolution
- **Over Under Left Top/Over Under Right Top:** Both images will be drawn beneath each. Either side can be drawn first. The image height will be halved, providing half resolution
- **Left Eye/Right Eye:** Either the left or the right eye image will be rendered for dual-channel setups in combination with a Video Wall / Stereo Distributor. Full resolution
- **Side By Side Left/Side By Side Right:** Both images will be rendered side by side, either left or right first. The image width will be halved, providing half resolution
- **Depth of field:** Define from where parameters will be taken:
 - **Use editor:** parameters for depth of field are taken from the editor
 - **Focal plane from external:** only the focal plane is taken from the external camera
 - **All from external:** all parameters are taken from the external camera
- **Distortion:** Here you can set the lens distortion parameters for each camera individually.
 - **Camera:** set the camera number.
 - **Distortion mode:** set the preferred distortion depending on the tracking system which is used. Available distortion modes are:
 - **Auto**
 - **Internal**
 - **Libero**
 - **Xpecto**
 - **Radial**
 - **Stype**
 - **Trackmen**
 - **Parameter mode:** set the parameter for the lens distortion, depending on the tracking system which is used:
 - **Auto**
 - **Lens File**
 - **Libero**
 - **Manual**
 - **Tracking Hub**

See Also

- *Advanced Lens Distortion* in the Viz Artist User's Guide.

5.7 Communication

In this section, network connections can be set. External control software, for example, Viz Trio, uses TCP/IP network connections to send commands to the Viz Engine renderer engine (some external communications are also through UDP). Viz Artist expects the commands at the ports which are defined here.

The Communication panel has three tabs, Global, Shared Memory and VDCP (Video Disk Control Protocol).

5.7.1 Global Properties

Global	Shared Memory	VDCP
General Comm. Port	6200	
Additional Communication	None Udp Udp&Multicast	
Udp&Multicast Port Number	6100	
Multicast IP Address	224.1.1.1	
Enable GPI	Inactive	
MUX Isolated Port	50005	
MUX Shared Port	50008	
MUX Fixed Port	50009	
Still Preview Port	50010	
Multi Touch Input	Server UDP Mouse Win7 Touch TUIO Leap Win Stylus	
Multi Touch Port	0	
Multi Touch IP Address		
TUIO Port	3333	
Display Diagonal (inches)	27.0	
Display Aspect Ratio	1.778	
Frame Accurate Viz Comm.	Off	
FAVC Bias	0	
Command Field Dominance	Always Odd Retrace Counter Even Retrace Counter	
	Intern. Always / Extern. Odd Intern. Always / Extern. Even	
On Air Mouse Events	On	
REST Webservice	0 Install Uninstall	
Enable Logging	Inactive	
GFX Port	0	

- **General Comm. Port:** Set a general communication port for receiving external commands when in [On Air Mode](#). Make sure to update settings on the client side if you change the default port. The default is port 6100 (TCP).
- **Additional Communication:** Enables sending of commands to Viz Engine on **UDP** and **Multicast**, or a combination of the two. Video Wall setups use this.
- **Udp&Multicast Port Number:** Set the port number for the computers that share the same virtual IP address.
- **Multicast IP Address:** Set the shared virtual IP address.

.....
Note: The default maximum number of TCP connections is limited to 255. Within this number of connections, a user defined limit of maximum connections can be set.

Additional Communication	None	Udp	Udp&Multicast
Udp&Multicast Port Number	6100		
Multicast IP Address	224.1.1.1		

- **Enable GPI:** Enables initialization of supported Sealevel GPI/O devices when Viz Engine starts.
- **MUX Isolated Port:** Port number for isolated sessions - no shared data (NLE).
- **MUX Shared Port:** Port number for shared sessions - shared data (NLE).
- **MUX Fixed Port:** Port number for fixed sessions - shared data, no reference counting (NLE).
- **Still Preview Port:** Port number for still preview.

- **Multi Touch Input:**

- **Server UDP:** Multi Touch events are retrieved from the Viz Multi Touch Interface (see protocol documentation, Viz MultiTouchServer). An external server application connects to the touch device, translates the hardware messages into the Viz Multi Touch Protocol, and sends it via UDP to Viz Artist or Engine. This triggers the internal Multi Touch events in scripts utilizing the plug-in API.
- **Mouse:** Enable this to use a standard mouse to test Multi Touch trigger callbacks.
- **Win7 Touch:** Viz Artist and Engine uses Win7 Touch messages to generate Multi Touch events.
- **TUIO:** (Tangible User Interface Object) Select this if the touch device and/or application works with TUIO/OSC (Open Sound Control).
- **Leap:** Leap Motion is a hand and finger-tracking device. Activate this to receive multi-touch events from Leap.
- **Win Stylus:** Activates stylus pen input.
- **Multi Touch Port:** Port number where Viz Engine listens for the multi touch server. Required for Server UPD communication.
- **Multi Touch IP Address:** IP address where Viz Engine listens for the multi touch server. Viz Artist and Engine sends keep-alive messages to the Multi Touch Server. You need to enter the IP address of this server. Required for Server UPD communication.
- **TUIO Port:** Set the TUIO (Tangible User Interface Object) port number to communicate with a TUIO enabled multi-touch device. TUIO is a protocol for Table-Top Tangible User Interfaces. The default port for most TUIO applications is 3333.
- **Display Diagonal (inches):** Used for gesture recognition. Viz Artist and Engine can calculate transformations with momentum. For this, it needs to know the real, physical, screen-dimension to calculate the correct animation speeds. The value is in inches.
- **Display Aspect Ratio:** Used for gesture recognition. The real aspect ratio of the screen is required, as some screens do not have pixel aspect ratios of 1 . 0.

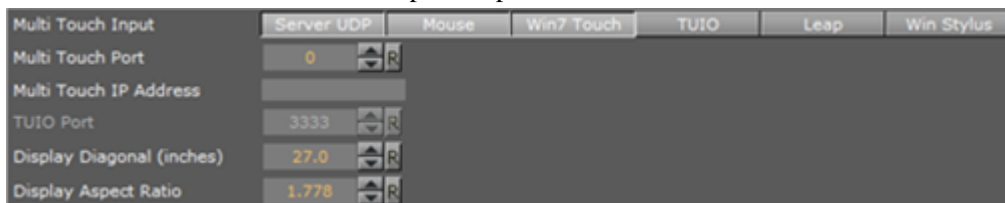

- **Frame Accurate Viz Comm.:** Frame accurate commands through TCP (commands delayed by ring buffer and specified FAVC bias). Enable only for external control that supports special frame accurate command execution. Used with [Frame Accurate Output](#).
- **FAVC Bias:** Define delay in fields, in addition to ring buffer size, for frame accurate commands via TCP or GPI. This is the bias in frames for the commands, if **Frame Accurate Viz Comm.** is set to On. Allows negative values.

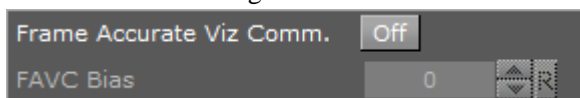

- **Command Field Dominance:** States when to handle the commands sent to Viz Engine. For example, when set to Odd Retrace Counter, Viz Engine handles all commands on odd fields. Not valid in progressive video output modes. Options are:

- **Always.**
- **Odd Retrace Counter:** Execute commands at an odd retrace counter.
- **Even Retrace Counter:** Execute commands at an even retrace counter.
- **Intern. Always/Extern. Odd:** Execute commands internally always and externally at an odd retrace counter.
- **Intern. Always/Extern. Even:** Execute commands internally always and externally at an even retrace counter.
- **On air Mouse Events:** Set mouse events in [On Air Mode](#) to On or Off.
- **REST Webservice:** Enter the port number for communication with the [Viz Engine REST interface](#). The default is 0, which deactivates the Webservice.

.....
Note: To view the current documentation for the REST interface, go to <http://localhost:<port number>/#/documentation>

- **Install:** Enter a port number and click **Install** to install the Webservice.
- **Uninstall:** Remove the Webservice.

.....
IMPORTANT! The Webservice does not automatically install when [User Account Control \(UAC\)](#) is active. Click **Install** to activate the Webservice.

- **Enable Logging:** Enable Webservice logging to the Viz Console.



- **GFX Port:** Set the GFX Channel starting port number (GFX2: GFX Port+1, GFX3: GFX Port+2). For example: 55000, 55001, 55002, etc.

5.7.2 Shared Memory Properties

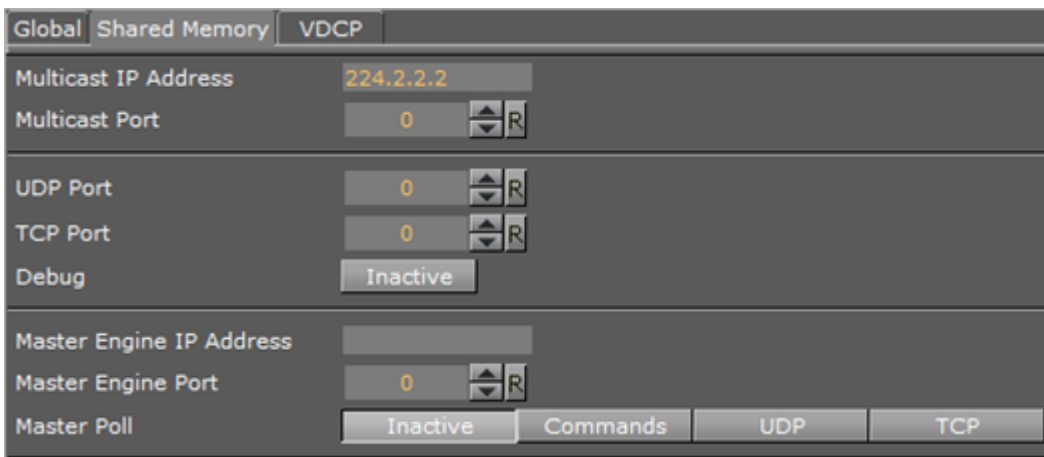

- **Multicast IP Address:** Set the address for synchronizing distributed shared memory map without a Graphic Hub.
- **Multicast Port:** Synchronize shared memory between all Viz Engines listening to the multicast.
- **UDP Port:** Set the UDP listening port for the shared memory input.
- **TCP Port:** Set the TCP listening port for the shared memory input.

- **Debug:** Enable Shared Memory logging for UDP and TCP communication.
- **Master Engine IP Address:** Set the IP address of the master Viz Engine which holds the complete shared memory map (loaded during startup of Viz Engine).
- **Master Engine Port:** Set the initializing port for the shared memory on startup (the command port of the master Viz Engine).
- **Master Poll:** Enable to make a Viz Engine load the shared memory map from the master Viz Engine, through the selected communication protocol. Available options are:
 - **Inactive**
 - **Commands**
 - **UDP**
 - **TCP**

See Also

- [Shared Memory \(SHM\)](#)
- **VizCommunication.Map** (see the [Viz Artist User Guide](#))

To Limit the Number of TCP Connections

Since Viz Engine 3.3, the number of TCP connections to Viz Artist can be set in the Viz configuration. The maximum number of TCP connections is limited to 255. If set to 1, the first control application connecting to Viz Artist/Engine will get exclusive control over Viz Artist/Engine.

1. Open the Viz Config file (for example: *Viz-<hostname>-0-0.cfg*).
2. Under **SECTION COMMUNICATION** set 'max_tcp_connections' to the number of TCP connections required.

This setting applies to the default port (6100) and the Multiplexing Ports.

5.7.3 VDCP Properties

The VDCP (Video Disk Control Protocol) tab enables the configuration of up to eight external controllers which can then have basic control over clip-channels and render-layers (Front, Main, Back).

	Enable	Protocol	Port	Mode	ID	Layer
Controller1	Inactive	TCP/IP	1	Clip Channel	1	Back
Controller2	Inactive	TCP/IP	1	Clip Channel	1	Back
Controller3	Inactive	TCP/IP	1	Clip Channel	1	Back
Controller4	Inactive	TCP/IP	1	Clip Channel	1	Back
Controller5	Inactive	TCP/IP	1	Clip Channel	1	Back
Controller6	Inactive	TCP/IP	1	Clip Channel	1	Back
Controller7	Inactive	TCP/IP	1	Clip Channel	1	Back
Controller8	Inactive	TCP/IP	1	Clip Channel	1	Back

Basic control is the ability to set a clip and to start, stop, pause or continue playback of a clip, or the scene animation in the specific layer.

- **Controller <1 to 8>**: Configure up to eight external controllers. Each Controller has these parameters:
 - **Enable**: Make the Controller connection Active or Inactive
 - **Protocol**: Select a protocol (TCP/IP or Serial connections) for the external control device
 - **Port**: Enter a port number. This port is where an external VDCP client can connect to the specified VDCP controller of the Viz Engine.
 - **Mode**: Select a mode:
 - **Clip Channel**: Enable the control of a selected video clip channel
 - **Layer**: Enable the control of animation in a layer
 - **ID**: Available if **Mode** is set to **Clip Channel**. Select a Clip channel (an ID (1 to 16)) to control
 - **Layer**: Available if **Mode** is set to **Layer**. Select either **Back, Main or Front**

5.8 Clock Formats

Format 1	hh:mm:ss	Format 11	
Format 2	h:mm:ss	Format 12	
Format 3	hh:mm	Format 13	
Format 4	h:mm	Format 14	
Format 5	hh:mm:ss.dd	Format 15	
Format 6	sss.dd	Format 16	
Format 7	ssss	Format 17	
Format 8	m:ss.dd	Format 18	
Format 9	dddd	Format 19	
Format 10	mm:ss	Format 20	

In this section, twenty various digital date and time formats can be set. Viz Engine distinguishes between uppercase and lowercase clock formats, allowing for even more customization options. Setting the clock format using lowercase letters forces Viz Engine to display the digit even if the value is 0. By defining the clock format using uppercase letters, Viz Engine will omit the value if it is zero. This allows the designer to omit unused digits while still planning for their use when designing the scene.

- **Format 1-20**: Sets and enables the clock formats that may be selected in Viz Artist during scene design.

.....
Tip: Add a font GEOM in Viz Artist to see how the clock formats can be used.

5.9 Database

The Database section has three tabs for setting connections to, e.g. a Graphic Hub, Failover servers and Deploy servers.

- [Global Properties](#)
- [Failover Properties](#)
- [Deploy Properties](#)

See Also

- [Graphic Hub User Guide](#)

5.9.1 Global Properties

In this section, the Graphic Hub database connection settings are configured.

Host Name	<input type="text" value="127.0.0.1"/>
Hub	<input type="text" value="VizDbServer"/>
Port Number	<input type="text" value="19396"/>
User	<input type="text" value="Guest"/>
Additional Host Names	<input type="text"/>
Communication Timeout Settings	
Failover Timeout (sec)	<input type="text" value="15"/> <input type="button" value="R"/>
Global RT Timeout (sec)	<input type="text" value="30"/> <input type="button" value="R"/>
Establishing Timeout (sec)	<input type="text" value="15"/> <input type="button" value="R"/>
Show Auto Log On	<input type="button" value="Yes"/>
Auto Log On	<input type="button" value="No"/>
Import by Name	<input type="button" value="No"/>
Popup Server Messages	<input type="button" value="Enabled"/> <small>'Disabled' works on localhost only!</small>
Date Format	<input type="button" value="EU"/> <input type="button" value="US"/>
Archive Bit-Mode	<input type="button" value="32 Bit"/> <input type="button" value="64 Bit"/> <small>Enable 32 Bit only if you want to ensure that archives created by this version of Viz Artist can be imported by 3.0.0 versions.</small>
Prefix Mode	<input type="button" value="No"/>
Prefix Converting Info	<input type="button" value="No"/>
Prefix Path	<input type="text"/>
Max Search Results	<input type="button" value="50"/> <input type="button" value="All"/> <small>It is recommended to use 'All' on small databases only!</small>
Search Date Mode	<input type="button" value="Modification"/> <input type="button" value="Creation"/>

- **Host Name:** Enter the name of the Graphic Hub naming service. The naming service will always be a one to one map to the Host Name of the machine running a Graphic Hub.
- **Hub:** Enter the Graphic Hub server name.
- **Port Number:** Enter the listener port number for a Graphic Hub. The default port number is 19396, and should normally not be changed.
- **User:** Set the default user.
- **Additional Host Names:** Enter the host name or IP address of a Graphic Hub database located on a different subnet, to make it selectable in the log on screen database drop-down list. Multiple entries can be added, and must be separated by a semicolon. Hosts located on different subnets will be highlighted in turquoise in the drop-down list.
- **Communication Timeout Settings:**
 - **Failover Timeout (sec):** Set the maximum time to wait before a fail over is initiated from the main to the replication Graphic Hub.
 - **Global RT Timeout (sec):** Set the maximum response time for any request to a Graphic Hub.

- **Establishing Timeout (sec):** Set the maximum waiting time to establish a connection to a Graphic Hub.
- **Show Auto Log On:**
 - **Yes:** Show the Auto log on check box in the Graphic Hub log on window.
 - **No:** The auto log on check box is hidden.
- **Auto Log On:** Enable or disable automatic log on to a Graphic Hub. This will disable the log on screen for Viz Artist/Engine.
- **Import by Name:** Set to **Yes** to check for objects by name rather than by UUID. Set to **No** to check by UUID.
- **Popup Server Messages:** Enable or disable popup server messages. Disabled only works on local host.
- **Date Format:** Set the date format to EU (DD.MM.YYYY 13:54) or US (MM/DD/YY 01:54).
- **Archive Bit-Mode:** Set the bit-mode in which the archive will be saved.

.....
Note: For compatibility, 32-bit should be enabled if scenes will be imported to Viz Artist versions prior to build 2310.

- The following prefix settings are needed if an external control application is used that sends commands containing certain path locations, but where the path of the files is a different one on the Graphic Hub (e.g. because they were deployed to a specific location).
 - **Prefix Mode:** Activate the prefix mode.
 - **Prefix Converting Info:** Show the prefixed (final) paths in the console (this behaves like the [Viz Artist 2.x](#) debug mode).
 - **Prefix Path:** Contains the prefix path string that is used for incoming commands containing path parameters.
- **Transfer Buffer Size:** The entered value is a multiplier for the standard buffer size of 51200 bytes and is only for the transfer buffer size to the Graphic Hub (Graphic Hub 2.4 and above only).
- **Max Search Results:** Set the maximum amount of search results which should show in the search result panel (see **Item Search** and **SmartViewSearch** in the [Viz Artist User Guide](#)).
 - **All:** Show all results. To set a maximum amount deactivate **All**

.....
IMPORTANT! If **All** is selected this could produce a large number of search results, which may affect the performance of Viz Artist. Vizrt recommend that **All** should be used on small databases only.

- **Search Date Mode:** Select the results date order for **Item Search** and **SmartView Search**:
 - **Modification:** Sort search results by their modification date
 - **Creation:** Sort search results by their creation date

5.9.2 Failover Properties

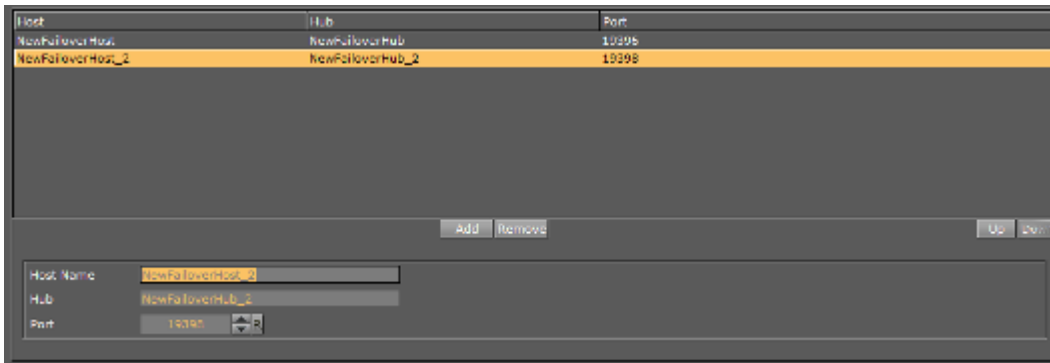

To Add Redundant Servers to the Failover List

1. Enter the **Host Name** of a Failover server.
2. Enter the Graphic **Hub** instance for Failover.
3. Enter the **Port** number of the Graphic Hub for Failover.
4. Click **Add**.
5. Use the **Up** and **Down** buttons in the database Failover list to raise and/or lower a database's priority in the event of Failover.
6. Click **Save**.

5.9.3 Deploy Properties

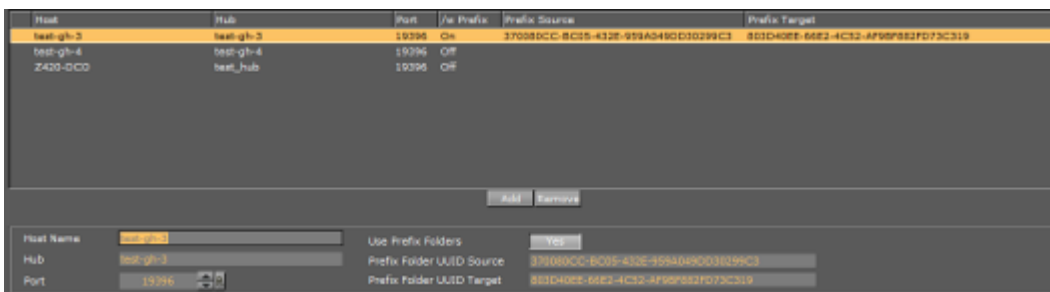

- **Added Deploy Servers Box:** View all available Deploy Servers
- **Add:** Add Deploy Servers (see [To Add Deploy Servers](#))
- **Remove:** Click to remove a selected Deploy Server
- **Host Name:** Enter the host name of the Graphic Hub machine to deploy files to
- **Hub:** Enter the name of the Graphic Hub instance to deploy files to.
- **Port:** Enter the Graphic Hub listener port number
- **Use Prefix Folders:** Set to **Yes** to select a source and destination folder for the deployment. Set to **No** to keep the structure the same as on the source server
 - **Prefix Folder UUID Source:** Enter the source folder UUID (Graphic Hub to deploy from)
 - **Prefix Folder UUID Target:** Enter the target folder UUID (Graphic Hub to deploy to)

.....
Note: The Source folder must be a child folder of the Target folder.

To Add Deploy Servers

Host	Hub	Port	Use Prefix	Prefix Source	Prefix Target
NewDeployHost	NewDeployHub	19396	On	99428109-579E-4614-B2CF6E2756302499	7DB2EFC6-ECC6-48B9-A619F1AEF8E13C45
NewDeployHost_2	NewDeployHub_2	19399	On		

Host Name	NewDeployHost
Hub	NewDeployHub
Port	19396

Use Prefix Folders	Yes
Prefix Folder UUID Source	99428109-579E-4614-B2CF6E2756302499
Prefix Folder UUID Target	7DB2EFC6-ECC6-48B9-A619F1AEF8E13C45

Host Name	NewDeployHost	Use Prefix Folders	Yes
Hub	NewDeployHub	Prefix Folder UUID Source	99428109-579E-4614-B2CF6E2756302499
Port	19396	Prefix Folder UUID Target	7DB2EFC6-ECC6-48B9-A619F1AEF8E13C45

Note: To configure deploy servers, the same User must also be logged in to the required source and deploy servers.

1. Enter the **Host Name** of a deploy server.
2. Enter the name of the deploy Graphic **Hub**.
3. Enter the **Port** number of the deploy Graphic Hub (default is 19396).
4. If specific source and destination folders are required, set **Use Prefix Folders** to **Yes**.
 - a. Enter the UUID of the **Prefix Folder UUID Source**
 - b. Enter the UUID of the **Prefix Folder UUID Target**
5. Click **Add**.
6. Click **Save**.

5.10 Font/Text Options

Default	Default			
Japanese Industry Standard Code	JIS			
Shifted Japan. Industry Standard	SJIS			
Extended Unix Code	EUC			
Unicode	Unicode			
UTF-8	UTF-8			
Default Text Orientation	Left	Center	Right	
Default Text V.-Orientation	Top	First Line	Center	Bottom
Default Text Direction	Left to Right	Right To Left	Top To Bottom	
Font Handling	Font file	Complex script		
Advanced import for Asian languages	Inactive			
Blur Import	Blur 1	Blur 2	Blur 3	Blur 4
Outline Import	Outline 1	Outline 2	Outline 3	
Calculate Max Bounding Box Size	Inactive			
Replace missing Characters with	0	(ASCII Value)		
Preserve newlines/spaces	Inactive			

In this section, the font encoding can be configured.

- **Font encoding. Available options are:**
 - **Default:** Sets the font encoding to single character interpretation (limited to 255).

- **Japanese Industry Standard Code (JIS):** Sets Japanese industry standard code character encoding.
- **Shifted Japanese Industry Standard Code (SJIS):** Sets the newer Shift JIS character encoding standard which sets aside certain character codes to signal the start of a two-character sequence.
- **Extended Unix Code (EUC):** Sets Extended Unix Code (EUC) character encoding that is a multi byte character encoding system used primarily for Japanese, Korean, and simplified Chinese.
- **Unicode:** Sets the Unicode character encoding where every two characters are inter-operated as one (not widely used).
- **UTF-8:** Sets UTF-8 (8-bit UCS/Unicode Transformation Format) character encoding that is a variable-length character encoding for Unicode.
- **Default Text Orientation:** Sets the default horizontal text orientation. Available options are; Left, Center and Right.
- **Default Text V. Orientation:** Sets the default vertical text orientation. Available options are; Top, First Line, Center and Bottom.
- **Default Text Direction:** Sets the default text direction. Available options are; Left to Right, Right to Left and Top to Bottom.
- **Font Handling:** Sets the font handling. Available options are Font file or Complex script.
 - **Font file:** Sets the font kerning to Font file that is mainly used for languages written from left to right.
 - **Complex script:** Sets the font kerning to Complex script. Complex script is mainly used for languages written from right to left, or when one character is composed of one or several Glyphs.

.....
IMPORTANT! With font handling in Complex Script mode, all fonts used must be installed in Windows to avoid unpredictable text behavior.

- **Advanced Import for Asian Languages:** Activate this option to import fonts to be used with special features, including vertical text and EUDC. This feature is useful for some Asian languages. The fonts must be installed in the operating system.
- **Font Import:** Sets the Font import. Available options are; File (Standard) and Windows (Advanced).
 - **File (Standard):** Imports and stores fonts on the database.
 - **Windows (Advanced):** Stores only the font name on the database. For this to work the font must be installed on the Windows system where Viz Engine resides.
- **Blur Import:** Enables blur levels for fonts used in Viz 2.x scenes. These options will make sure that fonts imported to Viz 3.x will be recreated with all blur levels used in Viz 2.x. Available options are Blur 1-4.
- **Outline Import:** Enables outline levels for fonts used in Viz 2.x scenes. These options will make sure that fonts imported to Viz 3.x will be recreated with all outline levels used in Viz 2.x. Available options are Outline 1-3.
- **Calculate Max Bounding Box Size:** Enables Viz Artist/Engine 3.x to calculate the bounding boxes as they were calculated in Viz Artist/Engine 2.x. In Viz Artist/Engine 3.x a text object's bounding box height will increase if a capital character is entered (e.g. an umlaut (double dots)). In Viz Artist/Engine 2.x the bounding box height was always the same and independent of the characters in the text object. Available options are Active and Inactive. Default is Inactive (false).

- **Replace missing Characters with:** Replaces a missing font character in a font file with a default font character. The Unicode value refers to the decimal value of the replacement character in the Unicode table (valid values are 0-65535). Normal usage would select a (42) or (95).
- **Preserve newlines/spaces:** When set to `Active`, spaces and newlines at the end of the text will not be removed when saving and reloading a scene. This influences bounding boxes. The default state is `Inactive`.

5.11 Global Input

The Global Input settings influence the generation and handling of Six Degrees of Freedom (6DoF) messages that can be distributed to several Viz Engines.

6DoF is used when working in 3D space in combination with special input devices such as a mouse. A mouse uses two coordinates (xy) which Viz Artist/Engine is able to translate into three coordinates (xyz) based on a grid.

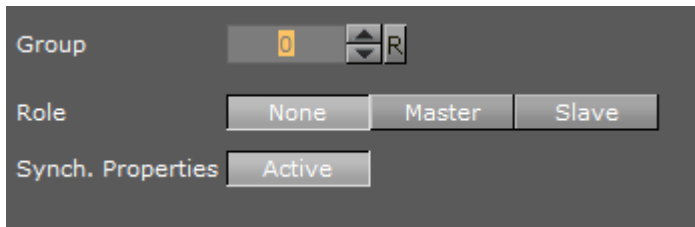

- **Group:** Define which multicast group the generated or received messages belong to. If more than one group is to be defined, a unique Group number must be set for each group
- **Role:** Defines how messages are generated and processed. Alternatives are; None, Master and Slave
 - **None:** Messages are only generated and processed on the local Viz Engine
 - **Master:** A Master creates messages for himself and the defined group
 - **Slave:** A Slave reads and processes 6DOF messages but is not allowed creating them
- **Synch. Properties:** Make the synchronization of Viz Engine Scene properties Active or Inactive

5.11.1 To Synchronize Multiple Viz Engines

1. Start Viz Config on all involved render machines.
2. Set the same Group ID for all Viz Engines
3. Set **Synch. Properties** to Active.
4. Save and close Viz Configuration on all machines.
5. Open the Control Panel on all render machines
6. Deactivate all unused network connections.
 - Viz Engine always uses the first network connection setup by the Windows operating system
 - Synchronized engines work within the same network segment only because it is using multicast, hence, it is important to use the right connection
 - The first connection can be determined by setting a manual metric in Windows: see <http://support.microsoft.com/kb/299540>
7. Start all Viz Engines again.
8. Create a simple test scene with a geometry and the Synchronized Properties plug-in (Built Ins > Container > Global) on the same container.

9. Save the Scene.
10. Open the Scene on all involved Viz Engines.
11. Move the geometry on one Viz Engine.
 - All the other Viz Engines will show the same object movement.

5.12 Import 3D Options

In this section, parameters which influence the import of 3D objects can be configured. There are three different formats:

- Wavefront
- AutoCAD
- 3D-Studio

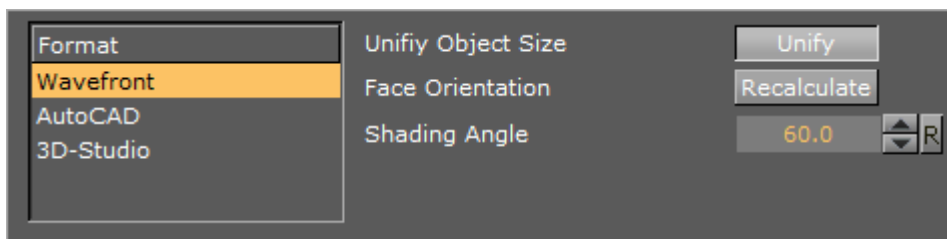

- **Unify Object Size:** If enabled, all vertices are recalculated during import in a way that the object center is moved to the origin (0,0,0), and the size of the object is 100 cm in its largest extent. If disabled, all vertices retain their values as defined in the original file. An object could appear invisible in a Viz Artist scene because the object is translated a lot from the origin or is scaled up or down a lot. It could be necessary to deactivate the unification to be able to recombine several separately imported objects that must keep their size and relative position.
- **Face Orientation:** Polygonal 3D models often do not have a consistent face orientation, but for performance reasons, the Viz Artist renderer expects that all faces of an object point to the same direction. If enabling this function, Viz Artist tries to rearrange the orientation of the object faces during import.
- **Shading Angle:** If the 3D object has no normal vector information, Viz Artist automatically recalculates the normals from the geometry to make lighting possible. This recalculation is influenced by the shading angle, which acts as a threshold between sharp and soft edges.

.....
Note: A shading angle value of 60 means that an edge between two faces is considered to be a soft edge for angles below 60 and a sharp edge above this level. 60 is the default shading angle.

5.13 Image File Name Convert

In this section, nine different replacement configurations can be set for image file names.

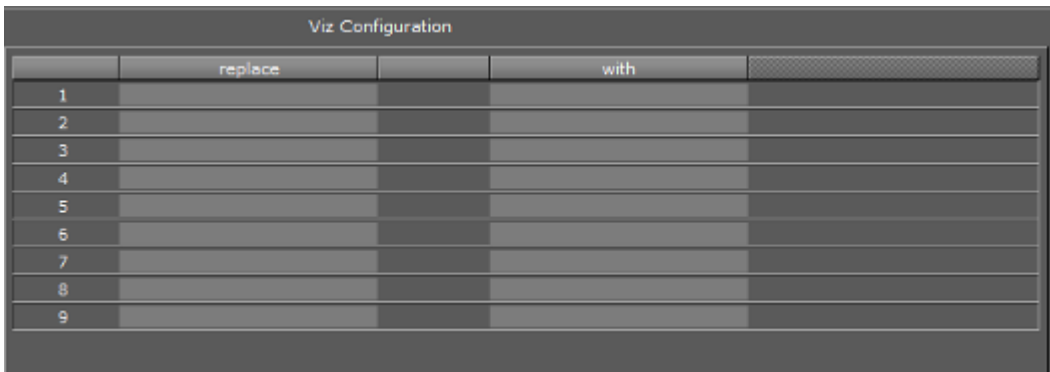

- **Replace:** Define the string to be replaced
- **With:** Define the replacement string

.....
Example: If an image file name starts with the string `Replace` this part of the file name can be replaced by the string `With`.

5.14 Local Settings

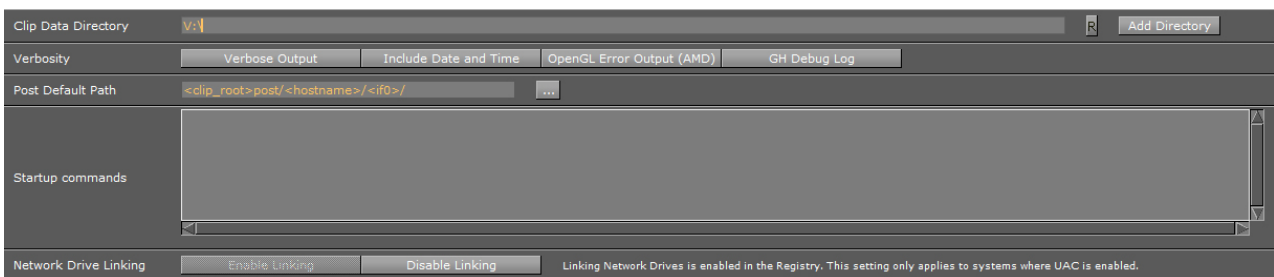

- **Clip Data Directory:** Set the clip directory (default directory is D:\ drive). Multiple directories can also be selected (see [Select Multiple Directories](#))

.....
Note: This directory is also used for Viz One installations, as the root parameter for the Fsmon and Mediaftp services (see [Viz One](#)).

- **Verbosity:** Select content of log files, if no selection is made only the default content of the log file will be created:
 - **Verbose Output:** Enables the most information in the Viz Engine Console.
 - **Include Date and Time:** Default content of the log file with the addition of date and time.
 - **OpenGL Error Output (AMD):** Default content of the log file with the addition of OpenGL Error Output (AMD).
 - **GH Debug Log:** Default content of the log file including Write GH Connection Log.
- **Post Default Path:** Set the default location of **Render to Disk** clips.
- **Network Drive Linking:** Enable to allow Viz Artist access to mapped network drives on certain systems where UAC is enabled.
- **Startup commands:** Enter and save commands that will be executed on startup, but after the initial setup configuration and before the main render loop activates. Examples:

```
FEEDBACK*CLIENT ADD localhost 2001
```

```
FEEDBACK*COMMAND ADD localhost 2001 CLIPOUT
RENDERER*MAIN_LAYER SET_OBJECT Vizrt_RD/mra/Reference/TC
/TC_DISPLAY
MAIN*DEBUG_CONTROL*RENDERINFO*PERFORMANCE SET 1
```

.....
Note: Log files will be written to the <viz_data_folder> directory, normally c:
\\ProgramData\\Vizrt\\viz3. This directory is by default hidden in Windows, so to navigate to this
directory in Windows Explorer specify the explicit path. For more information see [Viz Artist](#)
[/Engine Log Files](#).
.....

5.14.1 Select Multiple Directories

More than one clip directory can be selected.

When more than one directory path is selected in the **Clip Name** box, change the file path to <clip_root>. The included directories will be parsed when executing the search, returning video clips with file names matching the search criteria.

.....
Example: Search for a video clip named next_tuesday.avi in D:\\AEClips\\AFL\\Promos.
In the **Clip Name** box, change D:\\AEClips\\AFL\\Promos to <clip_root>. The filename
displayed in Viz Artist should be <clip_root>\\next_tuesday.avi.
.....

.....
Note: The directory has to match the directory set when the Mediaftp service for video transfer from
Viz One was installed.
.....

Multiple directories can be used with:

- Dual Channel and Trio Box CG configurations, or
- With any Viz Artist/Engine configuration for the selection of a secondary video clip directory if a directory fails.
If the file path for a video clip is set to <clip_root> and the first directory fails, the same video file will be searched for in the next directory in the Clip directory list.
If the **Clip Name** box is used to search for a video when multiple Clip directories are selected, the search will default to the last used directory.

See Also

- **Clip Properties** in the [Viz Artist User Guide](#)

5.15 Maps

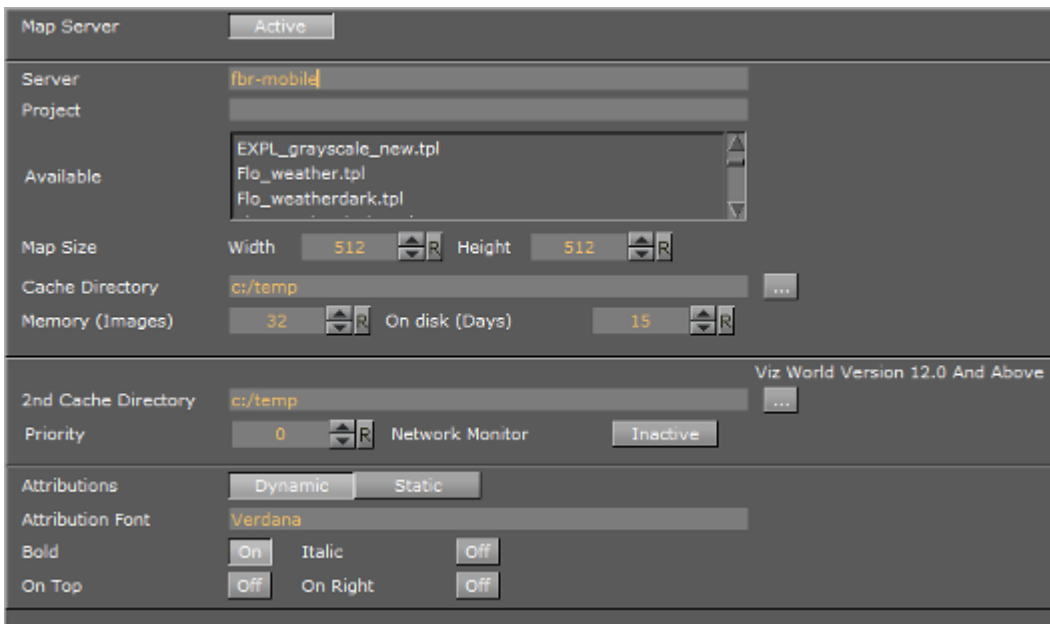

- **Map Server:** Enables or disables Viz World Server (WoS) connection for Viz World Client (WoC). If there is a problem with the Viz World installation, an error message will be displayed next to the Active/Inactive button.
- **Server:** Sets the Viz World Server host.
- **Project:** Sets the default map project that will be opened with the client application.
- **Available:** Lists all available Viz World Server projects.
- **Map size:** Sets the default map size that will be used with the client application.
- **Cache Directory:** Sets the cache directory for cached maps which can be a local drive, mapped drive or a Universal Naming Convention (UNC) path.

.....
IMPORTANT! Make sure the Cache Directory folder is configured with read and write access rights.
.....

- **Memory (Images):** Sets the number of images to keep in memory.
- **On disk (Days):** Sets the number of days to save images on disk.
- **2nd Cache Directory:** Enables a second cache (see Cache above). The main purpose of the second cache is to enable redundancy in those cases where a main cache directory is on a different computer and for some reason fails. Another use case is to use it as a local cache to save loading time in more complex operations. To shorten load time, copy large static files to the correct local cache folder. In the *3D Map Setting* plug-in, there is a **Sync Local Cache Folder** button which will copy all required files to the local cache. Note that the second cache directory settings can only be used by Viz World version 12.0 and later.
- **Priority:** Sets the machine's connection priority to the Viz World Server (Wos). Setting a number, where 1 is the lowest and 100 is the highest you may override connection priorities set by other machines. The configuration interface will allow you to prioritize client connections from Viz Artist and On Air Viz Engine's used for preview and program output. Viz Engines must be in On Air mode for them to be prioritized. For Viz World Map Editor you can set it from its context menu. To enable

this behavior on the server side you need to enable WoS to prioritize its connections/log ins. For more information, see the [Viz World User's Guide, Server Launcher Configuration](#) section. If the configuration option is not visible, [add the VizWorld.ini file](#) and set the priority.

- **Network Monitor:** Enables you to monitor relevant network connections (server and cache folders). If you do not monitor the network and you try to connect over a “disconnected network”, connecting to a server or a UNC path, it will take time before the system reports back (e.g. 30 seconds or more). Enabling network monitoring will avoid such connection issues. Note that the network monitor will only monitor a cache folder that use a UNC path (not mounted/mapped drives). If the configuration option is not visible you need [add the VizWorld.ini file](#).
- **Attributions:** Adds an attribution to the map. Alternatives are; Static and Dynamic.
 - **Dynamic:** Shows the attribution when a licensed imagery is in view and disappears when the image is out of view.
 - **Static:** Shows the attribution as long as there is a licensed imagery in the scene.
- **Attribution Font:** Sets the font for the attribution.
- **Bold:** Sets the attribution font to bold.
- **Italic:** Sets the attribution font to *italic*.
- **On Top:** Places the attribution image to the top in the screen. Default is bottom.
- **On Right:** Places the attribution image to the right in the screen. Default is left.

5.15.1 To Add the VizWorld.ini File

1. Create and save a VizWorld.ini file to the following location:

- `<viz install folder>\plugin\data\maps`

2. Open the file and enter the following:

```
Monitor=1 Priority=1 Language=[my Language ID]
```

3. Save the file and start, for example Viz Config, to see the configurable parameters.

Monitor enables network monitoring. For more information see the **Network Monitor** setting under the [Maps](#) section.

Priority sets Viz connection priority to the Viz World Server. For more information, see the [Viz World User's Guide](#).

my Language ID refers to the order of languages in your list of languages (e.g. English = 0, Arabic = 1, Hebrew = 2 and so on). For more information see the **Languages** setting under the [Maps](#) section.

5.16 Matrox

In the Matrox section assign Matrox Input and Output channels to Viz Engine Input and Output channels.

The GUI shows a drop down menu for the configurable parameters. The parameters available is dependent on the installed hardware.

- [General Properties](#)
- [VideoOut Properties](#)
 - [Map to Viz Channel](#)
 - [Fill Properties](#)

- [Key Properties](#)
- [Manager, Repeat and 3G Properties](#)
- [VBI Properties](#)
- [IP Properties](#)
- [VideoIn Properties](#)
 - [Map to Viz Channel](#)
 - [Allow Properties](#)
 - [Key Properties](#)
 - [Video Properties](#)
 - [VBI Properties](#)
 - [Audio Properties](#)

5.16.1 General Properties

The General properties panel shows information about the installed hardware.

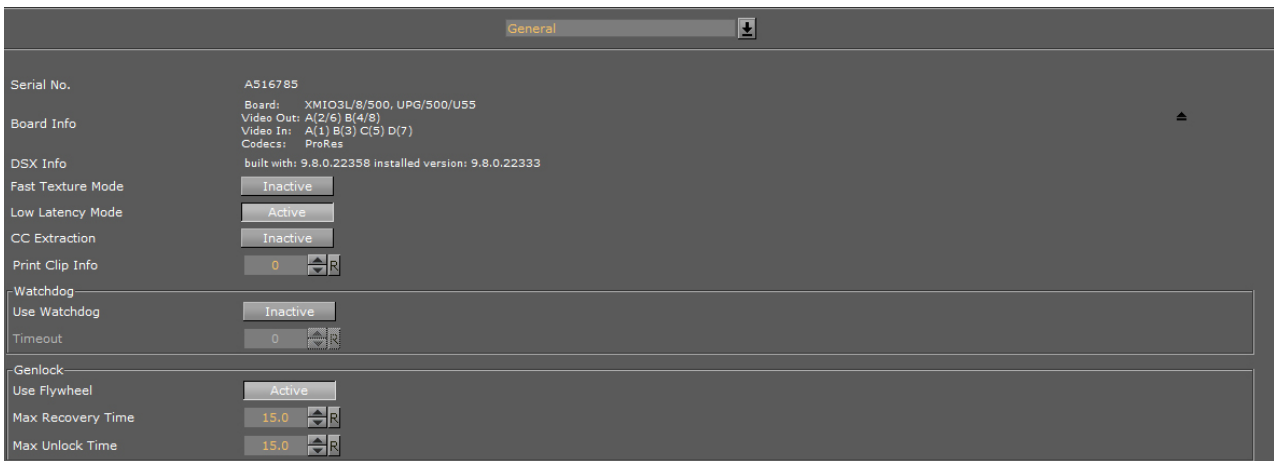

- **Serial No.:** Shows the serial number of the installed Matrox board.
- **Board Info:** Shows the model and type of the Matrox board.
- **DSX Info:** Shows the software version and driver version.
- **Fast Texture Mode:** Activate to shorten the 'in out' delay in Texture Mode to a minimum.

.....
Note: If **Fast Texture Mode** is set to Active, **DVE** will not work (see **Video Clip Payout Considerations** and **Video Payout** in the [Viz Artist User Guide](#)).

- **Low Latency Mode:** Enables Low Latency Mode required for Viz Opus with the Matrox X.mio3. Applies only to hardware configurations using the Matrox X.mio3 video board. Disabled by default.

.....
Note: Low Latency Mode is always enabled for configurations using the Matrox DSX LE 4 video board, and the setting cannot be changed for this card.

- **CC Extraction:** Enable or disable the closed captioning extraction for [Matrox X.mio3](#) and X.mio2+.
- **Print Clip Info:** When activated, this setting enables printing of clip information to the console. However, such information may cause the render loop to stall. Default mode is Inactive.
- **Watchdog:** A timer that allows a system to continue video pass-through during an application crash or system failure (see also [Watchdog \(Matrox X.mio Series\)](#) and [Video Board](#)):

- **Use Watchdog:** When set to **Active** enables the Matrox X.mio watchdog feature. It passes the input signal to the output when the Viz Engine is unresponsive. Default mode is **Inactive**. When set to **Active**, video out set to off, will activate the after a given timeout (see **Timeout**) (see also).
- **Timeout:** Set the time, in milliseconds, until the watchdog takes over control. This value should not be smaller than the time of two fields/frames. Default value is 999 milliseconds.

.....
Note:Use **Watchdog** and **Timeout** can also be set and changed in [Video Board](#).

- **Genlock:**
 - **Use Flywheel:** When activated, the Matrox board adopts a tracking mode if the genlock signal is interrupted or lost that maintains the signal frequency until the source genlock signal is regained. Default mode is Active.
 - **Max Recovery Time:** Represents the time in milliseconds (ms) provided to the flywheel to attempt to regain the genlock before an abrupt jump to the locked state is performed. Default value is 15.
 - **Max Unlock Time:** Represents the time in milliseconds (ms) provided to the flywheel to remain in the unlocked state before switching to the free running state. Default value is 15.

5.16.2 VideoOut Properties

In the VideoOut panel select which Viz Artist/Engine Output is mapped to the selected Matrox Output. The VideoOut panel shows the mapped Viz output channel and its editable parameters.

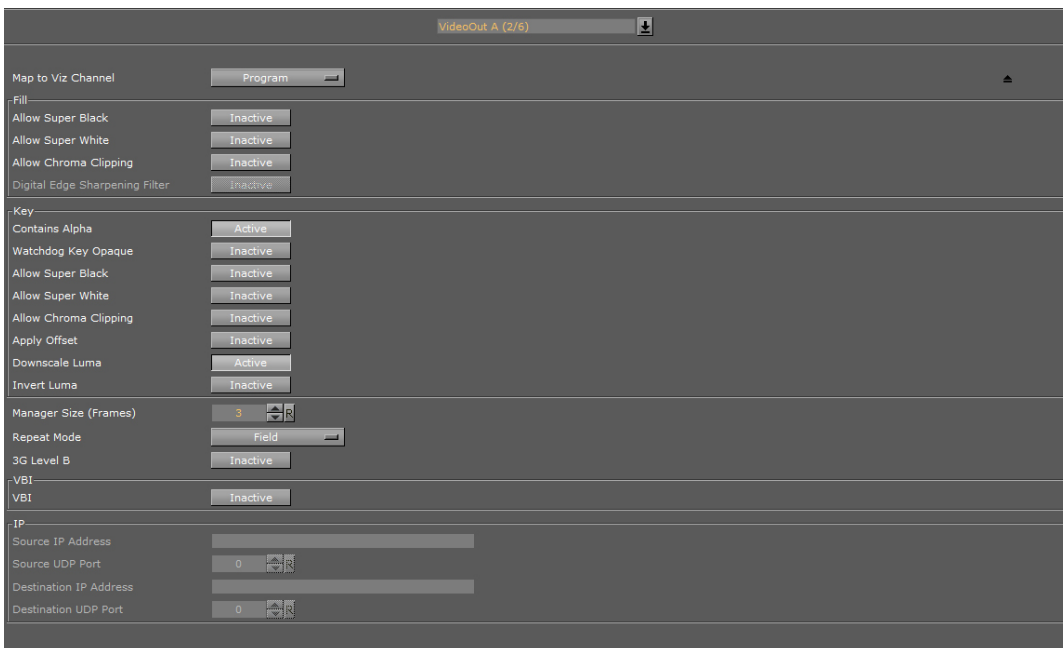

Map to Viz Channel

- **Map to VizChannel:** Select which video out channel is mapped to the selected Matrox video out channel. Select an Output channel from the drop-down menu. Only channels not already in use are shown. On single channel configurations, **VideoOut A** is usually mapped to **Program**, and **VideoOut B** to **Preview**. On Dual Channel configurations, the first channel maps **VideoOut A** to **Program**, and the second channel maps **VideoOut B** to **Program**.
 - **Unused:** Do not map this Matrox channel for output.
 - **Program:** Map the Program output to the selected video output of the Matrox card.
 - **Preview:** Map the Preview output to the selected video output of the Matrox card.
 - **Clean:** Output video without overlay graphics. Clean mode enables and activates a second output feed. This feed consists of DVE video content without any graphics and video textures: only live video, clip video, IP input, streaming input. This stream also includes a separate audio mix corresponding to the video only, excluding stage audio such as audio clips, plug-in audio, text-to-speech, etc., from the clean feed audio mix. If Watchdog functionality is required, **VideoOut A** must be mapped to **Clean**, and **VideoOut B** to **Program**. Requires Matrox X.mio3, X.mio3 IP, or DSX LE4.

Fill Properties

- **Allow Super Black:** Determines whether or not to clip an output video signal that is under 7.5 IRE units. Default mode is Inactive.
- **Allow Super White:** Determines whether or not to clip an output video signal that is over 100 IRE units. Default mode is Inactive.

The colorimetry tables for SD (ITUR-BT 601) and HD (ITUR-BT 709) define a color conversion from YUV with the range of 16-235 to RGB with the range of 0-255. Values above 235 are **Super White** and values below 16 are **Super Black**. As Super White and Super Black pixels are outside the range of 1-byte RGB, these pixels will be clamped to the normal 16-235 YUV range when used in a texture.
- **Allow Chroma Clipping:** Determines whether or not to clip over-saturated chroma levels in the active portion of the output video signal. Default mode is Inactive.
- **Digital Edge Sharpening Filter:** Applies an edge sharpening filter to digital output video. Default mode is Inactive. SD configurations only.

Key Properties

- **Watchdog Key Opaque:** Specifies if the output key must be opaque or transparent when the watchdog unit activates. Default mode is Inactive.
- **Allow Super Black:** Determines whether or not to clip an output video signal that is under 7.5 IRE units. Default mode is Inactive.
- **Allow Super White:** Determines whether or not to clip an output video signal that is over 100 IRE units. Default mode is Inactive.

Note: Please see the description about allowing **Super White** and **Super Black** in the **Fill Properties** section above.

- **Allow Chroma Clipping:** Determines whether or not to clip over-saturated chroma levels in the active portion of the output video signal. Default mode is Inactive.
- **Apply Offset:** Applies an offset to the luminance values such that the inverted result still falls within the 16-235 range. Default mode is Inactive.
- **Downscale Luma:** Compresses the luminance range of the output key signal from 0-255 to 16-235. Default mode is Active.
- **Invert Luma:** Inverts the luminance part of the output key signal (inverts the key). Default mode is Inactive.

Manager, Repeat and 3G Properties

- **Manager Size (frames):** Sets the number of frames available in the on-board memory for output. A too high value may cause memory problems on the Matrox board. Default value is 3.
- **Repeat Mode:** Defines the way the output should be repeated if Viz Engine is stalled and does not update the output. Default mode is Field. Available modes are:
 - **None:** Does not repeat. Output goes black.
 - **Field:** Repeats the last played field.
 - **Frame:** Repeats the last played frame.
- **3G Level B:** Activates Level B for 3G mode in 1080p 50/60/60M (default mode is Level A).

VBI Properties

Use this switch to enable or disable VBI (Vertical Blanking Interval) in the output:

- **Active:** Enable VBI output
- **Inactive:** Disable VBI output

IP Properties

These configuration settings are specific to the [Matrox X.mio3 IP](#) video board, and will be inactive if such a board is not installed.

- **Source IP Address:** Sets the IP address of the particular SFP being configured.
- **Source UDP Port:** Sets the UDP port of the particular SFP being configured.
- **Destination IP Address:** Sets the destination IP address. If sending to another Viz Engine with a [Matrox X.mio3 IP](#) board, or the other SFP on the local machine, this must be a multicast address in the IP Multicast address range, such as 224 . 10 . 10 . 31 or 239 . 10 . 10 . 51.
- **Destination UDP Port:** Sets the destination UDP port.

5.16.3 VideoIn Properties

The VideoIn tab shows the mapped Viz Artist channel and every setting of the input channel which can be controlled.

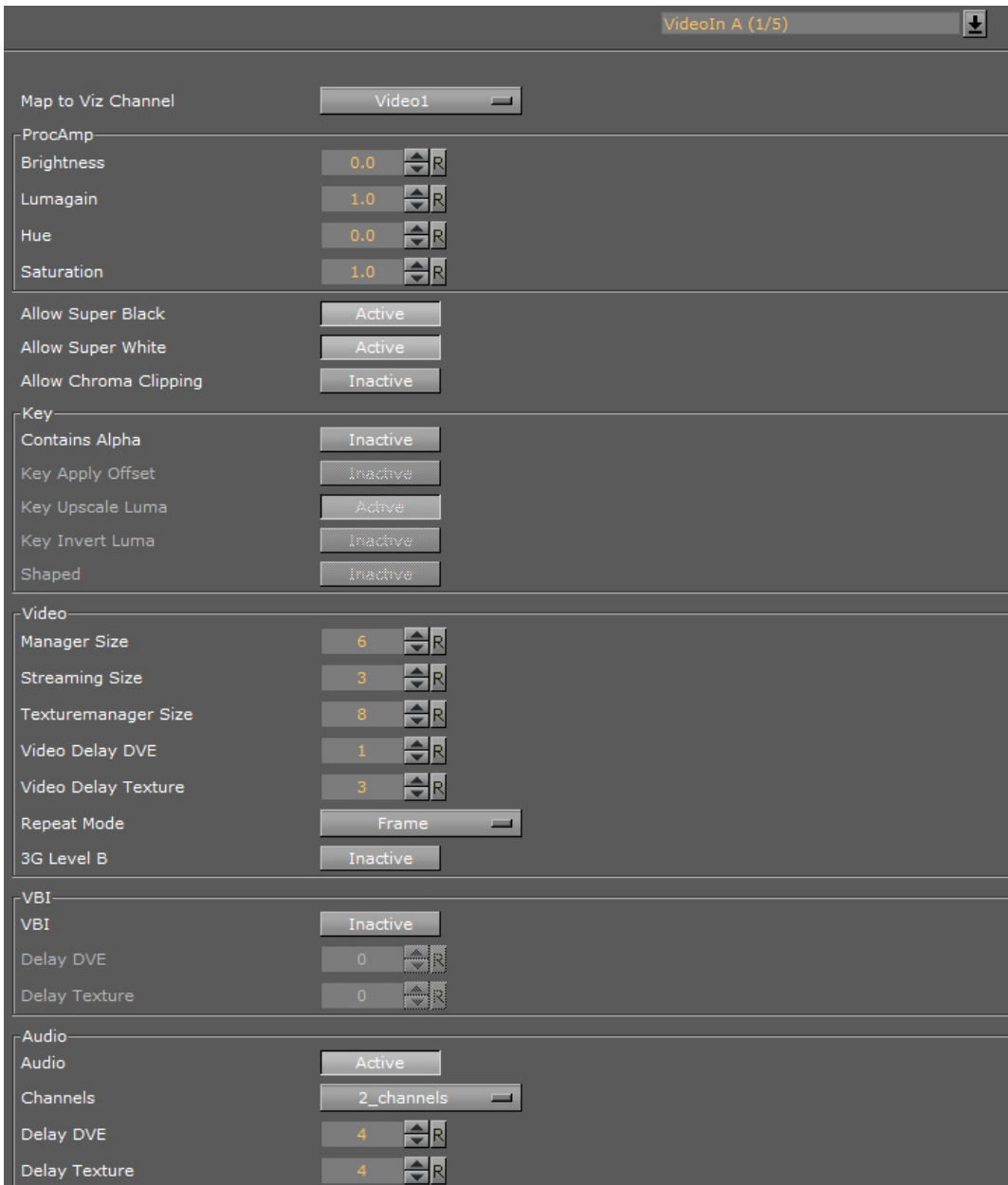

Map to Viz Channel

- Set which video in channel is mapped onto this Matrox video in channel. The drop-down gives a choice between the available channels. Only the channels not already taken are shown.
 - **Unused:** Do not use this Matrox channel for video input
 - **Video <1 to 8>:** Captured input is available in Video1.

.....
Note: On a single channel configuration **VideoIn A** is usually mapped to Video1 and **VideoIn B** to Video2 and so on whereas for a Dual Channel configuration usually the first channel maps **VideoIn A** to Video1 and the second channel maps **VideoIn B** to Video1. In this case both the first and the second channel have one video input configured, namely Video1.

Note: When running a machine with two graphics cards (i.e. a Dual Channel or Trio Box CG setup) video inputs are hardware resources on the Matrox board, that cannot be shared. If one input for both Viz Engine instances is required, split the signal and apply it to 2 video input connectors.

Allow Properties

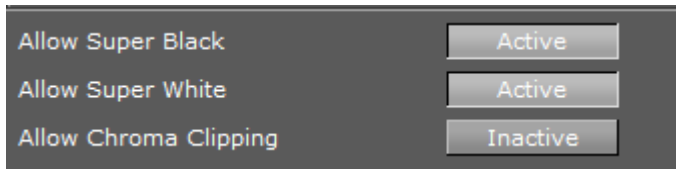

- **Allow Super Black:** Determines whether or not to clip an input video signal that is under 7.5 IRE units. Default mode is Active.
- **Allow Super White:** Determines whether or not to clip an input video signal that is over 100 IRE units. Default mode is Active.
- **Allow Chroma Clipping:** Determines whether or not to clip over-saturated chroma levels in the active portion of the input video signal. Default mode is Inactive.

Key Properties

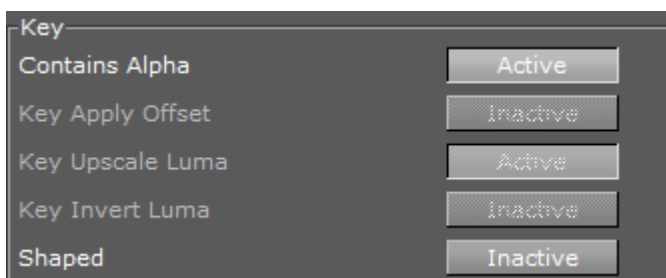

- **Contains Alpha:** Enables/Disables use of alpha component.

Note: This switch is only enabled on input channels where capture with alpha is supported.

- **Key Apply Offset:** Applies an offset to the luminance values so that the inverted result still falls within the 16-235 range.
- **Key Upscale Luma:** Expands the luminance range of the input key signal from 16-235 to 0-255.
- **Key Invert Luma:** Inverts the luminance part of the key signal (inverts the key).
- **Shaped:** Enables/Disables capture in shaped format.

Video Properties



- **Manager Size:** Sets the number of frames available in the on-board memory for capturing. This value is influenced by the input delays specified in the parameters below and will automatically be adjusted if it is too low. A too high value may cause memory problems on the Matrox board. Default value is 6.
- **Streaming Size:** Not in use.
- **Texturemanager Size:** Defines the size of the texture buffer in frames. Default value is 8.
- **Video Delay DVE:** Sets the number of frames the live input should be delayed before it can be used as a DVE layer. Default value is 0 (Off).
- **Video Delay Texture:** Sets the number of frames the live input should be delayed before it can be used as a texture in the scene (default value is 4 (this is the minimum value, the maximum value is 50)).

.....
Note: X.mio2 and DSX.LE3 minimum delay is 4, and the X.mio2 Plus minimum delay is 1. These values are for the hardware and cannot be decreased. If set to below the minimum value in the GUI the engine will reset to the minimum value.
.....

.....
Note: For certain input resolutions these minimum values are not sufficient and need to be increased. The the Viz Engine installation provides configuration templates for each video resolution.
.....

- **RP188 Enable:** Enables capturing of SMPTE RP 188 extra information such as LTC and VITC. Default is Inactive.
- **Repeat Mode:** Determines the behavior of the video input in case of capture drops. Options are:
 - **None:** Does not repeat. Input goes black.
 - **Field:** Repeats the last field.
 - **Frame:** Repeats the last frame.
- **3G Level B:** Activates Level B for 3G mode in 1080p 50/60/60M (default mode is Level A).

VBI Properties

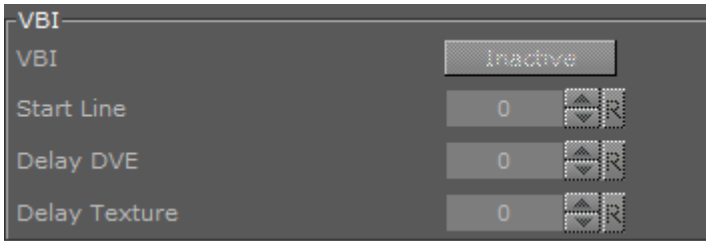

- **Enable:** When set to Active this setting will enable VBI for this channel. Default is Inactive.

.....
Note: If the input resolution is different from the output resolution it is impossible to activate since can only be inserted if the resolutions are the same.
.....

- **Start Line:** Defines at which line on the input the VBI section will start. Default value is 0 (Off). The minimum VBI values are (as for VideoOut):
 - **NTSC:** 7
 - **PAL:** 6
 - **720p:** 7
 - **1080i:** 6
- **Delay DVE:** Sets the number of frames the VBI should be delayed before the clip can be used in DVE mode (Default is 0 (Off)).
- **Delay Texture:** Sets the number of frames the VBI should be delayed before the clip can be used in texture mode. Default is 0 (Off).

Audio Properties

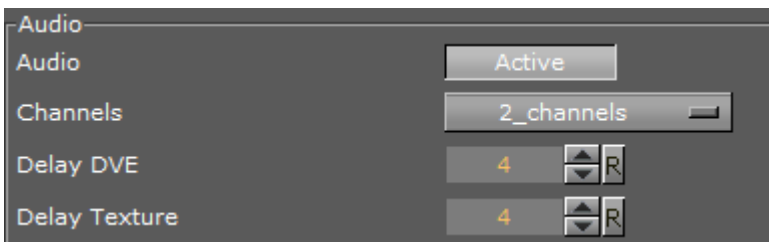

- **Audio:** When set to Active this setting enables audio capturing on this channel. Default mode is Active.
- **Channels:** Sets the number of audio channels to capture (see also [Audio in Viz](#)). Default number of channels are 2. Available channel options for AES on X.mio are:
 - None, 1, 2, and 4.
For AES on X.mio2/X.mio2 Plus and for Embedded the channel options are:
 - None, 1, 2, 4, 8, and 16.
- **Delay DVE:** Sets the number of frames the audio should be delayed in DVE mode before it can be mixed to the output. Default value is 4.
- **Delay Texture:** Sets the number of frames the audio should be delayed in texture mode before it can be mixed to the output. Default value is 4.

5.17 Memory Management

Free Image Data	<input type="radio"/> No <input checked="" type="radio"/> On-air <input type="radio"/> Always
Free Images	<input checked="" type="checkbox"/> On
Free Fonts	<input checked="" type="checkbox"/> On
Free Memory Threshold (MB)	0 <input type="button" value="▲"/> <input type="button" value="▼"/> <input type="button" value="R"/>
Delayed Object Cleanup (min)	0 <input type="button" value="▲"/> <input type="button" value="▼"/> <input type="button" value="R"/>
Preload Textures	<input type="checkbox"/> Off
Free Now	<input type="button" value="Scenes"/> <input type="button" value="Geometries"/> <input type="button" value="Images"/> <input type="button" value="Fonts"/> <input type="button" value="All"/>
Spawned Process Threshold	0 <input type="button" value="▲"/> <input type="button" value="▼"/> <input type="button" value="R"/>

Application memory management involves supplying the memory (main memory and graphic card memory) needed for a program's objects and data structures used for in-memory objects such as images, fonts and so on from the limited resources available. Memory management also recycles memory for reuse when required and appropriate.

.....
Note: Using the 64-bit version of Viz Engine on hardware that supports it with sufficient memory (>4GB RAM) can in many cases help performance and is generally recommended.
.....

In the Memory Management section of the configuration you can give detailed hints to the Viz Engine how memory should be handled:

- **Free Image Data:** When enabled (*On-Air* or *Always*), then image data is freed after texture creation.

.....
Note: If there are modifications done to an image, then its texture will be rebuilt a lot faster if the data already lies in the main memory (instead of re-loading it from the database).
.....

- **No:** Disables the Free Image Data option. This option is faster, but requires a lot of memory.
- **On-air:** Frees image data when in On Air mode, but not in Viz Artist mode.
- **Always:** Frees image data every time after the texture was created. This option saves a lot of memory but is slower in case of texture rebuilds.
- **Free Images:** When enabled (*On*), then unused images (i.e. not referenced in a loaded scene) are removed from the Image Pool (main memory and graphics card memory).
- **Free Fonts:** When enabled (*On*) removes unused fonts from the Font Pool.
- **Free Memory Threshold (MB):** If set to greater than zero (>0) then Viz Engine tries to automatically unload unused Pool objects until the specified amount of main memory is free again.

- **Delayed Object Cleanup (min):** Set the delay to clean up pool objects. Default: 0 minutes which effectively disables the delayed clean up. If set to a value greater than 0, objects do not immediately get deleted when unloaded from the renderer, and keeps objects in memory for subsequent use. While this improves performance for certain scenarios, it increases the memory footprint of Viz Engine.
- **Preload Textures:** When enabled (On), all images which are to be loaded with a Scene (they do not need to be rendered) are loaded as textures to the graphics card too. This eliminates the texture creation time during rendering afterwards (e.g. useful when initializing a show or a playlist). Default is disabled (Off).
- **Free Now: Frees the selected unused Pool objects (Scenes, Geometries, Images, Fonts or All)** from the memory.
- **Spawned Process Threshold:** Sets the maximum number of child processes spawned by Viz. If the number of child processes exceed the set value, a pool cleanup is automatically triggered. When set to 0, automatic cleanups are disabled. The default value is 0.

5.18 Multiview

The Multiview feature provides the possibility to show a preview of channels (including live and clips) and do the actual rendering of the program on the same system. The channel preview is shown in a separate window.

The *Viz Opus* system utilizes Multiview for preview, providing an efficient and cost-effective “TV in a Box” solution.

Two GPUs are required for this setup. One GPU is used for rendering and the other one to show the preview. This to make sure the Engine rendering is not affected by the preview window.

Multiview is disabled by default, but can be enabled by editing the Engine configuration file and changing the Multiview configuration setting to `set enable_media_preview = 1`. Follow these steps:

- Locate the Viz Engine configuration file, normally in `C:\ProgramData\vizrt\viz3`. For security, copy the configuration file to a backup location before making changes.
- Change the following entries as appropriate and make sure to save the configuration file as a text-file. The Viz Engine needs to be restarted for the changes to take effect.

```
## Enable multiview feature. Disabled by default.
enable_media_preview = 1
## Set the GPU on which Multiview should be executed. (one based)
media_preview_affinity_gpu = -1
## Set the update frequency for Multiview.
media_preview_update_freq = 1
```

Parameters:

- `enable_media_preview = 0` or `1` (1 = enabled, 0 = disabled)
- `media_preview_affinity_gpu = -1` (-1 for preview not enabled. If enabled: 1 = GPU1, 2 = GPU2 and so on)
- `media_preview_update_freq = 1` (Refresh rate. E.g. 1 means that one preview channel is updated every render cycle.)

See Also

- [Viz Opus information](#) (external link)

5.19 Path Aliases

In this section, up to five favorite archive and ten import paths can be set. These are accessible through Viz Artist's Archive and Import panes.

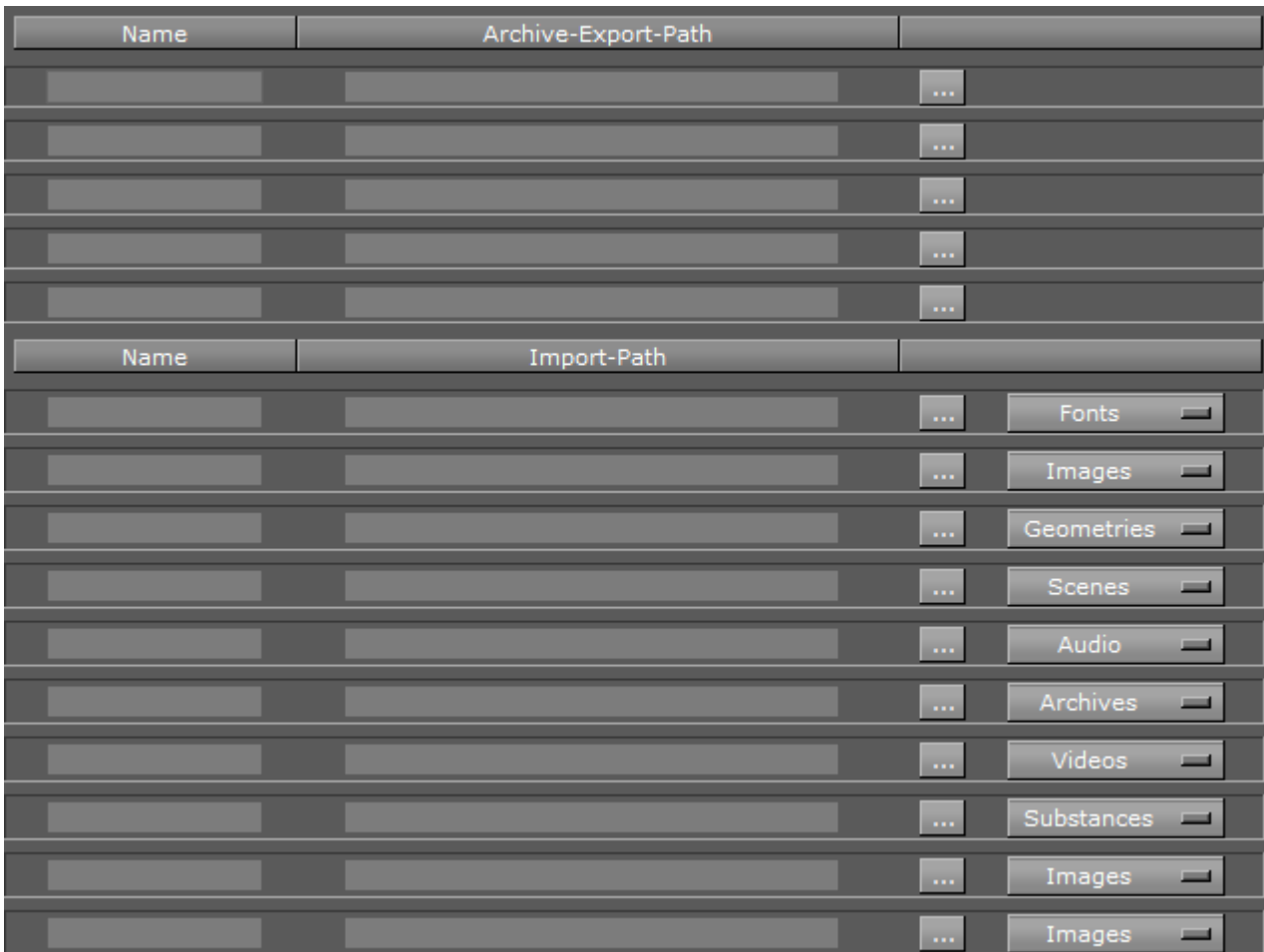

- **Name:** Sets the path alias name for the archive or import path.
- **Path:** Sets the archive or import path which can be a local drive, mapped drive or a Universal Naming Convention (UNC) path.

.....
IMPORTANT! Make sure the archive folder is configured with read and write access rights.
.....

5.19.1 To Add a Path

1. Enter a descriptive name in the **Name** field
2. Enter a path in the **path** field, or click the **Browse** button to navigate and select a path.
3. Assign a type. Options are:
 - Fonts

- Images
- Geometries
- Scenes
- Audio
- Archives
- Videos
- Substances

In this way, when clicking on an alias before a file is imported, the import window automatically opens the designated folder and switches to the assigned type.

4. Click **Save**.

Name	Import-Path		
Cone	C:\Program Files\vizrt\Viz3\import	...	Fonts
Arial	C:\Program Files\vizrt\Viz3\Documentation	...	Images
Hot	C:\Program Files\vizrt\Viz3\HotFolder	...	Geometries
		...	Scenes
		...	Audio
		...	Archives
		...	Videos
		...	Substances
		...	Images
		...	Images

5.20 Output Format

In this section, the output format of the rendering engine can be set. All video hardware configurations are hooked to the video standard set as output format. This setting defines the frequency (frame rate) at which Viz Engine is running.

Name	Specification	Resolution	Frequency	Aspect
NTSC	480I_5994_SMPTE259_NTSC	720 x 486	59.94 Hz	4:3
NTSC	480I_5994_SMPTE259_NTSC	720 x 486	59.94 Hz	16:9
PAL	576I_5000_SMPTE259_PAL	720 x 576	50.00 Hz	4:3
PAL	576I_5000_SMPTE259_PAL	720 x 576	50.00 Hz	16:9
720p HD Progressive	720P_5994_SMPTE296	1280 x 720	59.94 Hz	16:9
720p HD Progressive	720P_5994_SMPTE296	1280 x 720	59.94 Hz	16:9
720p HD Progressive	720P_6000_SMPTE296	1280 x 720	50.00 Hz	16:9
1080i HD Interlaced	1080I_5000_SMPTE274	1920 x 1080	50.00 Hz	16:9
1080i HD Interlaced	1080I_5994_SMPTE274	1920 x 1080	59.94 Hz	16:9
1080i HD Interlaced	1080I_6000_SMPTE274	1920 x 1080	50.00 Hz	16:9
1080p HD	1080P_5000_SMPTE424M	1920 x 1080	50.00 Hz	16:9
1080p HD	1080P_5994_SMPTE424M	1920 x 1080	59.94 Hz	16:9
1080p HD	1080P_6000_SMPTE424M	1920 x 1080	50.00 Hz	16:9
2160p UHDTV1	2160P_5000_SMPTE2036_UHDTV1	3840 x 2160	50.00 Hz	16:9
2160p UHDTV1	2160P_5994_SMPTE2036_UHDTV1	3840 x 2160	59.94 Hz	16:9
2160p UHDTV1	2160P_6000_SMPTE2036_UHDTV1	3840 x 2160	50.00 Hz	16:9
2160p 2SI UHDTV1	2160P_5000_SMPTE425_5_UHDTV1	3840 x 2160	50.00 Hz	16:9
2160p 2SI UHDTV1	2160P_5994_SMPTE425_5_UHDTV1	3840 x 2160	59.94 Hz	16:9
2160p 4K	2160P_5000_SMPTE2036_4K	3840 x 2160	50.00 Hz	16:9
2160p 4K	2160P_5994_SMPTE2036_4K	3840 x 2160	59.94 Hz	16:9
2160p 4K	2160P_6000_SMPTE2036_4K	3840 x 2160	50.00 Hz	16:9
Fullscreen	FULLSCREEN			
User Defined	USER_DEFINED			

Name	Specification
NTSC	480I_5994_SMPTE259_NTSC
NTSC	480I_5994_SMPTE259_NTSC
PAL	576I_5000_SMPTE259_PAL
PAL	576I_5000_SMPTE259_PAL
720p HD Progressive	720P_5000_SMPTE296
720p HD Progressive	720P_5994_SMPTE296
720p HD Progressive	720P_6000_SMPTE296
1080i HD Interlaced	1080I_5000_SMPTE274
1080i HD Interlaced	1080I_5994_SMPTE274
1080i HD Interlaced	1080I_6000_SMPTE274
1080p HD	1080P_5000_SMPTE424M
1080p HD	1080P_5994_SMPTE424M
1080p HD	1080P_6000_SMPTE424M
2160p UHDTV1	2160P_5000_SMPTE2036_UHDTV1
2160p UHDTV1	2160P_5994_SMPTE2036_UHDTV1
2160p UHDTV1	2160P_6000_SMPTE2036_UHDTV1
2160p 2SI UHDTV1	2160P_5000_SMPTE425_5_UHDTV1
2160p 2SI UHDTV1	2160P_5994_SMPTE425_5_UHDTV1
2160p 4K	2160P_5000_SMPTE2036_4K
2160p 4K	2160P_5994_SMPTE2036_4K
2160p 4K	2160P_6000_SMPTE2036_4K
Fullscreen	FULLSCREEN
User Defined	USER_DEFINED

For PAL and NTSC, the aspect ratio of the format can be set to 4:3 (standard TV) and 16:9 (wide screen TV). **Fullscreen** sets the output format to the screen size on the current machine. Fullscreen also allows the modification of the frame rate setting, but not other settings. UHDTV and 4K is supported (see [UHDTV and 4K Support](#)). UHDTV and 4K formats will be displayed if the system hardware supports it.

When the **User Defined** option is clicked on it opens a panel below the output format list. The user defined output format can be used to fit the requirements of multi-pipe systems, such as a video wall. The multi-pipe settings can be configured in the right part of the editor.

User Defined

X	0	▲▼	▲▼	▲▼	▲▼
Y	0	▲▼	▲▼	▲▼	▲▼
Width	1920	▲▼	▲▼	▲▼	▲▼
Height	1200	▲▼	▲▼	▲▼	▲▼
Frame	50.0	▲▼	R		
Aspect	1.6	▲▼	R		

Setup of multi-pipe systems should be performed by experienced system engineers. For more information, please contact your local Vizrt representative.

- **X:** Sets the horizontal alignment in pixels on the screen. Value is calculated from top left of the screen.
- **Y:** Sets the vertical alignment in pixels on the screen. Value is calculated from top left of the screen.
- **Width:** Sets the width in pixels.
- **Height:** Sets the height in pixels.

- **Frame:** Sets the refresh rate/frequency per frame in hertz (Hz).
- **Aspect:** Sets the aspect ratio. For example 1.778:1 which is 16:9 or 1.333:1 which is 4:3.

.....
Note: Make sure that the physical refresh rate of the graphics hardware and the video hardware is configured correspondingly.

There are 3 frequency groups/families; 50, 59,94 and 60 Hz. This defines the output format, and how fast Viz Engine operates. The frequency is the same as frames per second. This will also define the input format that is allowed; hence, an NTSC SD input cannot produce a PAL SD output, but an HD input with the same frequency as the SD output would work.

5.20.1 UHDTV and 4K Support

- UHDTV and 4K resolution is currently supported on *Matrox X.mio3* and *DSX.LE3/4KO*.
- For most usages X.mio3 is currently the recommended video board, for details and configuration settings see [Matrox X.mio3](#).
- For UHDTV and 4K output please carefully observe these requirements:
 - **UHDTV (3840x2160)** is supported on DSX.LE3/4KO and X.mio3.
 - **4K (4096x2160)** is supported on DSX.LE3/4KO only (DSX.LE3/4KO does not support any other resolutions).
 - 3G Level B for UHDTV is supported on DSX.LE3/4KO and X.mio3. 3G Level B for 4K is supported on DSX.LE3/4KO only.
 - To output fill and key in UHDTV and 4K on a DSX.LE3/4KO *two* video boards are required. One board will provide fill, the other board provides the key. X.mio3 with at least 8 outputs will support fill and key.
 - UHDTV and 4K setups **always** need correct genlocking. When two DSX.LE3/4KO video boards are used both boards need to be genlocked to the same sync source.
 - *Inputs* are not yet supported in UHDTV and 4K.

5.21 Plugins

The Plugins panel lists all installed plug-ins recognized as valid. To display all information correctly, you must open Viz Config from Viz Artist, as the plug-ins are not actually loaded in the Viz Config standalone application. However you can still enable or disable the loading state. Some unlicensed plug-ins will not load, while others will. In the latter case, a watermark will be shown.

Viz Artist/Engine does not load inactive plug-ins during run-time. If a scene uses a plug-in that is deactivated, Viz Artist/Engine is unable to activate it without restarting.

Field	Name	Filename	Version	req. Ver.	Loading	Data Info
Default	ZSphere	ZSphere.vip	1.0.1	No V-Req.	On	OK
Default	ZSphereMap	ZSphereMap.vip	2.0.0	No V-Req.	On	OK
Default	ZSphereBox	ZSphereBox.vip	2.0.0	No V-Req.	On	OK
Default	AlphaMap	AlphaMap.vip	1.0.0	No V-Req.	On	OK
VisualDataTools	AreaChart	AreaChart.vip	1.2.14	No V-Req.	On	OK
Default	Arrow	Arrow.vip	1.0.0	No V-Req.	On	OK
VisualDataTools	BarChart	BarChart.vip	1.2.14	No V-Req.	On	OK
Default	Circle	Circle.vip	1.1.0	No V-Req.	On	OK
RealFX	Clock	Clock.vip	1.0.0	No V-Req.	On	OK
Default	CoprHead	CoprHead.vip	1.0.0	No V-Req.	On	OK
Default	Cone	Cone.vip	1.0.0	No V-Req.	On	OK
Default	Connector	Connector.vip	1.1.0	No V-Req.	On	OK
Default	Cube	Cube.vip	1.0.0	No V-Req.	On	OK
Default	Cylinder	Cylinder.vip	1.1.0	No V-Req.	On	OK
Default	Cylinder2	Cylinder2.vip	1.1.0	No V-Req.	On	OK
Default	Distant	Distant.vip	1.0.0	No V-Req.	On	OK
Default	DisplayAsMap	DisplayAsMap.vip	1.0.0	No V-Req.	On	OK
Default	Ellipse	Ellipse.vip	1.1.0	No V-Req.	On	OK
Default	Fds, Rectangle	Fds, Rectangle.vip	1.1.0	No V-Req.	On	OK
Default	Flare	Flare.vip	1.1.0	No V-Req.	On	OK
Default	Grid	Grid.vip	1.0.0	No V-Req.	On	OK
Default	Grid2D	Grid2D.vip	1.0.1	No V-Req.	On	OK
Default	Icosahedron	Icosahedron.vip	1.1.0	No V-Req.	On	OK
Default	Image	Image.vip	1.0.1	No V-Req.	On	OK
VisualDataTools	LineChart	LineChart.vip	1.2.14	No V-Req.	On	OK
Default	Nudge	Nudge.vip	1.1.0	No V-Req.	On	OK
Premiere	Nudge2	Nudge2.vip	1.1.0	No V-Req.	On	OK
VisualDataTools	Patch	Patch.vip	1.2.14	No V-Req.	On	OK
Default	Penner	Penner.vip	1.0.0	No V-Req.	On	OK
RealFX	PlanetEnergyBot	PlanetEnergyBot.vip	1.1.0	No V-Req.	On	OK

Plug-in categories are:

- **Geometry**
- **Container**
- **Scene**
- **Shader**
- **Fontstyle**
- **RenderToDisk**
- **Inactive**

For detailed information about the various available plug-ins, see the [Viz Artist Use Guide](#) in these sections:

- **Geometry Plug-ins**
- **Container Plug-ins**
- **Scene Plug-ins**
- **Shader Plug-ins**

All plug-ins can individually be activated or deactivated. If a plug-in is inactive it will not be loaded at startup. All inactive plug-ins are listed under the **Inactive** panel.

Click the drop-down menu to select a plug-in category.

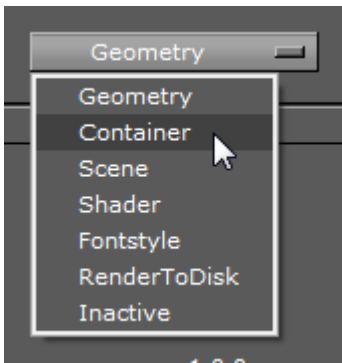

See Also

- [Viz License Information](#)

5.22 Render Options

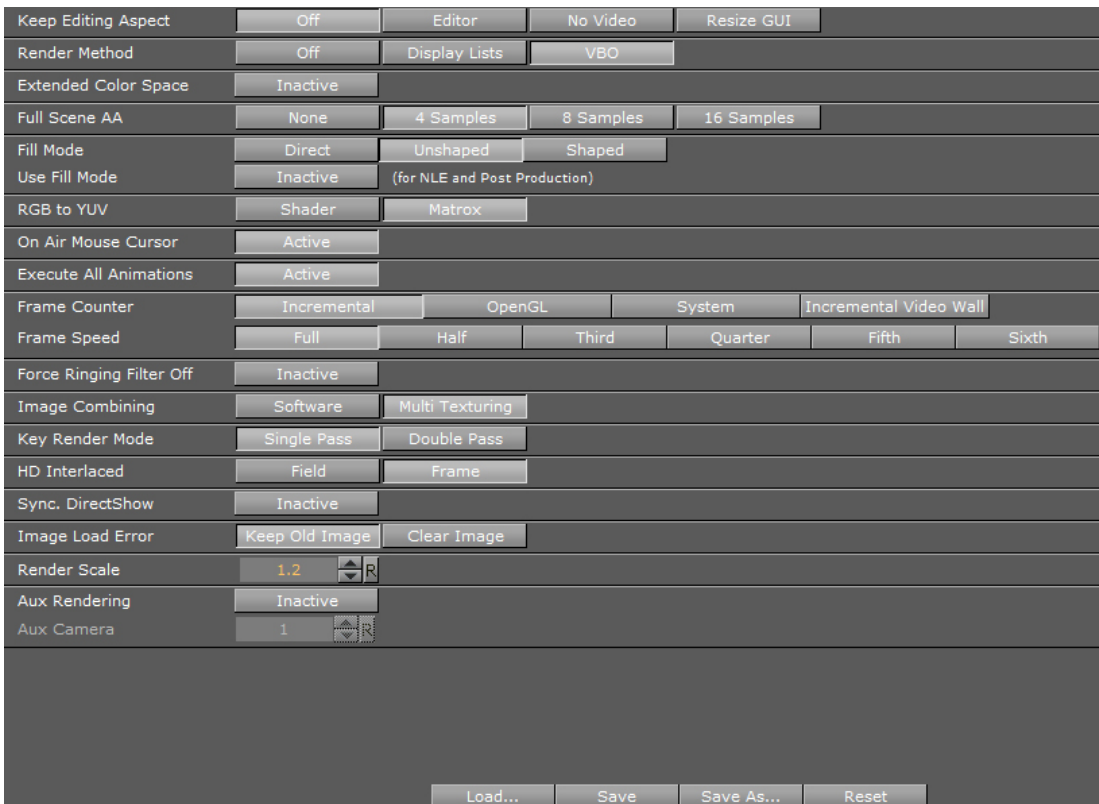

In this section, the following render options can be set:

- **Keep Editing Aspect:** Influences scene designs in Viz Artist mode. Options are:
 - **Off:** Scenes are only shown in Anamorphic wide-screen in the 4:3 VGA render window.
 - **Editor:** Scenes are shown using a letter-box format during scene editing giving designers the option to set a user defined camera aspect ratio (under *Scene Settings -> Rendering*). On Air and Viz Engine modes are not affected.

- **No Video:** Scenes are shown using a letter-box format as long as the video out is inactive. If video out is active scenes are shown in Anamorphic wide-screen in Viz Artist mode.
- **Resize GUI:** Increases the renderer window when editing 16:9 scenes to 16:9 format. On-Air and Viz Engine modes are not affected.
- **Render Method:** Set the use of **Display Lists**, **VBO** (Vertex Buffer Object), or **Off**:
 - **Off:** Geometries have to be redefined in each render step.
 - **Display Lists:** Used to buffer the geometry definition, which can then be drawn faster. The display list only needs to be updated if the geometry or its parameter changes.
 - **VBO:** Vertex Buffer Object is the default Render Method. Filling a **VBO** is faster than creating a display list, which means VBO can give a performance boost if there are several geometry changes or rebuilds in a Scene design. **VBO** is a required setting for object background loading (see **Background Loading** in the Viz Artist User Guide).

.....
Note: When rendering transparencies, the output from VBOs and Display Lists may differ slightly. Because of this, the render method will fall back to Display Lists in objects with transparency properties, for compatibility reasons.

- **Extended Color Space:** Not in use.
- **Full Scene AA:** Sets the hardware Anti-aliasing (provided by the graphics card). Options are:
 - **None**
 - **4 Samples**
 - **8 Samples**
 - **16 Samples**
- **Fill Mode:**

.....
Note: If using a Matrox X.mio2 card, any adjustments to the Fill Properties will have immediate effect during operation. For the X.mio2+ and X.mio3 video boards, Viz Engine will need to be restarted for the changes to take effect.

- **Direct:** Unmodified fill output.
- **Unshaped:** Brightened fill when AutoKey is enabled.
- **Shaped:** Fill is pre-multiplied with key.
- **Use Fill Mode (for Post Production and NLE):**
 - **Active:** Use Fill Mode for Post Production and NLE.
 - **Inactive:** Fill mode is not used for Post Production and NLE.
- **RGB to YUV:** Enables color conversion either in the Shader or on the Matrox board. When alpha on the output is turned off on systems with either the Matrox X.mio3 in **Fast Texture Mode** or the Matrox DSX LE4, **RGB to YUV** must be set to **Shader**. In all other cases, the recommended setting is **Matrox**.
- **On Air Mouse Cursor:** Enable a mouse cursor when in On Air mode and using interactive applications. Should be disabled for Video Wall and when DVI out is enabled.
- **Execute All Animations:** When deactivated this setting will enable Viz Engine to only animate visible objects. Default is Active.
- **Frame Counter:** Select the Frame Counter type for animations. This setting takes effect for Standard-PC versions, that use NVIDIA cards and drivers:
 - **Incremental:** Increases the field counter with every field (smooth animations).

- **OpenGL:** Tries to requests the retrace counter through OpenGL. If not possible, due to driver or hardware problems, it falls back to the Incremental mode.
- **System:** Uses the internal CPU clock.
- **Incremental Video Wall:** In a Video Wall environment, with more than one Viz Engine, the animation on all Viz Engines should advance simultaneously (by incrementing the frame counter based on the elapsed time between render steps). If a Viz Engine runs slower than real-time, the next frame, or frames, will be skipped to catch up with the Viz Engines running real-time.
- **Frame Speed:** Enable Viz Artist/Engine to run at a slower rate than the actual refresh rate (determined by the screen speed with the use of a g-sync card). This is relevant for Video Wall applications when the scene (e.g. interactive scenes) cannot run real-time (resource intensive), which means that all participating computers are synced to a lower speed. Running at 30Hz (screen speed 60Hz divided by 2) can be acceptable, however, this will affect the animation quality (animation will not be as smooth).
- **Force Ringing Filter Off:** Set active to overrule ringing filter (forces it off). Forcing ringing filter off can enhance performance at the cost of possibly introducing visual artifacts, typically bands or edges near edges. It is advisable to keep the default value.
- **Image Combining:** In a Texture Editor (see [Texture Editor](#) in the [Viz Artist User Guide](#)) it is possible to set a second texture which will be used for the image combining. The Texture Editor offers two possible modes: The first mode uses the second image as an alpha channel, whereas the second mode defines a blend between the two textures. Configuring Image Combining to Software enables the combination to be calculated entirely on the CPU. Configuring Image Combining to **Multi Texturing** enables the combination to be calculated on the graphics card for combining or blending the two images. In this case the texture creation is faster and memory will be saved as well. Default is Software. If there are performance or memory issues, especially with scenes imported from Viz Artist/Engine 2.x, it is recommended to change this setting to Multi Texturing.

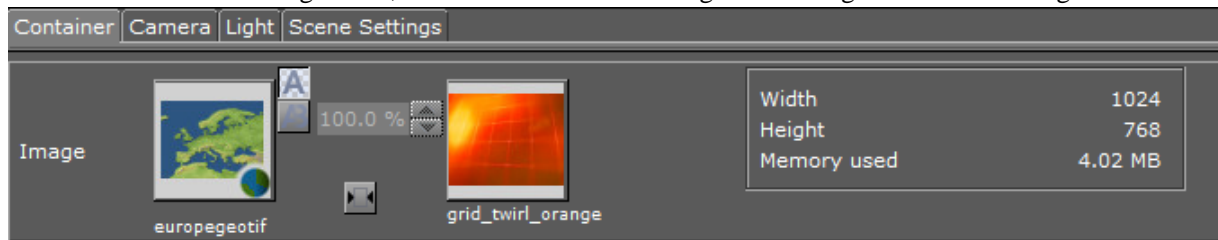

- **Key Render Mode:** This configuration is used when the **Key Render Mode** (see [Global Settings](#) in [Scene Settings](#) (see the [Viz Artist User Guide](#))) is set to **Config**, and determines how the key should be rendered:
 - **Double Pass:** Uses two rendering steps as in older 3.x versions. Double Pass should be used for old 3.x scenes for not breaking compatibility, for new scenes Single Pass should be used as it is faster.
 - **Single Pass:** Uses one rendering step as in 2.8 versions.

A shaped video image has its video data multiplied by its alpha component (1) while the video data of an unshaped image remains untouched (2). Shaped images are also referred to as 'pre-multiplied alpha images'.

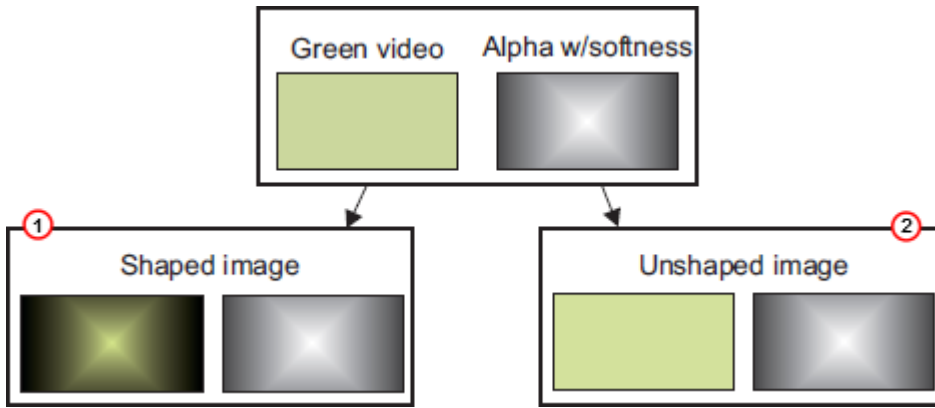

- **HD Interlaced:** Specifies if Viz Engine should render frames or fields for interlaced HD formats (i.e. 1080i). Rendering frames improves the rendered output but has a higher performance cost. Options are:
 - **Field**
 - **Frame**
- **Sync. DirectShow:** Synchronize DirectShow clip playback with renderer (may cause video jumps and audio cracks).
- **Image Load Error:** If an image load error occurs you can configure Viz Engine to keep the old image or clear the image (i.e. not showing anything).
- **Render Scale:** Change the render scale when using a tracking system with lens distortion.
- **Aux Rendering:** Activates the rendering pipeline for integration with third party render engines.
- **Aux Camera:** Camera for auxiliary rendering pipeline.

5.23 Scene Default Values

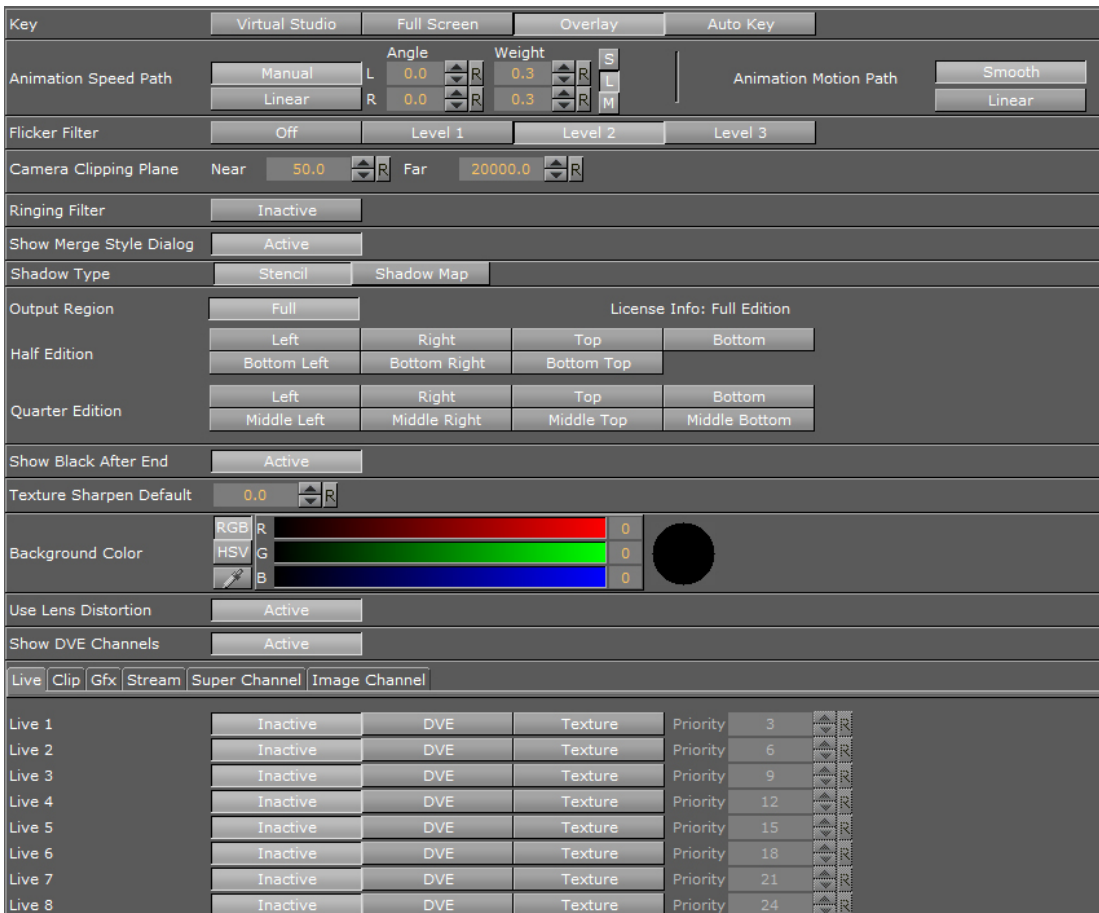

This section configures the default values for new scenes.

- **Key:** Sets the key mode. Alternatives are; **Virtual Studio**, **Full Screen**, **Overlay**, and **Auto Key**.
- **Animation Speed Path:** Set the default animation speed either to **Manual** or **Linear**, and define the default **Angle** and **Weight**.
- **Animation Motion Path:** Defines the default motion path between position key frames. When set to *Smooth* the motion path will be calculated as a Bezier curve between position key frames. Handles will be added to the key frame positions in the preview window to allow for path editing. When set to *Linear* the animated object will follow a straight line between position key frames. This setting can be changed individually under **Path**, in the Viz Artist Channel Editor.
- **Flicker Filter:** When enabled it will reduce interlaced flicker on high contrast objects. For example small lines and hard objects. Alternatives are; Off, and Level 1-3.
- **Camera Clipping Plane:** Sets the range of the virtual camera. Near sets the close range while far defines the far range. Only objects within this range will be rendered.
 - **Near:** Sets the Near value to clip unwanted objects from the foreground. Default value is 50.
 - **Far:** Sets the Far value to clip unwanted objects from the background. Default value is 20000.

.....
Note: The camera range is where the Z-buffer is within. So if Z-buffer problems arise, they may be solved by editing the camera clipping plane settings.

- **Ringing Filter:** Sets the default value for the Ringing Filter. A ringing filter reduces high frequency values in the video signal created by high contrast and color changes in horizontal directions.
- **Show Merge Style Dialog:** Enables the user, when opening a scene in Viz Artist, to open old-style merged objects and expose containers within it.
 - This feature relates to scenes using old-style ordering of containers within merged objects, and solves the problem with auto-follow. When loading such scenes the dialog lets the user decide how to deal with them.
 - Users that are aware of this and decide to keep the old style can deactivate this dialog.
- **Shadow Type:** Choose between **Stencil** and **Shadow Map**.
- **Output Region:** Shows which region of the screen Viz Artist/Engine is licensed to render.
- **Half Edition:** Allows Viz Artist/Engine to render half screen. Available options are; left, right, top, bottom, bottom left, bottom right and bottom top.
- **Quarter Edition:** Allows Viz Artist/Engine to render quarter screen. Available options are; left, right, top, bottom, middle left, middle right, middle top and middle bottom.
- **Show Black After End:** Shows black after a clip has finished playing.
- **Texture Sharpen Default:** Sets the default sharpen value for textures.
- **Background Color:** Set default scene background color.
- **Video Input Layer Targets and Priority:** Set the defaults for how the specific input channel should be used and its priority. Available options are, Inactive, Texture, DVE and Priority.
- **Use Lens Distortion:** Activates the Lens Distortion. For detailed settings, see [Advanced Lens Distortion](#).
- **Show DVE Channels:** If activated, the DVE Channels will be visible in the Scene Editor.

5.23.1 Media Asset Configuration

Here you can pre-configure all available media assets to the different modes of DVE or Texture. This works for Media Assets such as **Live Video**, **Clip Channels**, and **Stream Channels**. **Super Channels** and **Image Channels** can only be pre-configured as **Inactive** or **DVE**.

	Live	Clip	Gfx	Stream	Super Channel	Image Channel		
Live 1				Inactive	DVE	Texture	Priority 3	
Live 2				Inactive	DVE	Texture	Priority 6	
Live 3				Inactive	DVE	Texture	Priority 9	
Live 4				Inactive	DVE	Texture	Priority 12	
Live 5				Inactive	DVE	Texture	Priority 15	
Live 6				Inactive	DVE	Texture	Priority 18	
Live 7				Inactive	DVE	Texture	Priority 21	
Live 8				Inactive	DVE	Texture	Priority 24	

By setting the individual number and type of Media Asset to **Inactive**, **DVE** or **Texture**, the desired channel is automatically set up when dragged into the Scene Tree of new scenes. The priority option works only in DVE mode, and influences the drawing order of the defined channels.

5.24 Spaceball

The Spaceball section is used to configure a 3D navigation device.

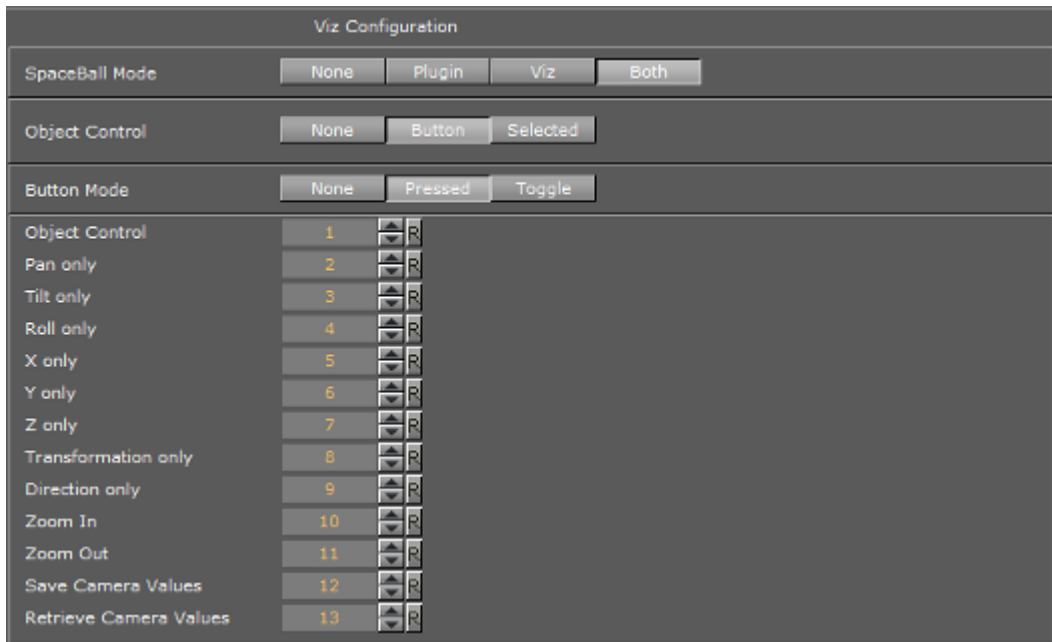

- **SpaceBall Mode:** Sets special setups where the Spaceball should only control specific plug-ins without influencing the scene (objects/camera):
 - **None:** No setup.
 - **Plugin:** Controls plug-ins.
 - **Viz:** Controls Viz Artist/Engine objects.
 - **Both:** Controls both plug-ins and Viz Artist/Engine objects.
- **Object Control:**
 - **None:** No setup.
 - **Button:** Uses button for object control.
 - **Selected:** Modifies only the selected object.
- **Button Mode:**
 - **None:** No setup.
 - **Pressed:** When set to Pressed, this mode will trigger an action like a button in a user interface.
 - **Toggle:** When set to Toggle, this mode will set a state. For example when a button is pressed only the dominant axis will be considered in a move, whereas when the button is released all movements are applied.

The numeric fields are used to map the various buttons on the 3D navigation device. This varies by the vendor and the vendors model; hence, the button numbers need to be looked up in the [Viz Artist User Guide](#) for the respective device.

Button options are:

- Object Control
- Pan Only
- Tilt Only
- Roll Only
- X Only
- Y Only
- Z Only

- Transformation Only
- Direction Only
- Zoom In
- Zoom Out
- Save Camera Values
- Retrieve Camera Values

5.25 User Interface

This section describes the user interface settings. Some of these settings are also available in Viz Artist.

- [Various](#)
- [Colors](#)
 - [Global Settings](#)
 - [To Change a Preset Color Theme](#)
 - [To Change a Subjects Color](#)
 - [Scene Tree](#)
 - [To Change the Amount of Active Colors](#)
 - [To Create a Color](#)
- [Shortcuts](#)

5.25.1 Various

Various	Colors	Shortcuts
Gui Icon Font	Verdana	
Gui Font Size	10 12 14 18	
Button Gradient	None Level 1 Level 2 Level 3	
Mouse Over Effect	Active	
Icon Size	Small Large	
Show "-Blur-" Fonts	Active	
Show "-Outline-" Fonts	Active	
Import Default Type	Archives	
Folder Type Highlighting	Inactive	
Auto Grab Focus	Active	
Reset Startup Default Folder	Reset	
Allow Folder Move	Normal w/Shift No	
Performance Update Interval	50 fields	
On Air Info Update Interval	0 seconds	
Tool Tips	On Delay On (ms) 300 Delay Off (ms) 10000	
Screen Layout Mode	Normal Mosaic Horizontal Mosaic Vertical Dual Screen	
Default Merge Mode	Merge to Subdirector w/Actions & Events w/A. & E. to Subd.	
Default Split Mode	Split to existing Dir.	
Default Color Space	RGB HSV	
Update Control Text	Off	
Script Middle Mouse Copy	Off	
Gui Timeout (ms)	360000	
Off Air Shortcut	Esc Shift+F1	

- **GUI Icon Font:** Sets the Font type for all icons of items such as scenes, objects, materials, images, fonts, and audio clips. Complex character sets such as Arabic, Hebrew and Chinese must change the default font type to show the correct names for the icons.
- **GUI Font Size:** Sets a global font size for the Viz Artist user interface. Alternatives are; 10, 12, 14, 18 pixels.
- **Button Gradient:** Sets the gradient level of the buttons in the Viz Artist user interface.
- **Mouse Over Effect:** Mouse over effect for buttons in the Viz Artist user interface. Set to Active or Inactive.
- **Icon Size:** Sets a size preference for scene, font and audio icons. Icon size can also be switched using the context menu in the server view in Viz Artist; however, changing this setting in Viz Artist will not be saved as a preference for later sessions.
- **Show "Blur" fonts:** Set the default show or hide blur fonts in the Server area. The option can then be toggled with the **Item Context Menu** (see the [Viz Artist User Guide](#)).
- **Show "Outline" fonts:** Set the default for showing or hiding the outline fonts in the Server area. The option can then be toggled with the **Item Context Menu** (see the [Viz Artist User Guide](#)).

- **Import Default Type:** Selects the default item type for imports, which will be pre-selected in the GUI **Import Menu**. Options are:
 - **Fonts**
 - **Images**
 - **Geometries**
 - **Scenes**
 - **Audio**
 - **Archives**
- **Folder Type Highlighting:** When enabled this will highlight the folders that contain content matching the current Viz Artist's Server view (for example Scene, Geometry, Material, Image, Font, Audio, etc.).

.....
Note: This can cause some performance overhead, when switching to different types and/or with opening sub folders (but only first time, as the information is cached).

- **Auto Grab Focus:** When Inactive, a middle mouse click grabs the focus, as a left and right-click do. When auto grab focus is Active, the focus is grabbed as soon as you move the mouse over a widget.
- **Reset Startup Default Folder:** Resets the startup folder. If Viz Artist is unable to start due to problems with the last saved server view, clicking the Reset button will reset the Server view to its top node.
- **Allow Folder Move:** Allow or restrict the user's ability to move/organize projects and folders in a Graphic Hub. Options:
 - **Normal:** Drag folders freely, as required to move (Default setting)
 - **w/Shift:** Press <Shift> and drag to move folder or folders
 - **No:** No folder movement allowed
- **Performance Update Interval:** Sets how often Viz Engine should update the [Performance Bar](#) when it is opened.
- **On Air Info Update Interval:** Update interval for the [On Air Information Panel](#) window. Note that a shorter interval decreases render performance. Setting to 0 means that no update occurs.
- **Tooltips:** Enables or disables the tooltip information in the Viz Artist user interface.
 - **Delay On (ms):** Sets the amount of time in milliseconds before the tool tip shows. Default is 1500 ms.
 - **Delay Off (ms):** Sets the amount of time before the tool tip disappears. Default is 4000 ms.
- **Screen Layout Mode:** Set to either:
 - **Normal:** Default screen (single monitor):

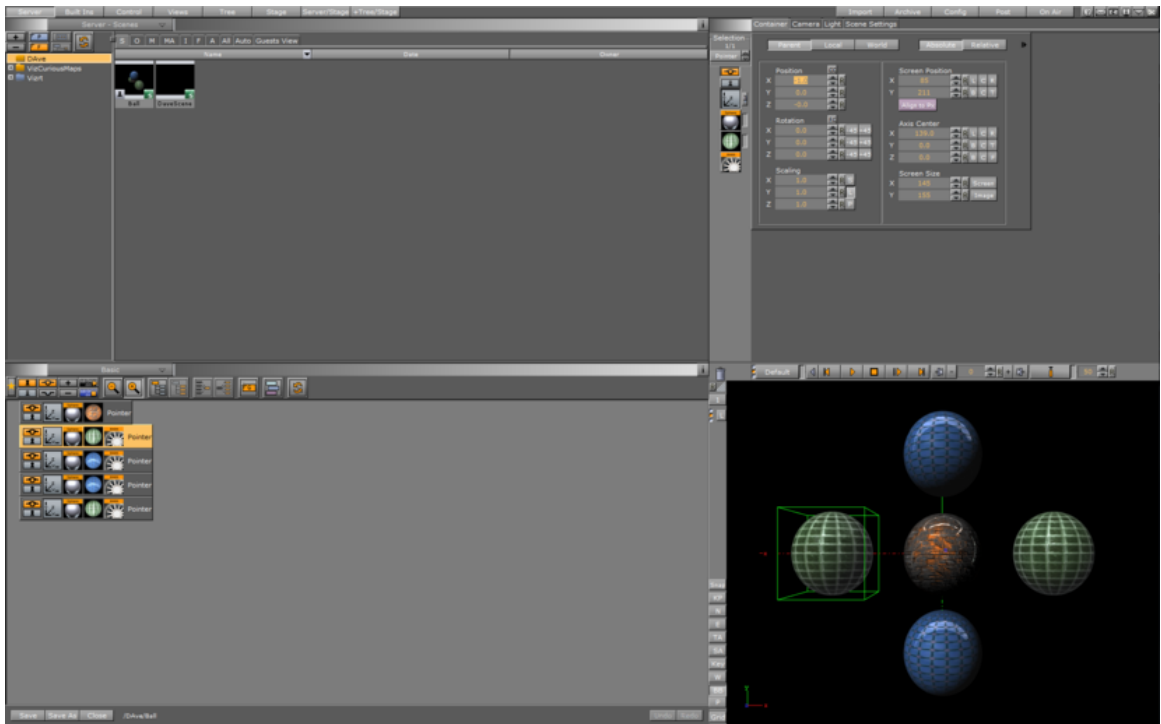

- **Mosaic Horizontal:** Viz Artist shows on the left monitor and the Scene Editor shows on the right monitor (two monitors):

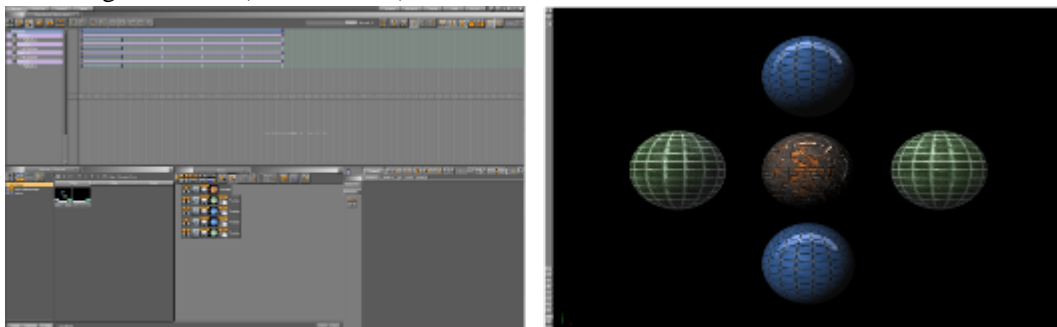

- **Mosaic Vertical:** Viz Artist shows on the top monitor and the Scene Editor shows on the bottom monitor (two monitors):

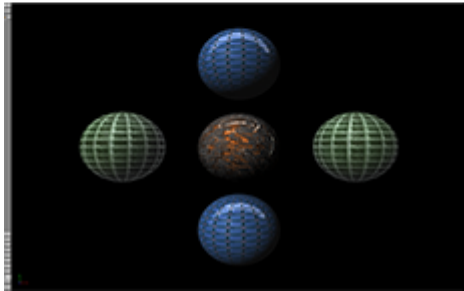
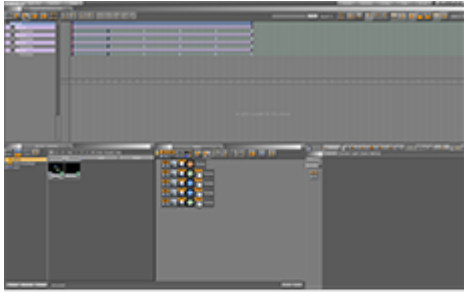

.....
Note: Mosaic Horizontal and Mosaic Vertical are only available with NVIDIA graphics cards, on systems running at least Windows 7. Open the NVIDIA properties to setup Mosaic before changing the Viz Config file.

- **Dual:** The Scene Editor opens in a new window (two monitors):

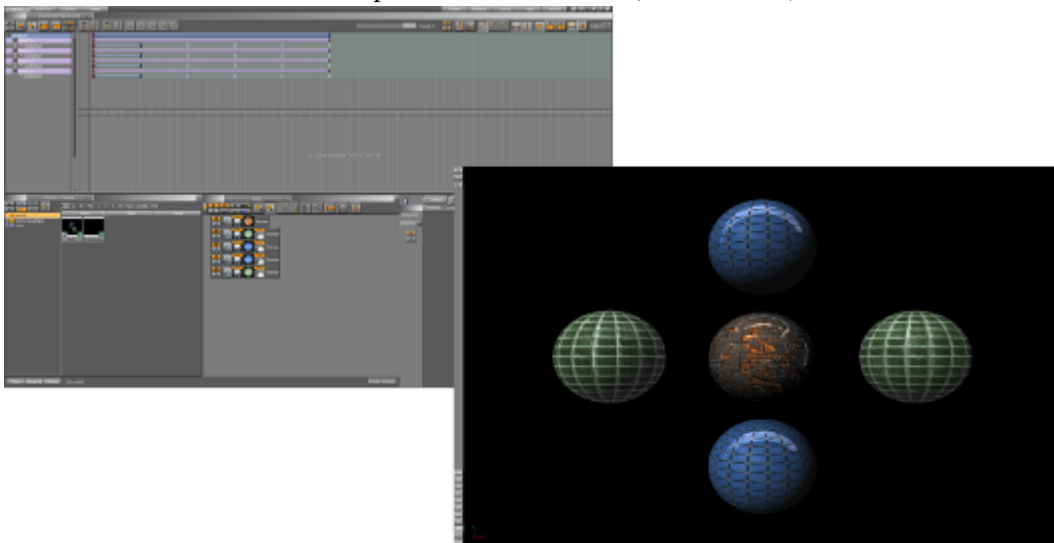

- **Default Merge Mode:** Sets the default merge behavior available in the Viz Artist user interface. Options are:
 - Merge
 - [Merge] to sub director
 - [Merge] w/actions & events
 - [Merge] w/actions and events to sub director (*w/A. & E. to Subd.*)
- **Default Split Mode:** Sets the default split behavior available in the Viz Artist user interface. Options are:
 - Split
 - [Split] to existing director

- **Default Color Space:** Select RGB or HSV as the default color space for the Material editor
- **Update Control Text:** Click to make Update Control Text active or inactive:
 - **Active:** The Control text, in Control Objects, is updated with every key stroke
 - **Inactive:** The Control text, in Control Objects, is not updated with every key stroke
- **Script Middle Mouse Copy:** Click to enable or disable the middle mouse button copy and paste function in the Script Editor.
- **Gui Timeout (ms):** Defines the timeout threshold in milliseconds when awaiting command replies from the Engine. After the specified time, a timeout dialog is displayed. The minimum and default value 180000, or 180 seconds.
- **Off Air Shortcut:** Choose the shortcut that takes the render On Air window to Off Air.

.....
Tip: Adjust the timeout value if timeouts occur when loading very large scenes in Viz Artist.

5.25.2 Colors

The Colors tab gives the ability to change the User Interface color theme.

Global Settings

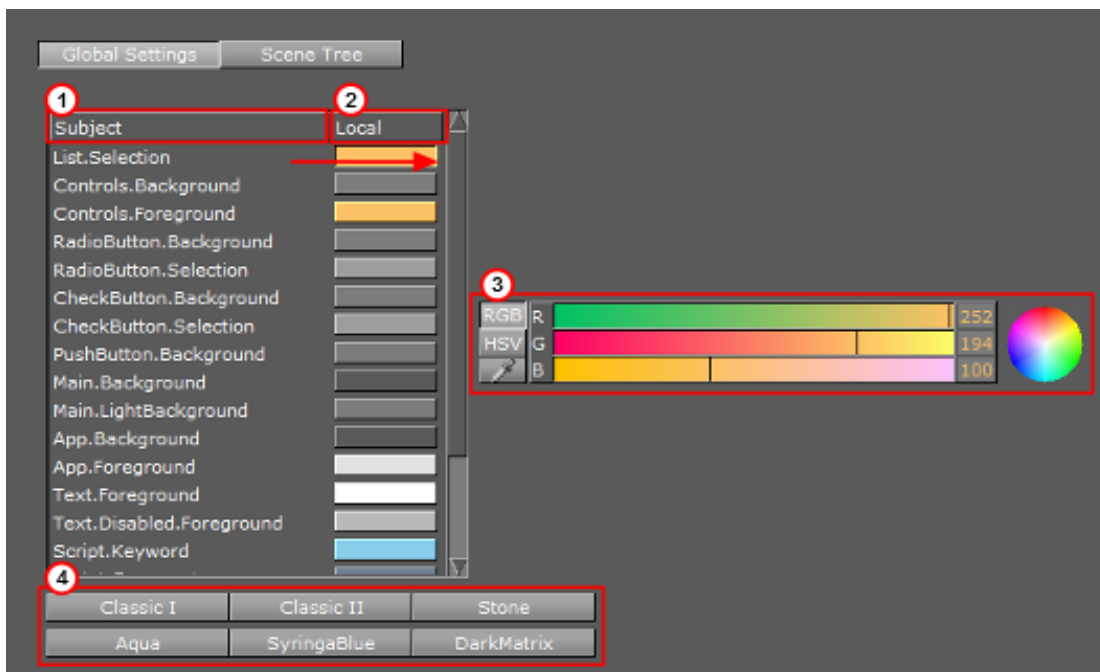

Use Global Settings to change the color theme of the User Interface. All the changes made to the User Interface are local. Click **Save** then restart Viz Artist for the changes to take effect.

There are six pre-set color themes (4):

- Classic I
- Classic II
- Stone (default)

- Aqua
- SyringaBlue
- DarkMatrix

To Change a Preset Color Theme

- Click on a preset color theme (4).
Individual parts of the User Interface can be assigned a new color, if the part is listed in the Subject panel (1).

To Change a Subjects Color

1. Click on a Subjects color bar in the Local panel (2).
2. In the color selection area (3) select RGB or HSV.
3. In the color selection area, click a color bar, or the color circle, and drag to change the color.
or

1. Drag one of the current Subjects color (in the Local field).
2. Drop it onto another Subjects Local field.
or

1. Click on the eye dropper icon in the color bar.
2. Move the cursor to an area, color on-screen.
3. Click to accept the new color.

Scene Tree

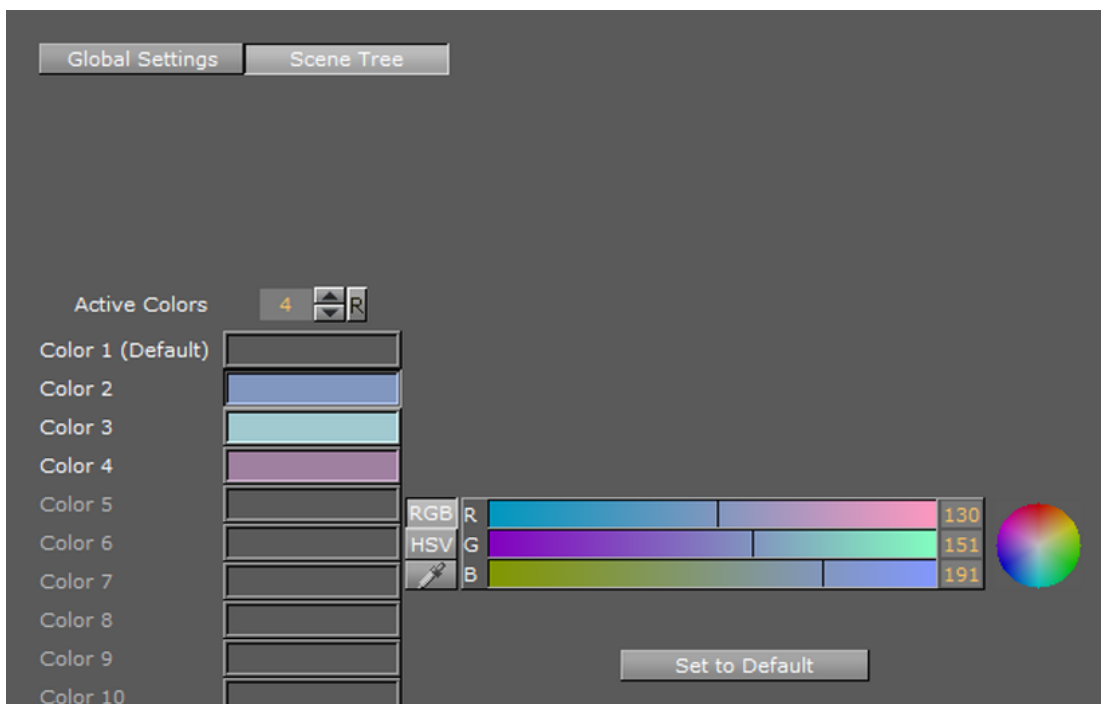

Use the Scene Tree panel to set the color codes for Containers in the Scene Tree. A Container with a color code can be searched for in the Scene Tree, and the Scene Tree can be restricted to Containers with certain colors (see **Scene Tree Menu** in the [Viz Artist User Guide](#)).

A text tag can also be added to the color. The text is Scene specific and saved with the Scene on the Graphic Hub. Note that the colors might change if the Scene is opened on a different machine with a different color setting.

Example: All text Containers can be colored gray and tagged Text, while all Containers that hold images can be colored green and tagged Image, and so on.

Four colors are configured and active by default with no text descriptions. Click **Set to Default** to set all color bars to their default setting.

The color options are available in the GUI **Scene Settings** panel in the Tree Color Text setting, and available for use in the Scene Tree panel.

To Change the Amount of Active Colors

- In the **Active Colors** field enter the amount of colors to be active. Up to 16 colors can be configured and made active.

To Create a Color

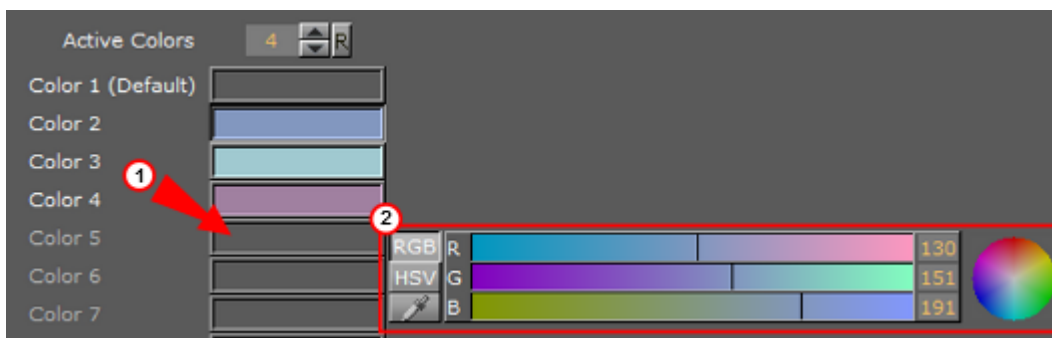

1. Click on a unused color bar (1). It is also possible to change the color of the first four colors. Click in their color bar.
 2. In the color selection area (2) select RGB or HSV.
 3. In the color selection area, click a color bar, or the color circle, and drag to change the color.
 4. If required: Click the color bar (1) and enter a name for it.
- or

1. Click on the eye dropper icon in the color field.
2. Move the cursor to an area, color on-screen.
3. Click to accept the new color.

5.25.3 Shortcuts

The shortcuts view shows all available server, scene tree and property actions and the currently assigned shortcuts. All shortcut configurations are saved to the database into the user table for personalization.

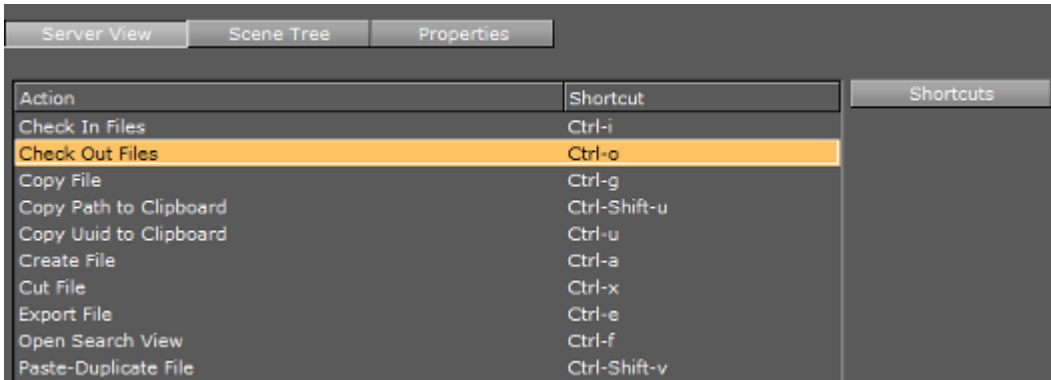

- **Server, Scene Tree and Properties:** Shows all server actions and their currently assigned shortcuts.
- **Shortcuts:** When clicked, shows a list of available shortcut key-combinations that can be assigned to the selected action.
- **Reset All:** Resets all shortcuts to the default setup.

5.26 Video Board

This section is used to configure video input, output and clip playback related settings.

.....
Note: Not available on VGA versions of Viz Engine.
.....

5.26.1 Video Board Properties

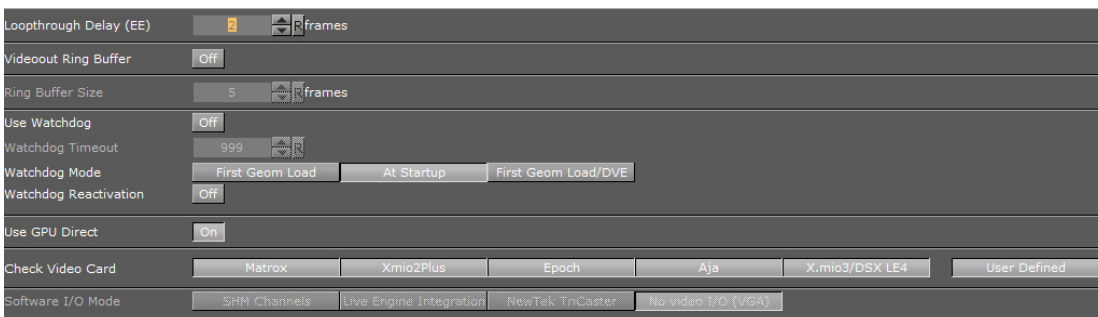

- **Loophthrough Delay (EE):** Set the delay for live video input (DVS, Bluefish and NVIDIA SDI boards only). This setting applies for all input channels. For Matrox, see Video Delay DVE in Video Properties.
- **Videout Ring Buffer:** Sets the render buffer for video output. Helps to prevent frame drops on the video output during execution of commands or loading of objects. When enabled the engine will render a number of graphics frames in advance and provide it to the video hardware. The number of frames rendered forwardly is defined by the Ringbuffer Size. Large buffer sizes will delay the output and increase the input to output delay for video textures.

- **Ring Buffer size:** Sets the size of the Ringbuffer in frames.
- **Use Watchdog:** Set Watchdog On or Off:
 - **Matrox:** See [Watchdog](#).
 - **Bluefish:** See [Special Configuration Options for Bluefish444](#) in the [BlueFish444](#) chapter.
- **Watchdog Timeout:** Set the time, in milliseconds, until the watchdog takes over control. This value should not be smaller than the time of two fields/frames. Default value is 999 milliseconds
- **Watchdog Mode:** Set the Watchdog mode:
 - **First Geom Load:** Video Out is activated when the first geometry is loaded.
 - **At Startup:** Video Out is activated at startup.
 - **First Geom Load/DVE:** Video Out is activated when the first geometry is loaded or an input or clip channel is set to DVE.
- **Watchdog Reactivation:** Set to **On** to activate the watchdog again if scenes are unloaded from renderer.
- **Use GPU Direct:** Set to **On** to enable a fast, low latency method to copy frames from the video IO device to the GPU and back (gives more time for the renderer to process complex and GPU intense visual effects).
- **Check Video Card:** Select which video cards to search for and use when Viz Artist/Engine is started. If a video card is not selected it is not used, even if it is installed in the system. All cards are enabled by default.

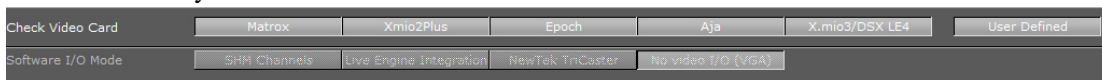

- **Select Individual Cards:** If **User Defined** is selected, click on each listed card to select or unselect, as required.

.....
Note: If a Matrox X.mio3 card is installed in the system and X.mio3/DSX LE4 is disabled, the card will be treated like a Matrox X.mio2 Plus card.

- **User Defined:** To select and use individual cards, select **User Defined**.
- **None:** If **None** is selected, all connected video cards will be unavailable for Viz Engine and Viz Artist. This can be used to run a Viz Artist video version as a VGA version, even if video cards are installed. Possible use-cases for this are:
 1.
 - a. Dual channel Viz Trio One Boxes, which have three Viz Artist/Engine instances running and where only the first two should use the video board. The third Engine instance is exclusively for Trio preview.
 - b. With TriCaster implementation, where Viz Artist must run as a video version, running as VGA.
 - c. If utilizing the **Stryme integration** capabilities of Viz Engine, where Viz Engine hooks on to **Stryme GenesiX** to allow Stryme to show Vizrt graphics on its output. Please refer to the procedure below for further information on Stryme Integration.
- **Software I/O Mode:** Set a specific Video I/O mode for setups without video hardware or configurations where **Check Video Card** is set to None. Not available in the VGA version.

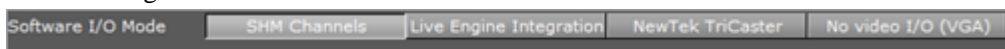

- **SHM Channels:** I/O mode for third party software utilizing the Viz SHMLib software library.

- **Live Engine Integration:** Optimized I/O mode for Live Engine Integration with Viz Libero. Refer to the Viz Libero documentation for further details.
- **NewTek TriCaster:** Uses the NewTek TriCaster input and outputs. Read more about using TriCaster with Viz Engine and Artist in the Third Party Applications and Files chapter of the [Viz Artist user's guide](#).
- **No video I/O (VGA):** Disables all video version features, emulating the VGA version of Viz Engine.

To Enable Stryme Integration

To enable integration with Stryme, the Viz configuration file needs to be manually edited. Please make sure to create a backup copy of the configuration file before making any changes.

1. Locate and open the Viz configuration file.
2. Locate the section `SECTION CHANNELS_CONFIG`
3. Add the following lines:

```
StrymeOut.Enable = 1 StrymeOut.RingbufferSize = 10 StrymeOut.SHMname = Global\Genesix.MediaEngine.Matrox.SharedMem.0
```

- **StrymeOut.Enable:** Enables or disables the Stryme integration capabilities of Viz Engine. If the Stryme Integration is no longer needed at a later time, it can easily be disabled by changing the value of `StrymeOut.Enable` to 0.
- **StrymeOut.RingbufferSize:** Defines the size of the ringbuffer, and can be omitted. If omitted, the default value will be 10. Valid values are in the range of 1-100.
- **StrymeOut.SHMname:** Defines the name of the Shared Memory name as defined by Stryme GenesiX, and can be omitted. If omitted, it will default to `Global\Genesix.MediaEngine.Matrox.SharedMem.0`.

.....
IMPORTANT! Stryme integration works **only** with Viz Engine in VGA mode or with **Check Video Card** set to **None** (see above).

5.27 Video Input

Video input channels are enabled or disabled in this section. To be able to use a Live input channel, a Clip channel or a Stream channel, it first has to be set to active in this panel.

- [Live and Clip Channels](#)
- [Stream Channels](#)
- [No Onboard Video Board](#)

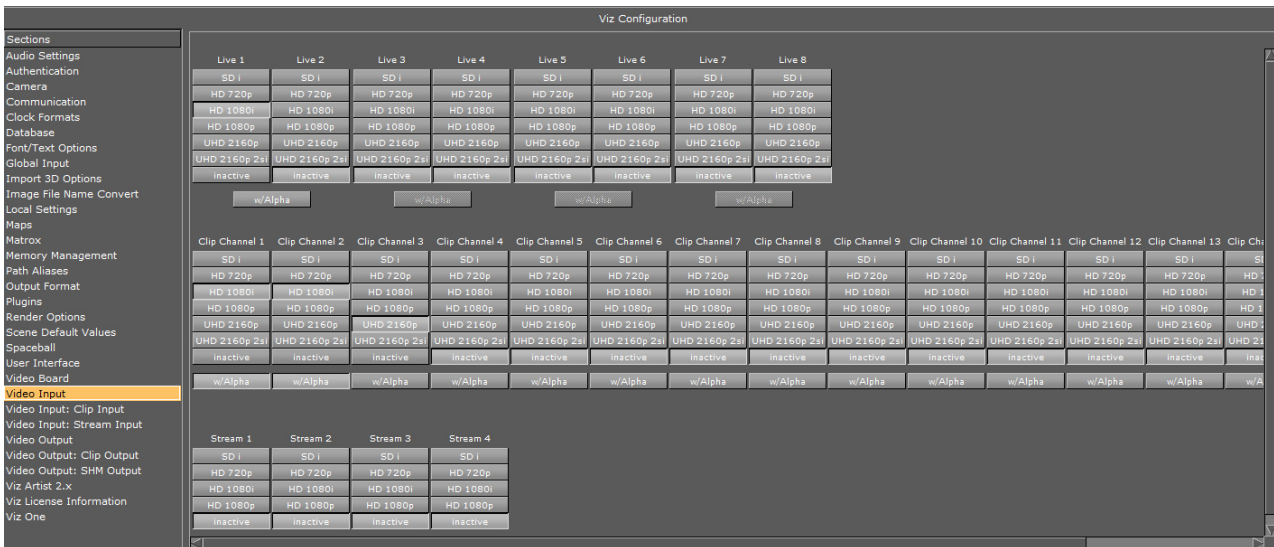

The frequency of the channels is defined in the [Output Format](#) section.

5.27.1 Live and Clip Channels

This panel activates the Live input and Clip channels and defines the video standard that the channel is configured to. It is possible to mix video standards, for example, a Viz Engine configured to play out 1080i50 can have inputs configured to SD.

- **Live w/Alpha:** For the Input this will combine the two (Live 1 and Live 2) channels to one channel carrying fill and key. This means that the Y (luminance) from Live 2 in YUV will be used as the key signal.
- **Clip Channel w/Alpha:** When enabled the clip file must either contain key information or a key clip must be provided. The key clip must have the string “_key” appended to the filename. For a clip named *i422_50M.avi* this would be *i422_50M_key.avi*.

.....
Note: Video input format may be limited by hardware capabilities on the video board.

5.27.2 Stream Channels

The Stream channels are for live video streams (see [Video Playback From a Video Stream](#) in the [Viz Artist User Guide](#)). Set each Stream to active or inactive.

5.27.3 No Onboard Video Board

Sections	Live 1	Live 2	Live 3	Live 4
Audio Settings	SD i	SD i	SD i	SD i
Authentication	HD 720p	HD 720p	HD 720p	HD 720p
Camera	HD 1080i	HD 1080i	HD 1080i	HD 1080i
Communication	HD 1080p	HD 1080p	HD 1080p	HD 1080p
Clock Formats	UHD 2160p	UHD 2160p	UHD 2160p	UHD 2160p
Database	UHD 2160p 2si	UHD 2160p 2si	UHD 2160p 2si	UHD 2160p 2si
Font/Text Options	inactive	inactive	inactive	inactive
Global Input				
Import 3D Options				
Image File Name Convert				
Local Settings				
Maps				
Matrox	Clip Channel 1	Clip Channel 2	Clip Channel 3	Clip Channel 4
Memory Management	SD i	SD i	SD i	SD i
Path Aliases	HD 720p	HD 720p	HD 720p	HD 720p
Output Format	HD 1080i	HD 1080i	HD 1080i	HD 1080i
Plugins	HD 1080p	HD 1080p	HD 1080p	HD 1080p
Render Options	UHD 2160p	UHD 2160p	UHD 2160p	UHD 2160p
Scene Default Values	UHD 2160p 2si	UHD 2160p 2si	UHD 2160p 2si	UHD 2160p 2si
Spaceball	inactive	inactive	inactive	inactive
User Interface				
Video Board				
Video Input				
Video Input: Clip Input				
Video Input: Stream Input				
Video Output	Stream 1	Stream 2	Stream 3	Stream 4
Video Output: Clip Output	SD i	SD i	SD i	SD i
Video Output: SHM Output	HD 720p	HD 720p	HD 720p	HD 720p
Viz Artist 2.x	HD 1080i	HD 1080i	HD 1080i	HD 1080i
Viz License Information	HD 1080p	HD 1080p	HD 1080p	HD 1080p
Viz One	inactive	inactive	inactive	inactive

When there is no installed video board (standard-PC) the video input section no longer shows the Alpha options for Live and Clip. Video input for standard-PC versions enable clip playback through the Properties Panel.

5.28 Video Input: Clip Input

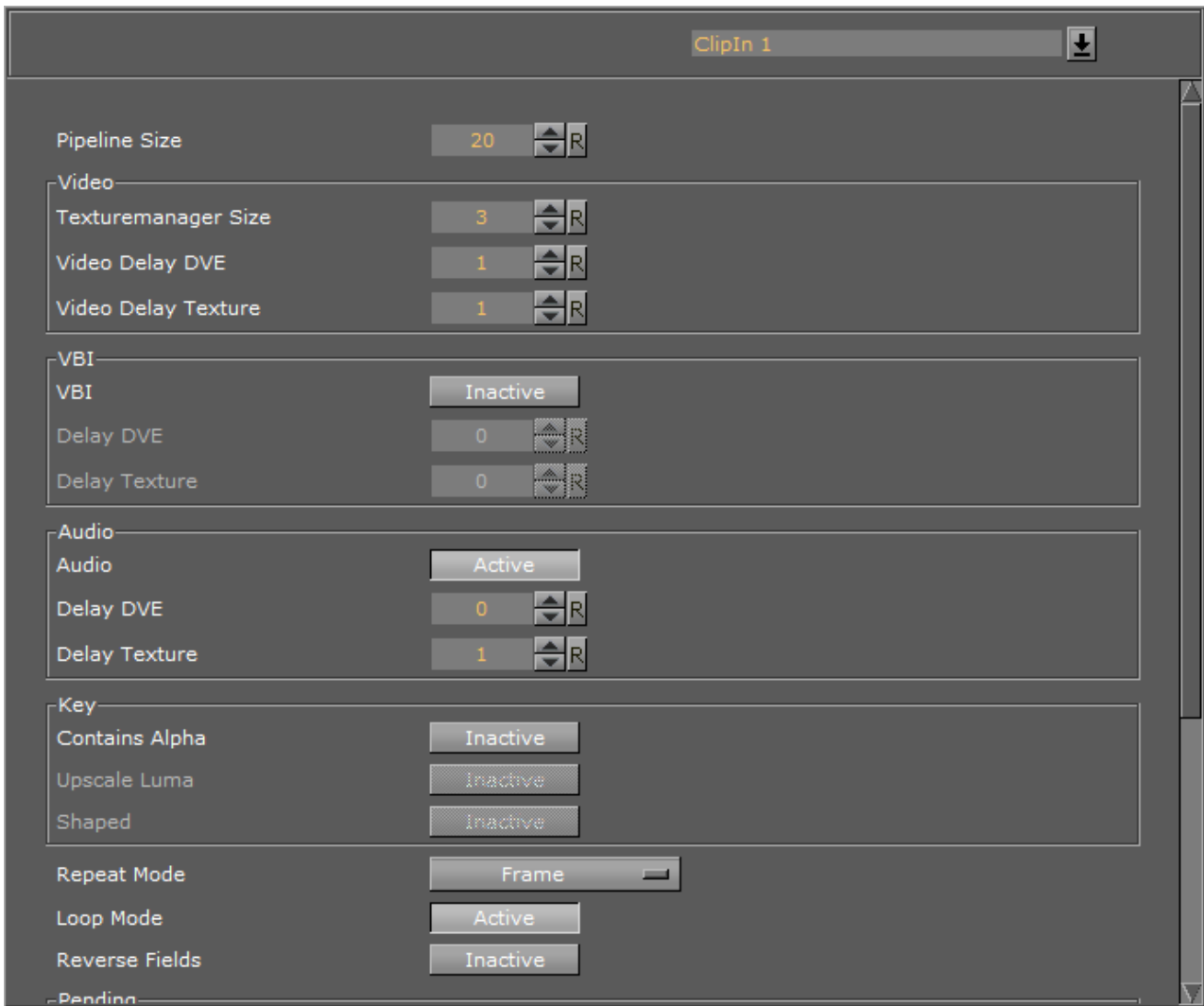

Use the Video Input: Clip Input panel to configure available playback channels. The number of available clip input channels is set in [Video Input](#).

See Also

- [Matrox](#)

5.28.1 Clip Input Properties

- **Pipeline Size:** Defines the number of frames Matrox' internal clip reader buffer should buffer in advance. Default value is 20.
- **Texturemanager Size:** Texture download buffer size.
- **Video Delay DVE:** DVE Delay of video when used as DVE.
- **Video Delay Texture:** Texture Delay of video when used as Texture.
- **VBI:** Set to Active or Inactive. Defines whether VBI should be used for this channel. Default mode is Inactive.
- **Delay DVE:** Sets the number of frames VBI should be delayed, before the clip can be used, in DVE mode. Default value is 0 (Off).

- **Delay Texture:** Sets the number of frames VBI should be delayed, before the clip can be used, in texture mode. Default value is 1.
- **Audio:** When activated, this setting enables audio for this channel. When inactive audio is disabled. Default value is Activated.
- **Delay DVE:** Sets the number of frames the audio clip should be delayed in DVE mode before it can be mixed to the output. Default value is 4.
- **Delay Texture:** Sets the number of frames the audio clip should be delayed in texture mode before it can be mixed to the output. Default value is 4.
- **Contains Alpha:** Enables/disables playback of clips with alpha.
- **Upscale Luma:** Enables/disables the default for upscale luma. Per scene setting of this value is set per clip channel under Scene Settings and Video clip options.
- **Shaped:** Defines whether the fill from this channel, when the channel is used in DVE mode, should be interpreted as shaped video during DVE compositing. Default value is Inactive.
- **Repeat Mode:** Determines the behavior of the video input in case of capture drops. Options are:
 - **None:** Does not repeat. Input goes black.
 - **Field:** Repeats the last field.
 - **Frame:** Repeats the last frame.
- **Loop Mode:** Enables/disables default for loop mode. Per scene setting of this value is set per clip channel under Scene Settings and Video clip options.
- **Reverse Fields:** Swaps fields when playing interlaced clips with negative playback speed (default setting). Per scene setting of this value is set per clip channel under Scene Settings and Video clip options.
- **Pending Enable:** Enables/disables pending clip player for this channel. The pending clip player allows clip loading of another clip while the clip channel is still using the current clip.
- **Mode on Load Error:** Determines the behavior of the current clip when loading of the pending clip fails. Options are:
 - **None:** Current clip mode is not changed.
 - **Stop:** Performs a Stop command on the current clip.
 - **Pause:** Current clip enters pause mode.
 - **Flush:** Unloads the current clip.
- **Proxy:** If set to Active, video clips of a resolution different to the current configured resolution, can be played. If set to Inactive a video clip of a different resolution cannot be played.
- **Reactivation Delay:** Set the minimum number of frames the texture contains black after the channel was activated to texture.
- **Ringbuffer:** If set to Active the input ringbuffer is enabled when played with a NVIDIA SDI output.

5.29 Video Input: Stream Input

Use the Video Input: Stream Input panel to configure available IP stream input channels. The number of available IP Stream input channels is set in [Video Input](#).

5.29.1 Stream Input Properties

Map to Viz Channel	Stream1	
ProcAmp		
Brightness	0	
Lumagain	0	
Hue	0	
Saturation	0	
Allow Super Black	Active	
Allow Super White	Active	
Allow Chroma Clipping	Inactive	
Key		
Contains Alpha	Inactive	
Key Apply Offset	Inactive	
Key Upscale Luma	Active	
Key Invert Luma	Inactive	
Shaped	Inactive	
Video		
Manager Size	0	
Streaming Size	0	
Pipeline Size	8	
Texturemanager Size	8	
Video Delay DVE	1	
Video Delay Texture	1	
Repeat Mode	Field	
3G Level B	Inactive	
VBI		
VBI	Inactive	
Delay DVE	0	
Delay Texture	0	
Audio		
Audio	Active	
Channels	2_channels	
Delay DVE	1	
Delay Texture	1	
IP		
Source IP Address		
Source UDP Port	0	

- **Map to VizChannel:** Set which video in channel is mapped onto this Matrox video in channel. The drop-down gives a choice between the available channels. Only the channels not already taken are shown.
 - **Unused:** Do not use this Matrox channel for video input
 - **Video <1 to 8>:** Captured input is available in Video1.

ProcAmp Properties

- **Brightness:** Sets the relative offset on the luminance component of the incoming video (min./max. values are dynamic and determined by the hardware). Default value is 0 (Off).
- **Lumagain:** Sets the gain on the luminance component of the incoming video (min./max. values are dynamic and determined by the hardware). Default value is 0 (Off).
- **Hue:** Sets the color shift on the chrominance component of the incoming video (min./max. values are dynamic and determined by the hardware). Default value is 0 (Off).
- **Saturation:** Sets the gain on the chrominance component of the incoming video (min./max. values are dynamic and determined by the hardware). Default value is 1 (On).

Fill Properties

- **Allow Super Black:** Determines whether or not to clip an output video signal that is under 7.5 IRE units. Default mode is *Inactive*.
- **Allow Super White:** Determines whether or not to clip an output video signal that is over 100 IRE units. Default mode is *Inactive*.
The colorimetry tables for SD (ITUR-BT 601) and HD (ITUR-BT 709) define a color conversion from YUV with the range of 16-235 to RGB with the range of 0-255. Values above 235 are Super White and values below 16 are Super Black. As Super White and Super Black pixels are outside the range of 1-byte RGB, these pixels will be clamped to the normal 16-235 YUV range when used in a texture.
- **Allow Chroma Clipping:** Determines whether or not to clip over-saturated chroma levels in the active portion of the output video signal. Default mode is *Inactive*.

Key

- **Contains Alpha:** Enables/disables playback of clips with alpha.
- **Key Apply Offset:**
- **Key Upscale Luma:**
- **Key Invert Luma:**
- **Shaped:** Defines whether the fill from this channel, when the channel is used in DVE mode, should be interpreted as shaped video during DVE compositing. Default value is *Inactive*.

Video

- **Manager Size:**
- **Streaming Size:**
- **Pipeline Size:** Defines the size of the input queue. Default value is 8.

- **Texturemanager size:** Pre-allocated texture buffer size, in frames.
- **Video Delay DVE:** DVE video delay when used as DVE.
- **Video Delay Texture:** Texture video Delay when used as Texture.
- **Repeat Mode:** Determines the behavior of the IP stream input in case of capture drops. Options:
 - **None:** Does not repeat. Input goes black.
 - **Field:** Repeats the last field.
- **3G Level B:** Activates Level B for 3G mode in 1080p50/60/60M. Default mode is Level A.

VBI

- **VBI:** Defines whether VBI should be used for this channel. Default mode is Inactive.
- **Start Line:** Defines at which line on the input the VBI section will start. Default value is 0 (Off).
The minimum VBI values are (as for VideoOut):
 - **NTSC:** 7
 - **PAL:** 6
 - **720p:** 7
 - **1080i:** 6
- **Delay DVE:** Sets the number of frames VBI should be delayed, before the IP stream can be used, in DVE mode. Default value is 0 (Off).
- **Delay Texture:** Sets the number of frames VBI should be delayed, before the IP stream can be used, in texture mode. Default value is 1

Audio

- **Audio:** When activated, this setting enables audio for this channel. When inactive, audio is disabled. Default value is Activate.
 - **Channels:** Sets the number of audio channels to capture (see also Audio in Viz).
Default number of channels are 2. Available channel options for AES on X.mio are:
 - None, 1, 2, and 4.
 For AES on X.mio2/X.mio2 Plus and for Embedded the channel options are:
 - None, 1, 2, 4, 8, and 16.
- **Delay DVE:** Sets the number of frames the audio clip should be delayed in DVE mode before it can be mixed to the output. Default value is 4.
- **Delay Texture:** Sets the number of frames the audio clip should be delayed in texture mode before it can be mixed to the output. Default value is 4.

IP

- **Source IP Address:** Sets the IP address of the source. Must be an IP in the multicast address range, such as 224.10.10.31 or 239.10.10.51.
- **Source UDP Port:** Sets the port of the source.

Shared Memory

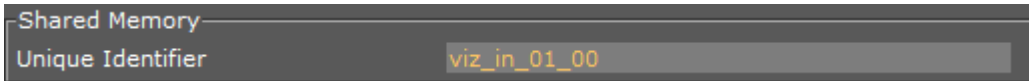

- **Unique Identifier:** Change the name of the Shared Memory, if required. Not available on systems with [Matrox X.mio3 IP](#) video boards.

5.30 Video Output

Use the Video Output section to configure special settings for video output, such as SPG settings and so on.

.....
Note: The VGA version of Viz Engine does not have this section.
.....

5.30.1 Video Output Properties (1)

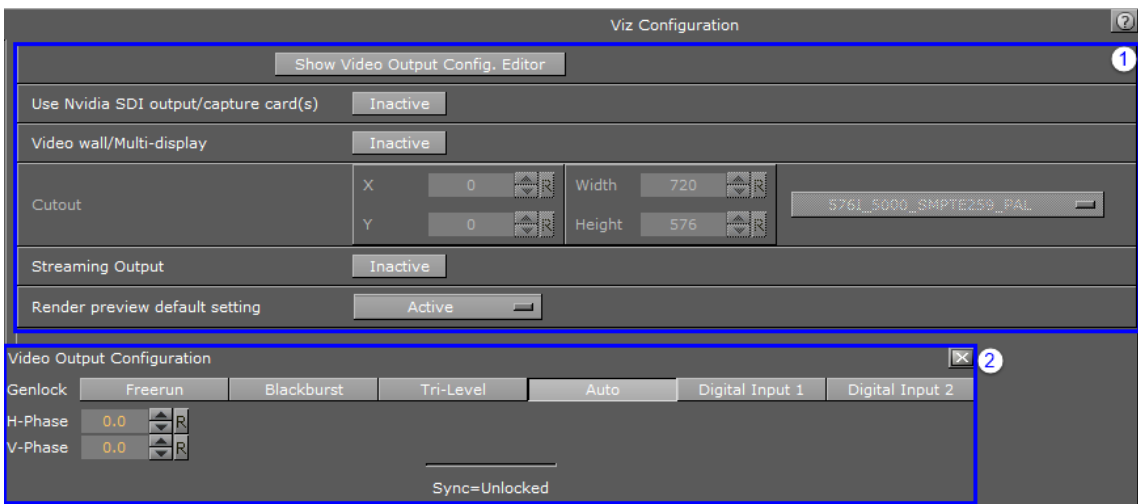

- **Show Video Output Config. Editor:** Opens the Video Output Editor (2). You can also open the Video Output Editor by pressing **Alt+V**.
- **Use NVIDIA SDI output/capture card(s):** Enable the NVIDIA card SDI module to output video. This shortens the output delay when outputting graphics and video through the video board. Enabling this disables the **Video wall/Multi-display** option below.

.....
Note: NVIDIA Output cards with firmware 3.10 or later support embedded audio.
Configurations with older firmware must handle audio externally.
.....

- **Video wall/Multi-display:** Sets the main output to the Digital Visual Interface (DVI). Viz Artist will render to full-screen (set the resolution in [Output Format](#) section). Enabling this disables the **NVIDIA SDI output/capture** option above.
- **Cutout:** Select a section of a video wall and play-out through a Matrox card. Available if **Video wall /Multi-display** is set to **Inactive** and [Output Format](#) is set to **Fullscreen**
 - **X/Y:** Select the position of the cutout.

- **Width/Height:** Set the width and height of the cutout.
- **Resolution** (drop down list): Select one of the supported resolutions for cutout. Please observe that Cutout requires these resolutions to work.

.....
Note: If the Cutout section is disabled, make sure to set the [Output Format](#) to Fullscreen.

- **Allow Super Black** (NVIDIA SDI card only): Controls the key output:
 - **Inactive:** Use the video range (only valid in conjunction with NVIDIA SDI and driver versions older than 259.12).
 - **Active:** Use the full signal range. When active it will determine to clip or not to clip the key output video signal that is under 7.5 IRE units or over 100 IRE units.
- **Readback Async:** Enables asynchronous transfer between the graphics card and DVS Centaurus II video card on systems without a DSX LE preview card.
- **Streaming Output:** Activate or deactivate IP Streaming output.
- **Render preview default setting:** Sets the default value for the Preview button (see [Control Buttons](#)) when Viz Engine is in On Air mode.
 - **Inactive:** Renders only video out signals. This increases performance, as the renderer does not have to render into an editor on-screen and into pixel buffer.
 - **Active:** Rendering will be done for both video out signals and on-screen (this will decrease the performance).
 - **Fullscreen:** Set the On Air window to screen size.

5.30.2 Video Output Editor

The Video Output Editor defines the synchronization standard and the output signal phases.

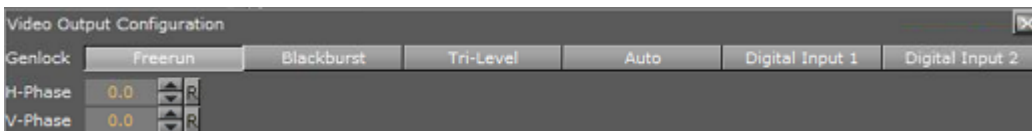

- **Freerun:** Locks Viz Engine to a clock signal on the video board.
- **Blackburst:** Locks Viz Engine to a Blackburst GenLock signal.
- **Tri-level:** Locks Viz Engine to a Tri-Level GenLock signal.
- **Auto:** Auto detects the genlock signal and locks to it.
- **Digital Input 1 and 2:** Locks Viz Engine to the signal on Input 1 or 2.
- **H-Phase and V-Phase:** Shifts the output signal with respect to the sync signal.

.....
Note: The *Auto* option is only available on Matrox boards and on NVIDIA SDI option. On Matrox boards the h- and v-phase settings are updated as well.

To Make the V- and H-Phase Values Coincide

1. Set the **V-phase value**
 - The *V-granularity* is taken from the genlock
 - The *V-delay* is calculated from $V-phase * V-granularity$
 - The genlock is set with this *V-delay*

2. Set the **H-phase value**. Note that there is a distinction whether the H-phase is a positive or a negative value.

a. If the **H-phase > 0**

- The genlock *H-delay* is set to 0
- The *H-granularity* is taken from the video out channel
- The *H-delay* is calculated from $H-phase * H-granularity$
- The fill and key channels are set with this *H-delay*

a. If the **H-phase <=0**

- The fill and key channel *H-delay* is set to 0
- The *H-granularity* is taken from the genlock
- The *H-delay* is calculated from $- H-phase * H-granularity$
- The genlock is set with this *H-delay*

.....
Note: The granularity and possible min/max values are printed to the Viz Artist/Engine console during startup.
.....

It should be taken into account that when the genlock video format is different from the fill /key video format the value of the *V-delay* matches the genlock lines and not the video output lines. The same applies to *negative H-phase* values.

See Also

- [Output Format](#)
- [Video Input](#)

5.31 Video Output: Clip Output

In the Video Output: Clip Output panel, configure the available Clip Channel outputs.

.....
Note: If the Viz Engine being configured is installed as a VGA version, this section is not available in Viz Config.
.....

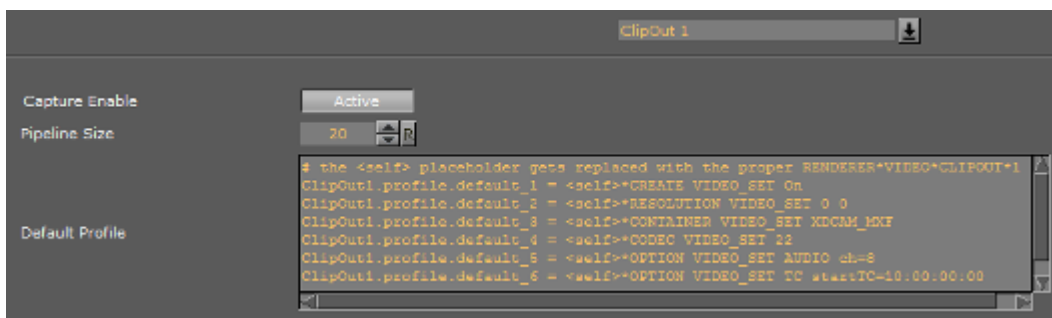

- **Capture Enable:** Enable or disable the clip writer functionality. The main use is to give control over host memory resources. When the clip writer functionality is not needed then the clip out channel does not need to be allocated.
- **Pipeline Size:** Control the number of frames that the clip writer uses to handle a file. It is recommended to leave the default value.

- **Default Profile:** Enter a default profile that can be loaded on request, with the command `RENDERER*VIDEO*CLIPOUT*1*PROFILE APPLY`. Example:

```
# the <self> placeholder gets replaced with the proper
RENDERER*VIDEO*CLIPOUT*1
ClipOut1.profile.default_1 = <self>*CREATE VIDEO_SET On
ClipOut1.profile.default_2 = <self>*RESOLUTION VIDEO_SET 0 0
ClipOut1.profile.default_3 = <self>*CONTAINER VIDEO_SET XDCAM_MXF
ClipOut1.profile.default_4 = <self>*CODEC VIDEO_SET 22
ClipOut1.profile.default_5 = <self>*OPTION VIDEO_SET AUDIO ch=8
ClipOut1.profile.default_6 = <self>*OPTION VIDEO_SET TC
startTC=10:00:00:00
ClipOut1.profile.default_7 = <self>*NAME SET d:/out
/<base_scene2_name>/<clip_name>
```

5.31.1 Placeholders for Variables

Placeholder	Description
<hostname>	Expands to the host name
<if0>	Expands to the IPV4 network address of the first network interface
<if1>	Expands to the IPV4 network address of the second network interface
<if2>	Expands to the IPV4 network address of the third network interface
<absolute_scene_name>	Expands to the complete path of the loaded scene
<absolute_scene2_name>	

5.32 Video Output: SHM Output

Configure Shared Memory Output channels from this panel. The shared memory output is only available on systems with non-IP Matrox video boards, or if **Check Video Card** is set to None in the [Video Board](#) section.

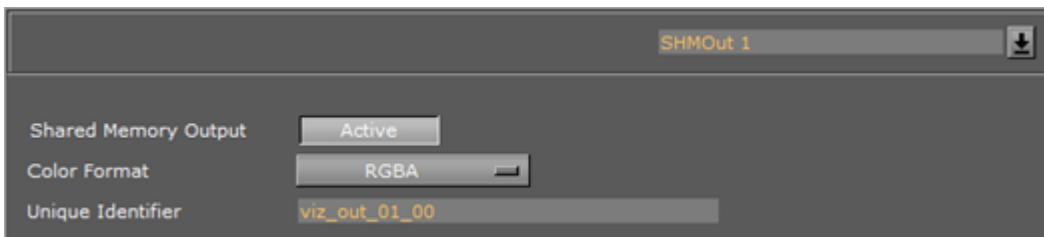

- **Shared Memory Output:** Set the output to Active or Inactive.
- **Color Format:** Displays the active color format for the configured SHM Output.
- **Unique Identifier:** Change the name of the Shared Memory if required. Used when connecting to services such as Viz Coder.

5.33 Viz Artist 2.x

In the Viz Artist 2.x panel, Viz Artist 3 can be switched to Viz Artist 2 mode for compatibility issues.

5.33.1 Viz Artist 2.x

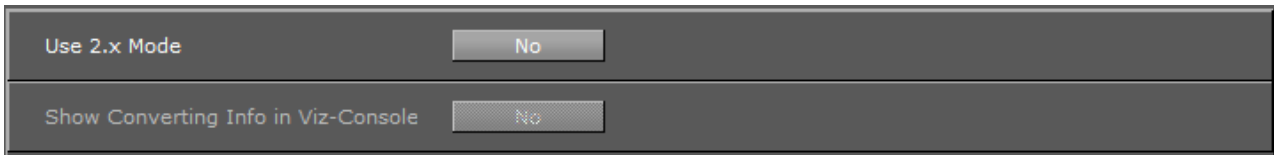

In Viz Artist versions before 3.0, assets were stored in specific subdirectories (Scene, Geometry, Material, Font, and Image). As Viz Artist 3 stores assets anywhere in the directory, older control applications may not find these assets. If enabling 2.x mode, the assets will be looked for in the subdirectories, and calls for scenes will be represented by green lines in the console window.

When working in 2.x mode, *Viz_2x* will automatically be added before the default messaging path.

Furthermore, the paths sent by the external control applications will be converted to lower case (as the names of the data will be converted to lower case when importing). So, external control programs must not be re-written when migrating from Viz Artist 2 to 3.

- **Use 2.x mode:** Enables Viz Engine to run in 2.x mode.
- **Show converting Info in Viz-Console:** Enables the calls for scenes to be shown as green text.

.....
Note: It is only recommended to use 2.x mode if new scenes are organized according to the old 2.x data structure.
.....

5.34 Viz License Information

In the Viz Artist/Engine License Information panel, information about the current Viz Artist/Engine license is shown. The panel lists the various licensed features, for example, the available plug-in packages.

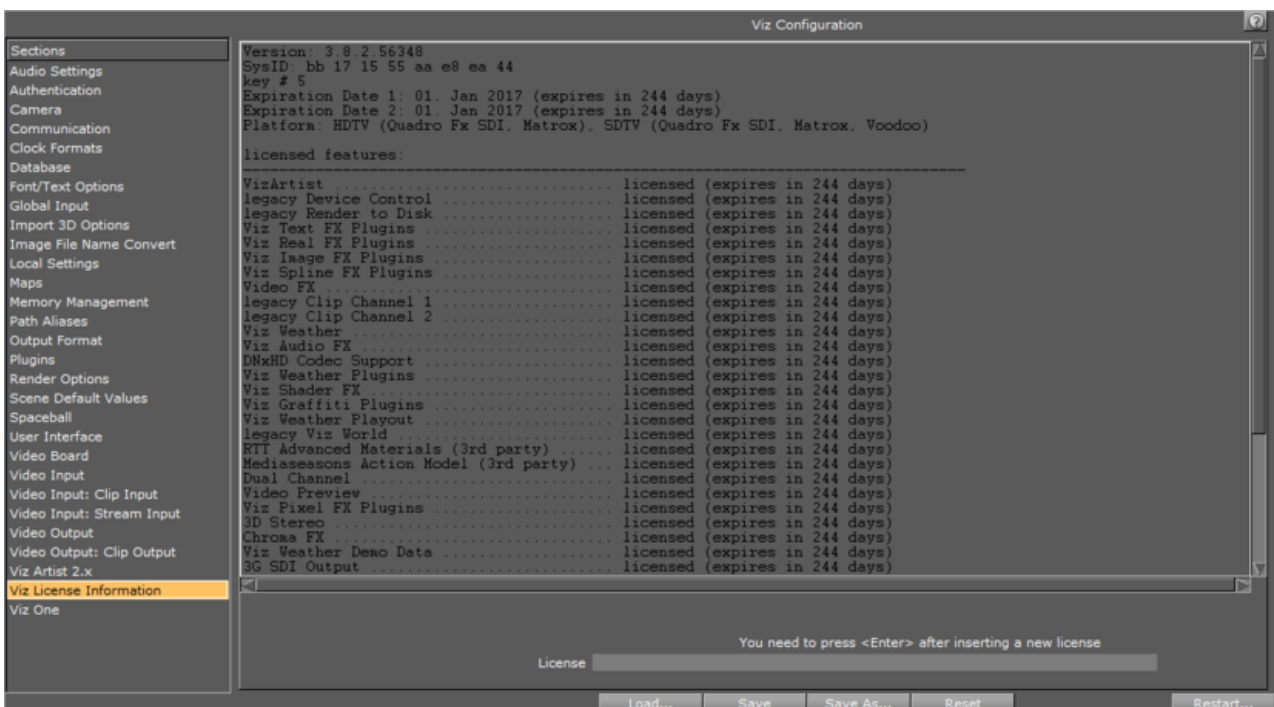

- **License:** Enter a license key into the License field, press <Enter>, and click **Save**. Restart Viz Artist /Engine for the new license key to take effect.

5.35 Viz One

To enable Viz One and Viz Engine to exchange data, two services are required:

- A Viz One File System Monitor (Fsmon) Service (monitors files which are located in the Clip Data directory location (`--root=d:/`))
 - A File Transfer (Mediaftp) Service (transfers files to the Viz Engine)
- Both services are part of the Viz Artist/Engine installation by default, but they must be installed or removed as a service through this panel.

IMPORTANT! If the location of the Clip Data directory is changed after installation, remove and install the two services again. They will automatically set to the new Clip Data Directory (see [Local Settings](#)).

To search, view and select video clips from Viz One, configure the [Viz One Browser](#).

Note: Viz Artist features a *Viz One Transfer Status* pane that shows the progress of any active and finished clip transfers from Viz One. This pane requires the MediaFTP (File Transfer) and Fsmon (File System Monitor) services to be installed and running, and the correct configuration of the Viz One MessageQueue Server.

To use Viz One with Viz Artist, each Viz Artist/Viz One integration must be authenticated through the [Authentication](#) panel in the Viz Configuration. See [Integration with Viz One](#) for the Fsmon and Mediaftp install and remove procedures.

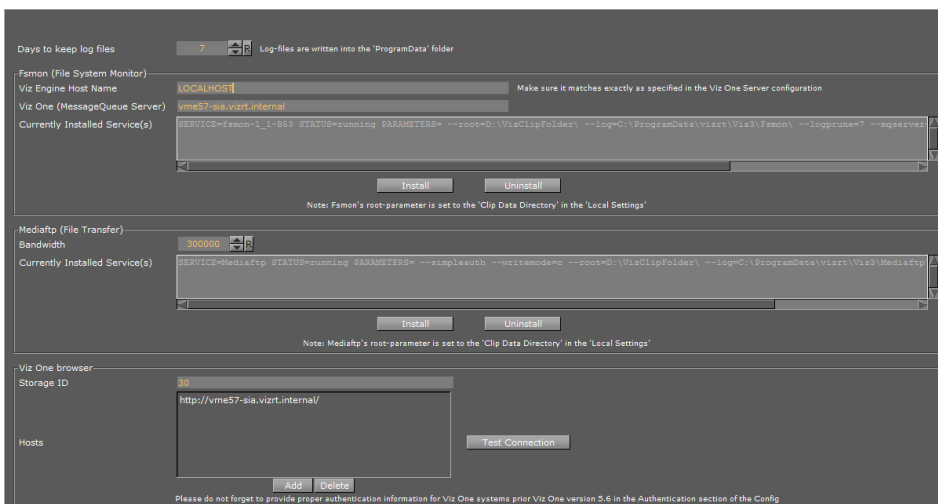

5.35.1 Viz One Properties

This section details the properties of the Viz One configuration panel.

- **Days to keep log files:** Set the number of days to keep log files (default is seven days). Log files older than the set number of days are deleted

Fsmon (File System Monitor)

- **Viz Engine Host Name:** Enter the name of the local host (local host name entered by default). Make sure that the host name is exactly the same as the string specified in the Viz One Server Configuration
- **Viz One (MessageQueue Server):** Host name of the active Message Queue server (do not use a protocol prefix, e.g., http://)

.....
IMPORTANT! To view and transfer files in Viz Artist, the host name entered in the **Viz One (MessageQueue Server)** must also be entered in the [Viz One Browser](#) panel.
.....

- **Currently Installed Service(s):** Shows the currently installed Fsmon service, with its parameters
- **Install/Uninstall:** Install and remove a Fsmon service

.....
Note: Any currently installed service must be removed before a new service can be installed.
.....

Mediaftp (File Transfer)

- **Band Width:** Set the transfer bandwidth, in Kbits per second
- **Currently Installed Service(s):** Shows the currently installed Mediaftp service with its parameters
- **Install/Uninstall:** Install and remove a Mediaftp service

.....
Note: Any currently installed service must be removed before a new service can be installed.
.....

Viz One Browser

This is the configuration for the Viz One Browser in the Media Asset tab (see [Media Asset Properties](#) in the Viz Artist User Guide).

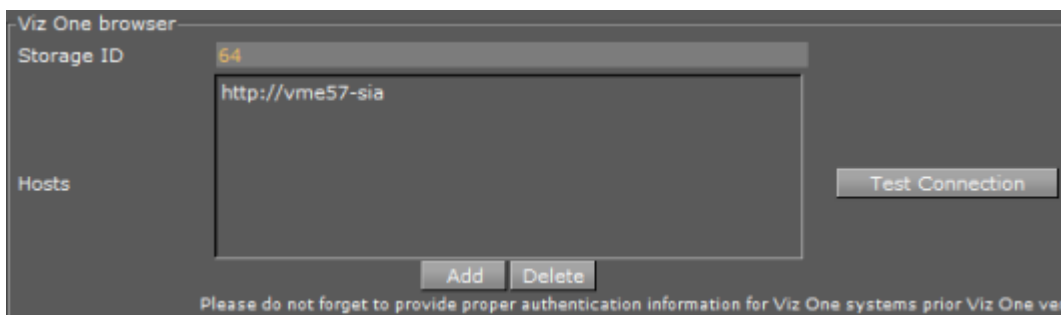

- **Storage ID:** Enter the Storage ID for Viz Artist as configured in Viz One
- **Hosts:** Clicking the **Add** button opens a dialog to provide Viz Engine with the host-name for the desired Viz One instance. The host name must include the protocol prefix, for example: `http://vme57\sia`.
- To remove a previously configured Viz One instance, select it from the list of hosts and click the **Delete** button.
- **Test Connection:** Select the desired host and click the **Test Connection** button to check if the configured Viz One connection is working correctly.

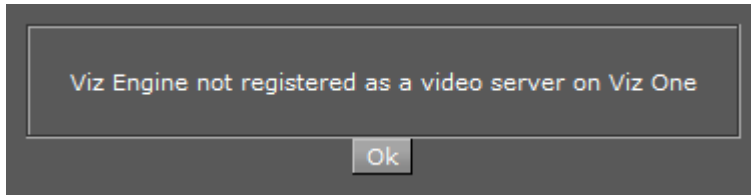

- If Test Connection returns that the Viz Engine is not registered as a Video Server, the Engine must be added as a server in the Viz One Studio Administration. Please refer to the Viz One documentation for further information.

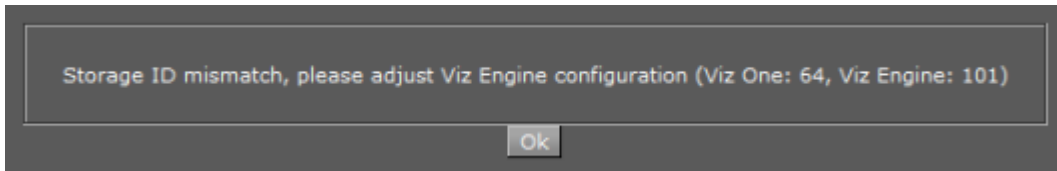

- If Test Connection returns a Storage ID mismatch, please adjust the **Storage ID** field accordingly.

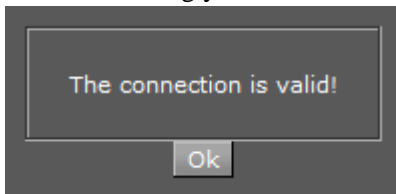

- If Test Connection returns that the connection is valid, the Viz One instance has been configured correctly and is ready for use with Viz Engine.

5.36 Viz Artist/Engine Log Files

All Viz Artist/Engine log files are located in the *<viz data folder>*

.....
Note: This will normally be `C:\ProgramData\Vizrt\viz3`. Check the directory name with the command `echo %programdata%` from a Windows command prompt. This directory is by default hidden in Windows, so to navigate to this directory in Windows Explorer specify the explicit path.
.....

Viz Artist/Engine can provide various log files as documented in the section below.

5.36.1 Viz Render Log

- **Name:** `VizRender_<timestamp>.log`
- **Purpose:** Information on current status of the engine

5.36.2 Viz Trace Log

- **Name:** `VizTrace_<timestamp>.vlog`
- **Purpose:** Command trace that facilitates playback for error reproduction, contains at most the last 500 commands

5.36.3 Viz Gui Log

- **Name:** VizGui .log
- **Purpose:** Information on Viz Gui errors.
- **Log Description:** Each line in the log file will have 6 components or entries, each separated by '|'. A typical log-line will be:

```
Tue Nov 04 10:02:15 EST 2014 | LM_ART | 5420 | Version: 3.7.1.42057 | CONFIG | GPU1
```

The components for each log-line are:

- Date/time
- Type, one of:
 - LM_STARTUP (Regular startup)
 - LM_QUIT (Regular quit)
 - LM_QUIT_TIMEOUT (Timeout quit)
 - LM_QUIT_LOGIN (Login canceled)
 - LM_CFG (Restart with configuration)
 - LM_ENG_GUI (Restart engine with GUI)
 - LM_ENG (Restart engine without GUI)
 - LM_ART (Restart of Artist)
 - LM_ (Current mode restarted)
- Pid (Process id)
- Viz version
- Mode:
 - CONFIG (Config Mode)
 - NOGUI (Engine Mode)
 - NORMAL (Artist Mode)
- Starting on GPU<x>, for example *GPU1* (Graphical Processing Unit no 1)

5.36.4 Viz Shaders Log

- **Name:** VizShaders.log
- **Purpose:** Information on shader compilation

5.36.5 Viz Console Log

- **Name:** Viz_<timestamp>.log
- **Purpose:** Log console output to a file when the engine is started without console (-C option)

5.36.6 Viz Gui Connection Log

This Log is created if 'Write GH Connection Log' is active (see [Local Settings](#)).

- **Name:** VizGuiConnection<timestamp>.log

- **Purpose:** Information on the Graphic Hub Manager database connection

5.36.7 Create Log Files with Log and Clog Commands

The output of the Viz Engine can be redirected to a file using the command `log <filename>`, for example, `log c:\temp\my-engine-log.txt`. Note that the log file will not have content until the Viz Engine in-memory buffers are flushed, meaning written to disk. The log memory buffers are flushed to disk either when the buffer are full or when Viz Engine quits. You can force the buffer to be written to the log file on disk by sending the command: **CONSOLE FLUSH**

You can take an immediate snapshot of the Engine's current in-memory log with the command "**clog**". A new log file will immediately be written to `<viz data folder>\VizRender-ID.log`. The ID in the filename is the GPU ID, making it easy to differentiate log files in a Dual Engine setup for example.

Both the **log** and **clog** commands can be executed by sending them to Viz or by entering them directly in the Engine Console window.

Click on the  button to access the Console window.



6 On Air Mode

The On Air interface may vary, depending on the software and hardware configuration used. In Viz Artist, designers can click the On Air button on the main menu to switch Viz Artist from a modeling tool to a render engine. The application will then wait for control commands; however, scene animations can also be rendered by the use of the [Control Buttons](#) (top-left corner).

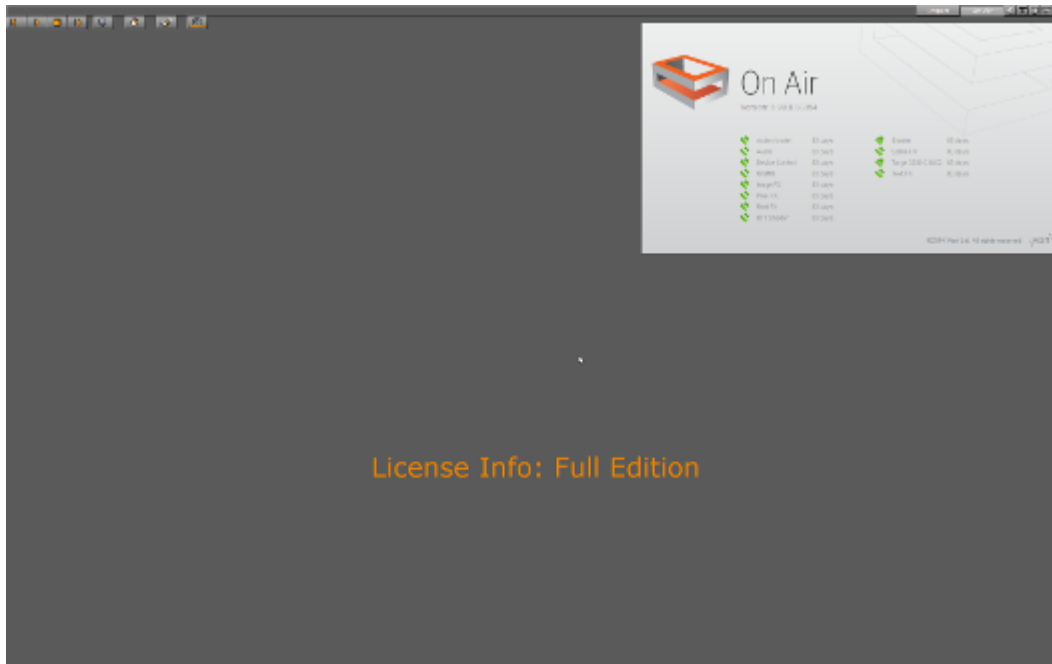

The top left of the On Air screen shows a set of [Control Buttons](#), as well as a [Performance](#) bar button. All [License Information](#) is shown at the top right of the screen.

Depending on the software and hardware settings, additional buttons and information is available. For example in design mode, the scene will be shown in an output window (lower right).

All script events that are added to a scene or to single containers will be executed in On Air mode. To learn more about scripting see the script documentation.

This section contains information on the following topics:

- [Director Control Panel](#)
- [Control Buttons](#)
- [Performance](#)
- [On Air Information Panel](#)
- [License Information](#)

6.1 Director Control Panel

The clapper board button, when in On Air mode, opens the Director Control Panel window.

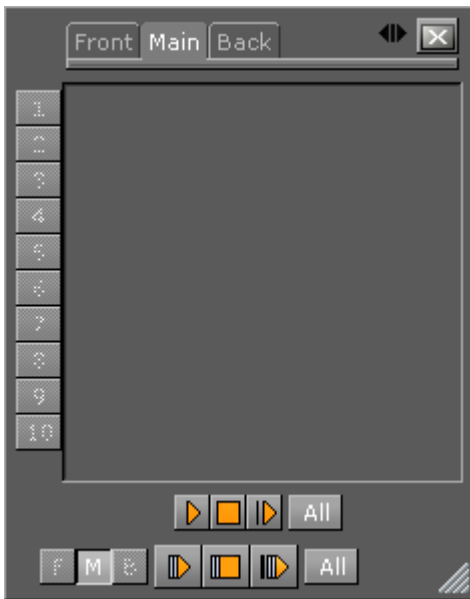





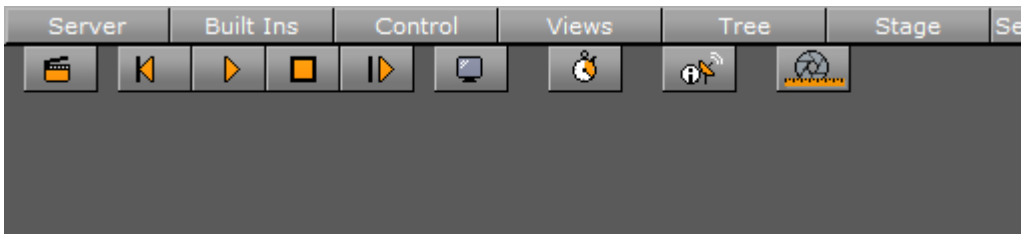

The Director Control Panel window can be used to select and animate one, multiple or all directors in the front, main or back layer. In addition it can be used to set slots and to animate a combination of director (s).

See **Director Control Panel** ([Viz Artist User Guide](#)) for a detailed description of the Director Control Panel.



6.2 Control Buttons

This section contains information on the Controls Buttons, which include the Play and the On Air buttons.



-  **Clapper Board:** Show or hide the [Director Control Panel](#) window
-  **Back:** Jump to the beginning of the animation in the scene
-  **Play:** Start the animation of the scene
-  **Stop:** Stop the animation of the scene
-  **Continue:** Continue the animation after it stopped at a stop point
-  **Render Preview:** Show or hide the VGA Preview window (only available on machines with video cards).

.....
Note: Preview is always enabled on Viz Artist machines without a video card.

-  **Performance Editor:** Show or hide the [Performance Bar](#) .
-  **System Information:** Show or hide the [On Air Information Panel](#) window.
-  **Lens File Editor:** Show or hide the Lens File Calibration Editor. Use to adjust the lens files for virtual studios. Adjust the field of view, lens distortion, mobile point and center shift. It is useful in combination with lens calibration.

6.3 Performance

Analyzing the performance of Viz Artist/Engine can be done with two tools:

- **Performance Bar:** The Performance Bar closely monitors a range of parameters for analyzing real-time performance
- **Performance Analyzer:** The Performance Analyzer monitors key performance and camera parameters, as a head-up display in the renderer window and initiate logging of statistic, command and event information to log files.

This section contains information on the following topics:

- [Performance Analyzer](#)
 - [To open the performance analyzer](#)
- [Performance Bar](#)
 - [To Open the Performance Bar](#)

6.3.1 Performance Analyzer

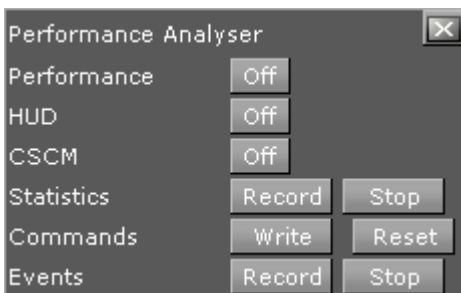

The performance analyzer enables key performance and camera information to be shown in the renderer view as a head-up display. Additionally the performance analyzer can be used to initiate writing of statistic, command and event information to the log files.

- **Performance:** Shows the current (CUR) and (MAX) parameters (see Performance Bar).
- **HUD:** Enables the head-up display (HUD) showing the following parameters in the renderer view:
 - **Camera 1-n:** Show the currently selected camera.
 - **Position:** Show the camera's X, Y and Z position.
 - **Pan/Tilt/Twist:** Show the camera's pan, tilt and twist parameters.
 - **FovX/FovY:** Show the camera's field of view (fov) for the horizontal (X) and vertical (Y) plane.

- **Center Shift:** Show the X and Y position of the camera's center shift.
- **CSCM:** Show the center shift as a cross hair in the renderer.
The Log files can be found in the *<viz data folder>*.

To open the performance analyzer

- Hold Ctrl while clicking the right mouse button on the X (close) button in Viz.

6.3.2 Performance Bar

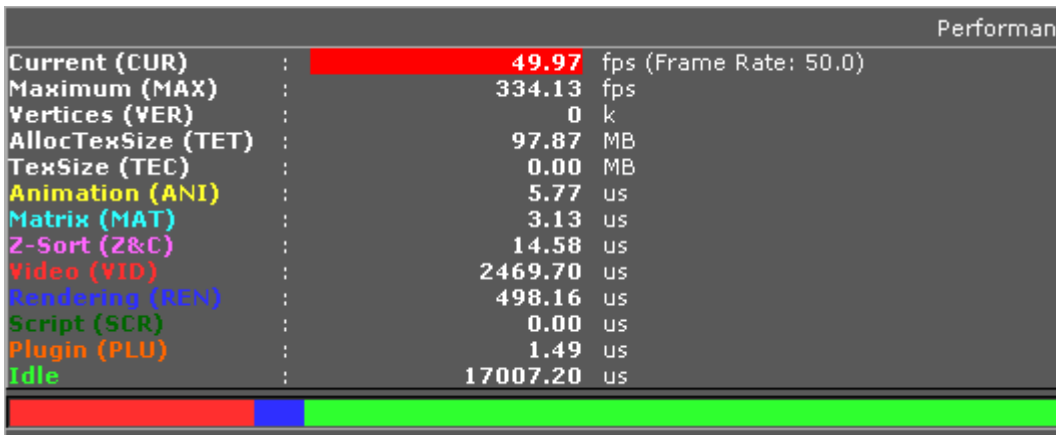

The performance bar gives an idea of the current scene rendering performance (frames per second).

- **Current (CUR):** Shows how many frames per second the scene will render at in On Air mode. The number should be above 50 (PAL) or 60 (NTSC), according to the rate that has been specified in the [Output Format](#) section.
- **Maximum (MAX):** Shows how many frames per second the scene can render at without waiting for vertical retrace. The higher the maximum value, the more performance is left. If the maximum value is reduced to below 50 or 60, the scene is not rendering in real-time.
- **Vertices (VER):** Shows the number of vectors in the scene.
- **AllocTexSize (TET):** Shows the total allocated size of texture memory.
- **TexSize (TEC):** Shows the size of the currently used texture memory.
- **Animation (ANI):** Shows how many microseconds all active directors and animation channels take. This indicator is linked to the yellow bar.
- **Matrix (MAT):** Transforms each container in the scene into world coordinate space. This indicator is linked to the cyan bar.
- **Z-Sort (Z&C):** Refers to Z-sort and Culling, and sorts all containers for correct transparency drawing and determines if containers are visible in the current camera view. This indicator is linked to the pink bar.
- **Video (VID):** Shows how many microseconds video input (live video texture) and video output take. De-interlaced video inputs take longer time than progressive and interlaced. The only way to improve this value is to use a faster system. This indicator is linked to the red bar.
- **Rendering (REN):** Shows how many microseconds it takes to render all objects on the screen. A faster graphics card will improve this value. This indicator is linked to the blue bar.

- Script (SCR): Shows the consumed time in microseconds from all active scripts. This indicator is linked to the dark green bar.
- Plugin (PLU): Indicates how much time in microseconds all active plugins spend in each render cycle. This indicator is linked to the orange bar.
- Idle: Shows available resources in microseconds the renderer has available. This indicator is linked to the light green bar.

To Open the Performance Bar

1. Click the performance bar button .
2. To see all parameters, extend the view by clicking the Eject button.

6.4 On Air Information Panel

The On Air Information panel shows the required parameters to send external control commands and all connected clients, with the IP address, host name and Viz Port.

.....
Note: Polling for On Air information can decrease the performance. For information on how to adjust the On Air Update Interval see the [User Interface](#) section.

This section contains the following topics:

- [Basic Tab](#)
- [Clients Tab](#)

6.4.1 Basic Tab

In the Basic tab, the parameters required to send external control commands are shown:

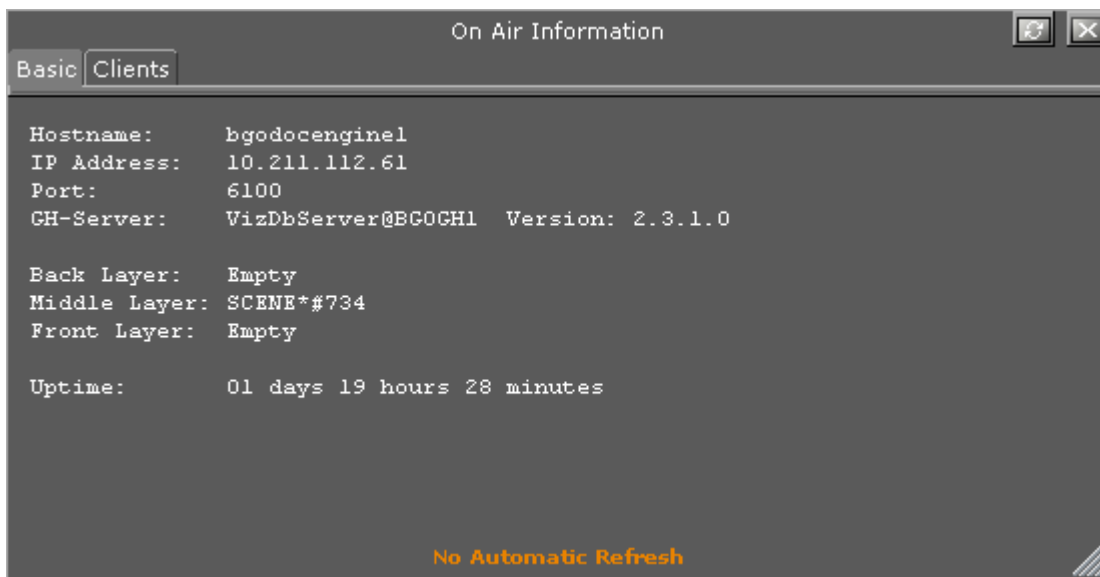

- **Refresh button:** Refreshes the status information.
- **Hostname:** Shows the name external control programs can use to communicate with Viz Artist.
- **IP Address:** Shows the IP address external control commands can communicate with Viz Artist.

- **Port:** Shows the port Viz Artist is using. Default port is 6100, but may be changed in Viz Config's [Communication](#) section.
- **GH-Server:** Shows the Graphic Hub Manager server Viz Artist is connected to.
- **Back Layer:** Shows the name of the scene that is defined to run in the background of the middle and front layer scene(s).
- **Middle Layer:** Shows the name of the scene that is defined to run in the middle between the back and front layer scene(s).
- **Front Layer:** Shows the name of the scene that is defined to run in the foreground of the back and middle layer scene(s).
- **Uptime:** Shows the time elapsed since Viz was started.

6.4.2 Clients Tab

In the Clients tab, all connected clients are shown with the IP address, host name and Viz Port.

IP-Adress	Host-Name	Port	Viz-Port
10.211.111.172		55955	External (6100)

External: 1 Isolated: 0 Shared: 0 SharedFixed: 0 Preview: 0
No Automatic Refresh

6.5 License Information



The license information listing shows the license information such as licensed features and how many days the license has left before it must be renewed.

7 Audio in Viz

This section contains the technical description of the Viz Engine audio system, and contains the following information:

- [Overview](#)
- [Device Recognition and Selection](#)
- [Timing Behavior and Delay Settings](#)
- [Channel Setup and Clip Channel Routing](#)
- [Audio Plug-in](#)
- [Clip Formats](#)
- [Speaker Names](#)
- [Matrox Audio](#)

7.1 Overview

There are two ways to capture audio in the Viz Engine, through Matrox or a DirectSound compatible device.

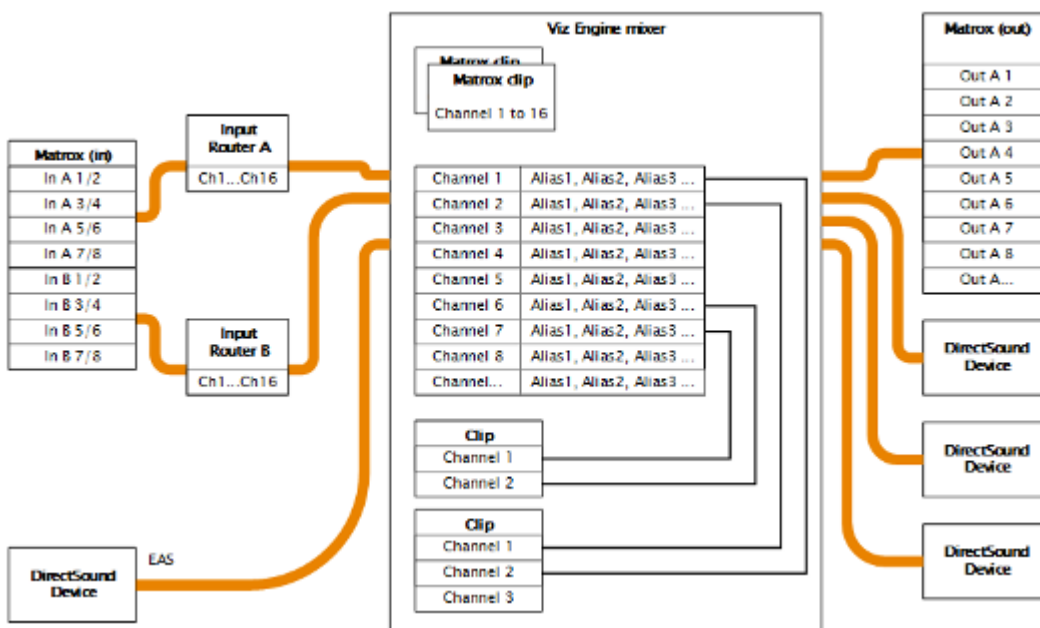

This section contains information on the following topics:

- [Channels](#)
- [Matrox Routing](#)
- [DirectShow](#)

7.1.1 Channels

This section contains the following topics:

- [Audio Channels](#)
- [Matrox Input Channels](#)
- [Output Channels](#)

Audio Channels

Viz Engine handles up to 16 audio channels for both input and output. This corresponds to the maximum number of embedded audio channels on an HD-SDI video source. Every channel can be given one or more user-defined aliases.

Matrox Input Channels

If using Matrox video hardware, the 16 input channels are available as AES/EBU input or embedded audio.

Output Channels

After mixing, the Viz Engine writes the audio data to the available output devices.

7.1.2 Matrox Routing

This section contains the following topics:

- [Matrox Live Input Routing](#)
- [Matrox Clip Routing](#)

Matrox Live Input Routing

On Matrox cards, it is possible to route live input channels to any internal Viz Engine output channel. Several channels can be routed to a single internal channel, but it is not possible to duplicate input channels.

Matrox Clip Routing

Audio from Matrox clips are mapped one by one to the internal Viz Engine channels; hence, no routing is possible.

Audio from audio clips played through the stage is routed to the internal audio channel. This can be done automatic or manually.

See Also

- [Channel Setup and Clip Channel Routing](#)

7.1.3 DirectShow

This section contains the following topics:

- [DirectShow Filters](#)
- [DirectSound Input](#)
- [DirectSound Audio Card](#)

DirectShow Filters

Viz Engine is able to play any audio file for which a DirectShow filter is installed.

DirectShow provides a set of default filters that install automatically with Microsoft® Windows®. These filters support many data formats while providing a high degree of hardware independence.

All the filters supported by the DirectShow Software Development Kit (SDK) are listed on the Microsoft Developer Network (MSDN) website. If a filter appears in GraphEdit but is not documented by the MSDN on-line reference, it means the filter has either been installed by a third party or is used internally by some other Microsoft technology. Such filters are not supported by the DirectShow SDK.

DirectSound Input

Microsoft DirectSound provides a system to capture sounds from input devices and play sounds through various playback devices using advanced 3-dimensional positioning effects, and filters for echo, distortion, reverberation, and other effects.

A DirectSound compatible card is an alternative for designers that use laptops with no video card installed, or if analog audio is needed.

Viz supports DirectSound compatible cards that support DirectX version 8 or later.

.....
Note: Matrox are only able to output digital audio.
.....

DirectSound Audio Card

Viz Engine 3 is able to use any DirectSound capable audio card installed in the system. If a Matrox board is installed on the system, Viz Engine synchronizes the audio output of the DirectSound cards to the video sync signal coming in to the video card.

See Also

- [Device Recognition and Selection](#)

7.2 Device Recognition and Selection

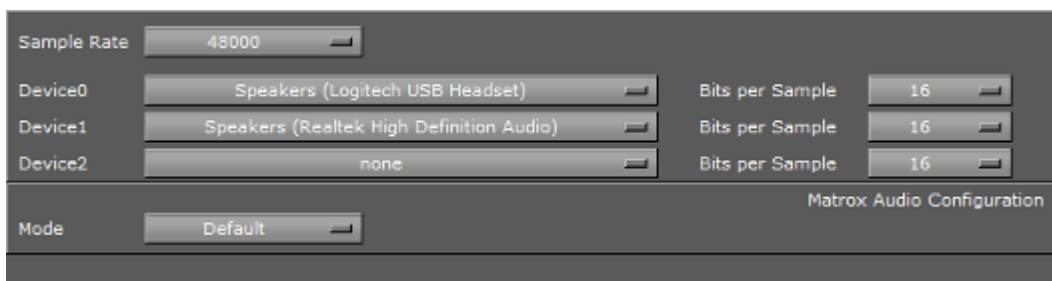

The audio system is able to use any installed DirectSound capable audio device. On every device, up to 16 channels can be used.

- **Sample Rate:** *Reserved for later use.* Shows the sample rate. Default sample rate is 48kHz (48000) which is the maximum allowed.
 - **Device *n*:** Shows the name of the audio card.
 - **Bits per Sample:** *Reserved for later use.* Shows the number of bits used per sample. Default value is 16 Bit per sample rate.
 - **Mode:** Refers to the audio mode of the Matrox board. Options are:
 - **Embedded:** Audio is captured from the Live video input connectors and made available to the Viz Engine audio mixer, to mix it with other audio sources. Then output as embedded audio on the live video output connectors
 - **AES:** Audio is captured from the AES input connectors and made available to the Viz Engine audio mixer, to mix it with other audio sources. Then output on the AES output connectors
 - **Embedded -> AES:** Embedded audio is captured from the live video input connectors and made available to the Viz Engine audio mixer, to mix it with other audio sources. Then output on the AES output connectors
 - **AES -> Embedded:** Audio is captured from the AES input connectors and made available to the Viz Engine audio mixer, to mix it with other audio sources. Then output as embedded audio on the live video output connectors
 - **Loop:** Audio is looped through. No audio is mixed
 - **Default:** Audio is captured, but no output on the Matrox card
- During the startup process Viz Engine tests all available audio cards installed on the system. Manual activation of audio devices is done in **SECTION AUDIO_CONFIG** of the Viz Config file. By default a one to one channel assignment from the first audio device is done when a new device is selected.

7.3 Timing Behavior and Delay Settings

In this timing behavior for every activated DirectSound only card can be set. The default values should work for most devices; however, differences may occur.

7.3.1 Latency adjustment on the DirectSound audio device

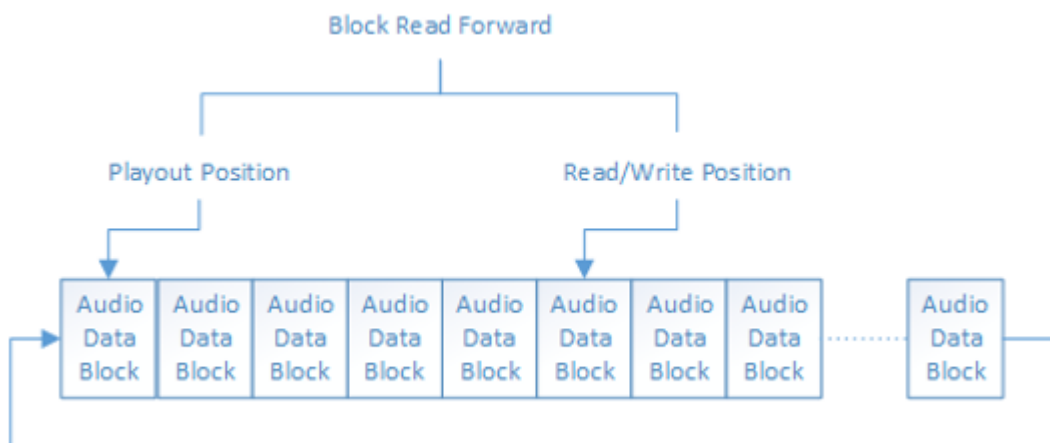

All sound devices use a Ring buffer that stores data until it is sent out to the audio channels, and this ring buffer is organized in blocks of data. All sound hardware defines a distance in blocks (or bytes) that needs

to be maintained. For almost all devices on the market a distance of 6 blocks is sufficient to have a “clean output” without artifacts.

Tip: Try to decrease the 'Block Read Forward' value down to 3 to accomplish less delay for the output. Viz Engine creates a ring buffer of 1 second which is split in 60 blocks. This gives an output delay of 10 milliseconds when the *BlockReadForward* value is 6 (see the Viz Config file's SECTION AUDIO_CONFIG).

Note: An audio card which is not synchronized will always run faster or than a synchronized video or audio card. There is a mechanism needed to keep all audio cards synchronized with each other. The mechanism, shown below, is used by Viz Engine to fulfill this condition:

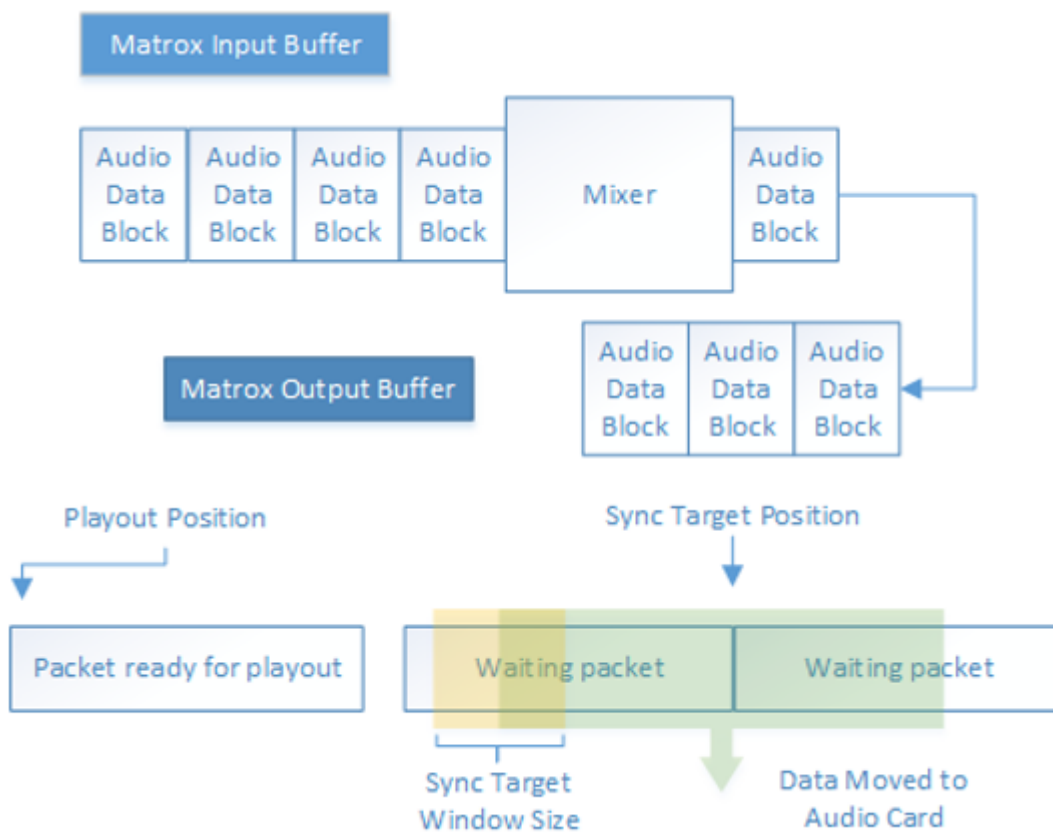

After mixing the packages received from the Matrox board the blocks of audio data are moved to the Matrox output buffer. This buffer is organized as a ring buffer and holds one second of data and this is the maximum delay that can be achieved with the described mechanism.

The `SyncTargetPosition` parameter, set in SECTION AUDIO_CONFIG, defines the position relative to the playout position of the Matrox board where the audio data for the direct sound cards are branched. If the card is running slower than the reference card, the synchronized position will move away from the playout position. If it is faster, `SyncTargetPosition` will move to the playout position. The

SyncTargetWindowSize parameter defines the border, when Viz Engine starts to re-sample the DirectSound data to bring SyncTargetPosition back in place. The predefined value of 250 samples is a good compromise between performance and quality. If a cheap audio card is used and small artifacts can be heard, try to increase this value. Good ranges are from 250 up to 600.

SyncTargetPosition is used to synchronize the different audio cards to each other. Every audio card shows a specific delay behavior. Increase or decrease this value if one card is faster than the other. If the value is too small artifacts will occur; however, most audio cards work fine with the predefined values. SyncTargetPosition and SyncTargetWindowsSize are configurable settings that can be set separately for every activated audio card.

Channel Device and Channel Track settings

In Viz Engine it is possible to combine two or more devices for playout of the Viz Engine's internal audio channels.

Note that Viz Engine internally can use up to 16 channels. On many professional multichannel cards the channels are organized in virtual devices with 2 channels. A good example is the following configuration:

```
Available2 = M-Audio Delta 66 1+2  
Available3 = M-Audio Delta 66 3+4
```

In Viz Engine it is possible to combine these two devices and create a quad speaker configuration as shown below:

```
VIZChannelDevice0 = M-Audio Delta 66 1+2  
VIZChannelDevice1 = M-Audio Delta 66 1+2  
VIZChannelDevice2 = M-Audio Delta 66 3+4  
VIZChannelDevice3 = M-Audio Delta 66 3+4  
VIZChannelDevice4 = Realtek HD Audio output  
VIZChannelDevice5 = Realtek HD Audio output  
VIZChannelDevice6 = Realtek HD Audio output  
VIZChannelDevice7 = Realtek HD Audio output  
VIZChannelDevice8 = none  
VIZChannelDevice9 = none  
VIZChannelDevice10 = none  
VIZChannelDevice11 = none  
VIZChannelDevice12 = none  
VIZChannelDevice13 = none  
VIZChannelDevice14 = none  
VIZChannelDevice15 = none  
VIZChannelTrack0 = 0  
VIZChannelTrack1 = 1  
VIZChannelTrack2 = 0  
VIZChannelTrack3 = 1  
VIZChannelTrack4 = 4  
VIZChannelTrack5 = 5  
VIZChannelTrack6 = 6  
VIZChannelTrack7 = 7  
VIZChannelTrack8 = 0  
VIZChannelTrack9 = 0
```

```
VIZChannelTrack10 = 0
VIZChannelTrack11 = 0
VIZChannelTrack12 = 0
VIZChannelTrack13 = 0
VIZChannelTrack14 = 0
VIZChannelTrack15 = 0
```

See also the Viz Config file, **SECTION AUDIO_CONFIG**.

7.4 Channel Setup and Clip Channel Routing

Channel setup is configured in the [Audio Settings](#) section in Viz Configuration. To get a correct mixing of clip channels to the Viz Engine internal channels it is important to set the audio channels in a correct way.

The [Audio Settings](#) section of Viz Configuration is used to configure audio channels and channel routing, and [To Add Multi-language Audio Channels](#). The latter allows the same scene with the same audio clips to output English, German, French and background music on three different machines. It is also possible to create 3D and other channel configurations for as many environments as needed. Stereo is configured by default.

From Viz Artist, a scene designer is able [To Add Multiple Audio Channel Configurations](#), test the audio channel setup, and switch between the different local setups matching for example one or several remote Viz Engine audio setups. Configurations can also be tested separately or all together.

7.4.1 To Test Audio Channel Setup

1. Start Viz Artist.
2. Create a new Scene.
3. Add a group container to the Scene Tree.
4. Add the [Audio Plug-in](#) .
5. Open the Audio plug-in editor.
6. Add an audio clip to the *Test Clip* drop-zone
7. Click **Play**.

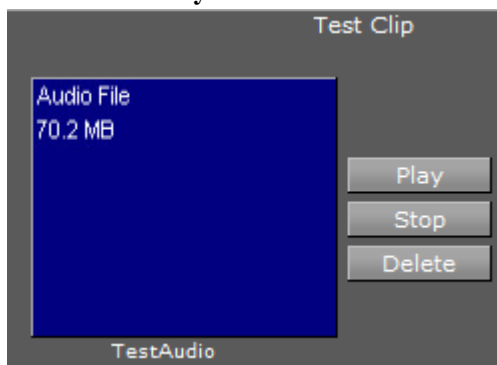

.....
Tip: Always have a set of test clips that will provide audio for the different channel setups.
.....

7.5 Audio Plug-in

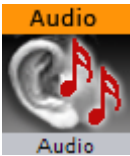

The Audio plug-in allows a designer to configure audio channels.

Go to **Audio** in [Container Plugins](#) (see the [Viz Artist User Guide](#)), for more information on the Audio Plug-in.

This plug-in is located in Viz Artist (*Built-ins -> Container Plugins -> Global*) and can be applied to any container.

7.6 Clip Formats

The recommended audio format is WAVE, as it gives the least decoding time and the best performance. Additionally, it is the only format that matches the Viz Engine support for 16 channels.

Video clips can have interleaved audio in it. The format is limited to 24bit and 48khz. There needs to be at least 2 channels in it as mono is not supported. Again, the maximum channels are 16.

SDI in, break-out box (BOB) out is supported as well as BOB in and SDI out. It can be controlled by the video/clip channels controls.

Viz Engine is able to import and play the following Formats:

- WAVE: Up to 96kHz, 24Bit and 16 Channels.
- MP3: All Formats (Stereo only)
- OggVorbis: All Formats, up to 16 Channels.

See Also

- [Audio Settings](#)
- [Matrox](#) configuration

7.7 Speaker Names

Viz Engine understands the following default speaker names:

- FRONT_LEFT, FRONT_RIGHT and FRONT_CENTER
- LOW_FREQUENCY
- BACK_LEFT, BACK_RIGHT, and BACK_CENTER
- FRONT_LEFT_OF_CENTER and FRONT_RIGHT_OF_CENTER
- SIDE_LEFT and SIDE_RIGHT
- TOP_CENTER, TOP_FRONT_LEFT, TOP_FRONT_CENTER, TOP_FRONT_RIGHT, TOP_BACK_LEFT, TOP_BACK_CENTER and TOP_BACK_RIGHT
- SPEAKER_RESERVED

See Also

- [Audio Settings](#)
- [Matrox](#) configuration interface

7.8 Matrox Audio

The Matrox card is able to up to 16 channels for capture and playout. The audio can be embedded into the video signal or be an external signal through the AES/EBU connectors. It depends on the Matrox version which AES/EBU connectors are available.

On the X.mio cards there are balanced 75 Ohm connectors. On newer cards, 110 Ohm connectors are used.

7.8.1 To Enable Matrox Audio

1. Open **Viz Config**.
2. Click on [Audio Settings](#) .
3. In the **Various** tab, set either, or both, **Enable embedded audio on Live1** or **Enable embedded audio on Live2** to **On**.
 - This must be done for AES/EBU audio as well.
4. Click on the **Setup** tab.
5. Set a **Mode**. Select from:
 - Embedded
 - AES
 - Embedded AES
 - AES Embedded
 - Loop
6. Click on **Matrox**.
7. Select **VideoIn A** or **VideoIn B**
8. In the **Audio** section:
 - Set **Audio** to **Active**
 - Set the required **Channels**
 - Set the required **Delay**

.....
Tip: Use the provided configuration templates to set defined parameters in the **Audio** section. Go to <viz install folder> -> import -> AE -> templates

9. Click **Save**.
10. Close **Viz Config**.

7.9 Emergency Alert System

The Emergency Alert System (EAS) is a national warning system in the United States that supersedes the Emergency Broadcast System (EBS) and the CONELRAD System. EAS is jointly coordinated by the Federal Communications Commission (FCC), Federal Emergency Management Agency (FEMA), and the National Weather Service (NWS). The official EAS is designed to enable the President of the United States to speak to the citizens of the United States within 10 minutes.

In Viz Engine, the analog audio input through the DirectSound device is reserved for the Emergency Alert System (EAS) for broadcasters in the United States of America. If the EAS is activated, all audio will be muted, and the source from the first analog audio card installed in the system will be played through the [Matrox](#) board. The behavior is supported with the Text-to-Speech plugin, as well as audio clips which are recorded prior to sending. These clips can be added dynamically. Viz Engine will then add them directly into predefined audio channels and also mute the other channels.

7.9.1 To specify output channels for EAS

1. Open [Audio Settings](#) and select the **Channels** tab.
2. In the **Out Channel** list, enter the keywords `EAS0` and `EAS1` for the left and right channels, respectively. If either keyword is used in any channel, explicit mapping is used.

Several output channels may be pointed to by the same EAS channel. If no explicit mapping is set, Viz Engine defaults to output channels 0 & 1. Empty mapping is not allowed for the EAS system.

8 Shared Memory (SHM)

The information in this section relates to the [VizCommunication.Map](#) (see the [Viz Artist User Guide](#)).

A local [VizCommunication.Map](#) in each Viz Engine (as part of a cluster), collects and stores data. This data can be internal data, like a scene script pushing data to the map, or data from external control applications through TCP or UDP.

This section contains information on the following topics:

- [External Data Input](#)
- [Internal Data \(Interactive Scene\)](#)
- [Synchronization](#)
- [Snapshot](#)

See Also

- [Data Sharing](#) (see the [Viz Artist User Guide](#))

8.1 External Data Input

Data feed into the Shared Memory (SMM) should be done through the dedicated UDP or TCP IP ports for the SMM. Vizrt provides a set of components, [SendToSMM](#), to makes this task easier.

.....
Note: Go to <Viz Install Directory> -> Tools -> [SendToSMM](#), for more information about [SendToSMM](#).
.....

Data can also be sent to SHM through a Command Interface. Data sent through the Command Interface may be seen as a good option because the data would need to be sent to one Viz Engine only, and this Viz Engine would then distribute the data to the other Viz Engines. But Data sent to SHM through the Command Interface has problems:

- Data sent through the Command Interface will block the render queue of the receiving engine causing potential frame drops. Since the data needs to be sent through a command significant more bytes are transferred over the Network.
 - This Viz Engine is also a single point of failure
 - The data will arrive at this one Viz Engine sooner than on all other Viz Engines
 - The notification method of the Graphic Hub Manager is used to distribute the data and can cause additional load for the Graphic Hub Manager
- The preferred method to send data is to use the 'SendToSMM' library (or an equivalent) to send the data to the individual Viz Engines.

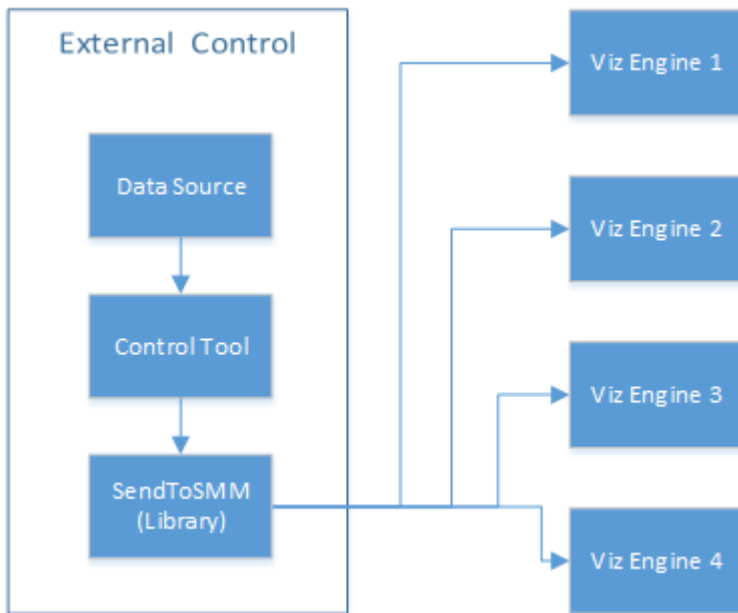

The communication protocol for the import of Shared Memory data depends on the type and final output of the data. There are set protocols to use with large amounts of data, in which all of the data must reach its destination graphic, and also where large amounts of data must be received, quickly, but some loss of data is acceptable.

.....
Note: It is also possible to import data through Multicast. This method is not recommended as it can pollute the network.

This section contains information on the following use-cases:

- [SHM over TCP](#)
 - [To Use TCP for SHM](#)
- [SHM over UDP](#)
 - [To Use UDP for SHM](#)
- [Plugin API](#)
 - [Command Interface](#)
 - [Command Examples](#)

8.1.1 SHM over TCP

The SHM TCP communication protocol guarantees a reliable delivery of packages. It is a much more efficient than the [Command Interface](#), but not as fast as [SHM over UDPI](#).

Use cases for a TCP connection could be finance stocks and currencies, or election result information, where the requirement is to deal with large amounts of information, and all of this data must reach its destination graphic. A single piece of lost data can have economic consequences, falsify charts, show mathematically wrong results, etc.

A TCP connection to a Viz Engine can be held open for a long time (this is recommended), and should not be opened and closed between sending variables.

.....
Note: The default maximum number of TCP connections is limited to 255. Within this number of connections, a user defined limit of maximum connections can be set in the [Communication](#) section of Viz Configuration.
.....

.....
IMPORTANT! The external program which provides the data, must connect and send the data to each Viz Engine individually. Vizrt provides a C# library, SendToSMM (part of the Viz install), for this purpose.
.....

To Use TCP for SHM

The screenshot shows the 'Shared Memory' configuration panel. It has two tabs: 'Global' and 'Shared Memory', with 'Shared Memory' being the active tab. The panel contains several input fields and buttons:

- Multicast Ip Address: 224.2.2.2
- Multicast Port: 0 (with up/down arrows and a refresh button 'R')
- UDP Port: 0 (with up/down arrows and a refresh button 'R')
- TCP Port: 0 (with up/down arrows and a refresh button 'R')
- Debug: Inactive
- Master Engine Ip Address: (empty field)
- Master Engine Port: 0 (with up/down arrows and a refresh button 'R')
- Master Poll: Inactive, Commands, UDP, TCP (radio buttons)

1. Go to the [Configuring Viz](#).
2. Click on [Communication](#).
3. Click on the **Shared Memory Properties** tab.
4. In the Shared Memory panel set these parameters:
 - **TCP Port:** Vizrt does not recommend a specific port. Always make sure that the selected port is not in use by any other program on the same subnet.
5. Click **Save**.

The syntax for the key-value pairs is:

- key|value\0
Multiple key-value pairs can be sent, at once, as well. To do this make sure that each pair is terminated with 0.
- key1|value1\0key2|value2\0key...

8.1.2 SHM over UDP

The SHM UDP communication protocol should be used for the delivery of volatile data. It is quicker than the [SHM over TCP](#) protocol, but less reliable, and is much more efficient than the [Command Interface](#).

A use case for UDP would be Motor Sports, where data like speed, velocity, etc., is required. This is where there is a requirement to deal with large amounts of data, but not all of this data must reach its destination. A single piece of data lost will not affect the constant data update.

To Use UDP for SHM

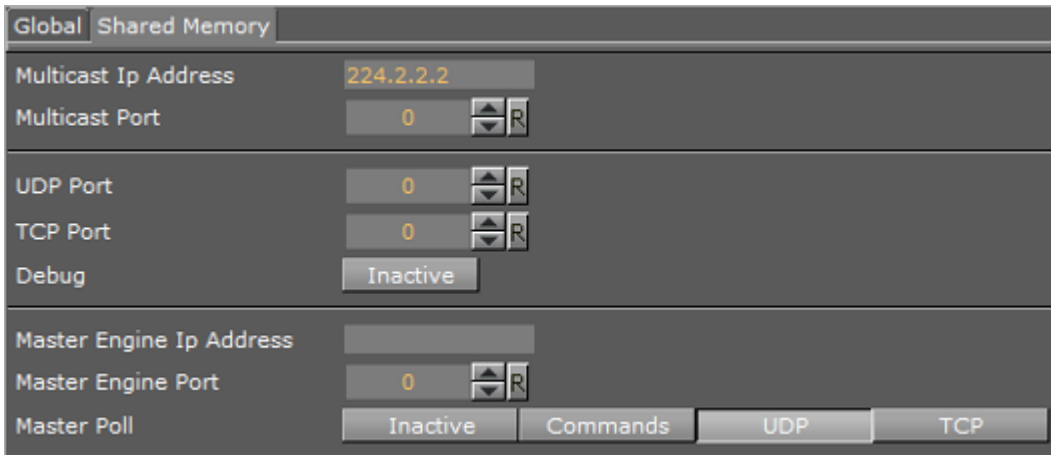

1. Go to the [Configuring Viz](#).
2. Click on [Communication](#).
3. Click on the **Shared Memory Properties** tab.
4. In the Shared Memory panel set these parameters:
 - **UDP Port:** Vizrt does not recommend a specific port. Always make sure that the selected port is not in use by any other program on the same subnet.
5. Click **Save**.

The syntax for sending key-value pairs is the same as for [TCP and UDP Synchronization](#).

8.1.3 Plugin API

An option to manipulate data in SHM is by a plugin interface.

A use case would be where a TCP or UDP connection can not be used, or is not to be used. It is possible to write a plugin to import data (e.g. from an XML file, another database, etc.) and push it to SHM.

Another use case would be an interactive Scene (see [Internal Data \(Interactive Scene\)](#)).

.....
Note: The Plug-in API documentation is included with the Viz installation (go to *Start -> All Programs -> vizrt -> Viz 3.x -> Documentation -> Plugin SDK Documentation -> Classes -> Class List -> Shared_Memory*).

Command Interface

For small and single value changes the Command Interface of Viz Artist can be used. For example, to update a headline in a Scene.

.....
IMPORTANT! A command operation can block the renderer. If there are too many commands, within a small time, or commands containing a large amount of data, are sent, this can result in not rendering real-time anymore.

.....
.....
Note: Vizrt do not recommend this as a method for data import.
.....

Any external program should consider the performance of the single or all connected Viz Engines. If there is a burst of thousands of SHM variables this can have implications on the Viz Engine rendering performance (Current (CUR) and Maximum (MAX)).

A full list of commands is at:

- `<viz install folder>\Documentation\CommandInterface\index.html`

.....
Note: From the list of commands, the commands, CLEAR, DELETE_ELEMENT and PURGE_ELEMENT will only work when sent through the command interface of Viz Artist.
.....

.....
IMPORTANT! The command CLEAR must be run on each Engine where the MAP is to be reset (VIZ_COMMUNICATION*MAP CLEAR).
.....

Whenever a new entry is made in the map (a new key-value pair) or values are changed, then the change is propagated to the other Viz Engines through a database messaging service to update the local copy of each Viz Engine's map (this only works when sent over the general communication port of Viz Engine (default port 6100)).

Command Examples

VIZ_COMMUNICATION*MAP can be used to access the map.

SET_DOUBLE_ELEMENT and GET_DOUBLE_ELEMENT

.....
Example:VIZ_COMMUNICATION*MAP SET_DOUBLE_ELEMENT "my_double" 1.2
.....

.....
Example:VIZ_COMMUNICATION*MAP GET_DOUBLE_ELEMENT "my_double"
.....

8.2 Internal Data (Interactive Scene)

When data is modified on one Viz Engine through a script or through a plugin, the data change will get reflected on the other Viz Engines automatically.

A use case could be a touch screen scene which modifies data, which is also used for HD-SDI Viz Engines or Viz Engines driving a Video Wall.

This synchronization uses the Graphic Hub Manager as a relay. Therefore it is important that all Viz Engines, which are to receive the data, are connected to the same Graphic Hub Manager, which use the same user or at least the same group.

8.3 Synchronization

If a Viz Engine is restarted or added to the cluster of Viz Engines for playout, the VizCommunication.Map data will not be available on this Viz Engine. The local map on a new or restarted Viz Engine can be synchronized with the local map on another running Viz Engine in the same cluster.

.....
Example: If Viz Engine 1 restarts it will look to, for example, Viz Engine 3 to update its local VizCommunication.Map.
.....

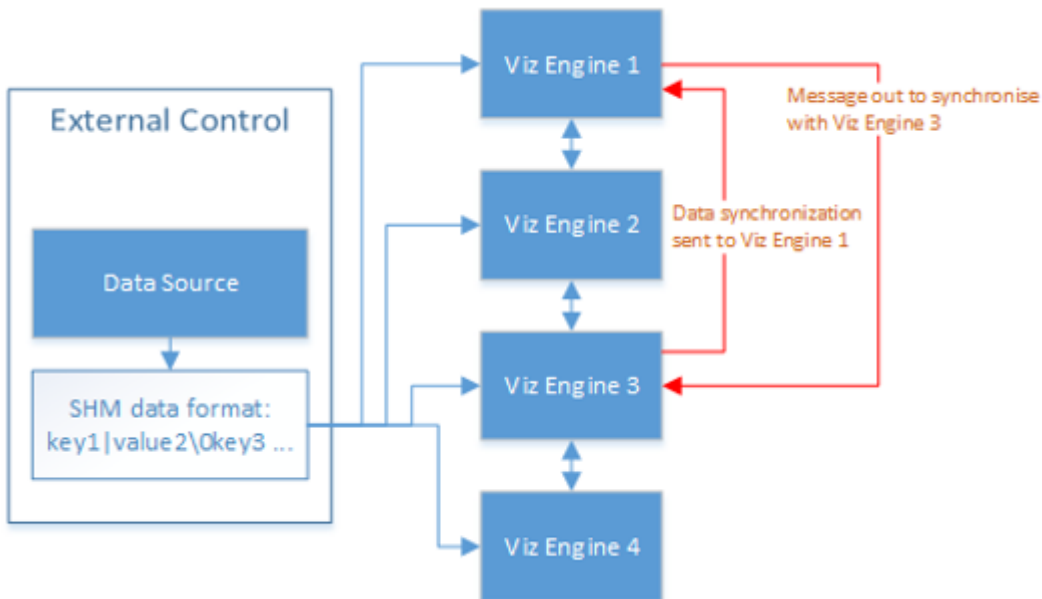

A start-up Viz Engine can be synchronized through:

- TCP, or
- UDP, or
- An External Control Application, or
- Commands

This section contains information on the following topics:

- [TCP and UDP Synchronization](#)
 - [To Synchronize a Viz Engine with TCP or UDP](#)
- [External Control Synchronization](#)
- [Command Synchronization](#)
 - [To synchronize a Start-up Viz Engine with Commands](#)

8.3.1 TCP and UDP Synchronization

Use the procedure detailed below to synchronize a restarted or added Viz Engines, in a cluster, with the TCP or UDP protocol:

- **TCP:** The recommended communication protocol to synchronize maps on start-up because it is reliable and efficient (see [SHM over TCP](#)).
- **UDP:** For fast communication, but has drawbacks. For instance, packets can get lost (see [SHM over UDP](#)).

To Synchronize a Viz Engine with TCP or UDP

1. Go to the [Configuring Viz](#).
2. Click on [Communication](#).
3. Click on the **Shared Memory Properties** tab.
4. Enter the TCP or UDP port number.

.....
 Always make sure that the selected port number is not in use by any other program on the same subnet.

5. In **Master Engine Ip Address** type the Ip address of a running Viz Engine to synchronize with. Example <IP/hostname of Viz Engine 3>.

.....
Note: Must be the IP address of a running Viz Engine in the same cluster system.

6. In **Master Engine Port**, type the port number to be used (default 6100). This port sends the single startup synchronization command to start synchronizing. It should be the same as the general communication port of the Viz Engine set in **Master Engine IP Address**.
7. In **Master Poll**, select **UDP** or **TCP** as selected in step 4.
8. Click **Save**.

8.3.2 External Control Synchronization

Synchronization can also be done from an External Control Application. The following command has to be sent to the Viz Engine which has the memory map populated:

- **From a Command Interface**

```
VIZ_COMMUNICATION SYNCHRONIZE_TO <engine port>
```

where the Viz Engine is the engine which receives the data through the Command Interface. The port is usually 6100 (standard command interface port).

.....
Note: Vizrt do not recommend this as a method for synchronization.
.....

- **Through TCP Communication**

```
VIZ_COMMUNICATION SYNCHRONIZE_SMMTCP <engine port>
```

where the Viz Engine is the engine which receives the data, and the port is the one that was specified for incoming TCP key|value pairs on the Viz Engine which is to receive the data (see [SHM over TCP](#)).

- **Through UDP Communication**

```
VIZ_COMMUNICATION SYNCHRONIZE_UDP <engine port>
```

where the Viz Engine is the engine which receives the data, and the port is the one that was specified for incoming UDP key|value pairs on the Viz Engine which is to receive the data (see [SHM over UDP](#)).

8.3.3 Command Synchronization

Another communication option is by Commands. Here each map entry is synchronized through commands.

It is reliable, but very slow and blocks the engine for quite an amount of time, if the map is large.

.....
Note: Vizrt do not recommend this as a method for synchronization.
.....

To synchronize a Start-up Viz Engine with Commands

1. Go to the [Configuring Viz](#).
2. Click on [Communication](#).
3. Click on the **Shared Memory Properties** tab.
4. In the Shared Memory panel set these parameters:
 - **Master Engine Port:** Enter the communication port of the Master engine (default is 6100).
 - **Master Poll:** Click on **Commands**.
5. Click **Save**.

8.4 Snapshot

It is also possible to take a data ‘snapshot’ (save the whole content of the map) at any time. One Viz Engine can save the whole content of the map by calling the map’s SaveToDb procedure, and another client can read it by calling LoadFromDb.

The downside of this approach is that these functions block the renderer and can cause poor performance of the Graphic Hub Manager database, if the map is stored repeatedly.

.....
IMPORTANT! The resulting SHM map objects are replicated as well. So saving the map each field or every minute can result in serious problems for the Graphic Hub Manager database (replication failing, etc.).
.....

Note: For more information see the script function documentation. Go to, *Start -> All Programs -> vizrt -> Viz 3.x -> Documentation -> Script Documentation -> Data Types and procedures -> Shared Memory*, or *<Viz Install Directory> -> ScriptDoc -> DataTypeSharedMemory*.

See Also

- [External Data Input](#)
- [Synchronization](#)

9 Frame Accurate Output

At the moment the frame accurate commands only work with DVE as clip target. Due to different usage of the ring buffer (another place in the timeline) the texture target is not working.

This section contains information on the following topics:

- [Prerequisites](#)
- [Configure Frame Accurate Output](#)
- [Commands](#)
- [General Purpose I/O Commands](#)

9.1 Prerequisites

To make sure clip handling is fast the system has to be configured to use a RAID-0 hard disc configuration. Also it is best to use a Matrox X.mio2 or X.mio2 Plus rather than an X.mio because of the increased memory usage and performance required.

If the system is fitted with an X.mio you could increase the performance by setting the used RGB to YUV conversion to Shader (see [Render Options](#)). For further details, see the [Configure Frame Accurate Output](#) section.

As all of the clip players are initialized at first usage it is necessary to do so prior to starting a frame accurate scene. Do this by loading a dummy scene that has all clip channels set to either DVE or texture mode and a valid clip name given.

.....
Note: It can take up to four seconds for the clip players to initialize. Do this a second time to also initialize the pending clip players. Please keep in mind that this procedure is only needed after a fresh restart of the Viz Artist/Engine.
.....

9.2 To Configure Frame Accurate Output

1. Open **Viz Configuration**
2. Select the [Communication](#) section and **enable Frame Accurate Viz Communication**
3. Set **FAVC Bias** as needed
 - Delay fields (in addition to ring buffer size) for frame accurate commands via TCP or GPI. This is the bias in frames for the commands if Frame Accurate Viz Command is turned on. Could be negative as well.
4. Set **FAVC Field Dominance** to **Odd Retrace Counter**
 - For FAVC Field Dominance you can set Odd Retrace Counter or Even Retrace Counter where Odd retrace counter is the recommended option.
5. Select the [Render Options](#) section and set the **RGB to YUV** setting to **Shader**
 - The following setting will increase performance only when an X.mio is installed.
6. Select the [Matrox](#) section and click the [Memory Management](#) tab
7. Expand the **ClipIn** settings for the clip channel you use (1 or 2) and set **Video Delay DVE** to **0** and **Pending** to **Active**

8. Click **Save** and **Close**

9.3 Commands

To enable frame accurate handling of clips, it is necessary to preload the next scene by using the CUE command:

```
SCENE*<Scene Name> CUE
```

Because the loading time of clips is affected by disc speed and the used codec, allow at least 1 second head start for the CUE command. The earlier you cue the next scene the more likely all of the clips are prepared when needed.

After the initial CUE command it is/could be necessary to send the following commands. If the scene was saved at another position than 0 send:

```
SCENE*<Scene Name>*STAGE SHOW 0.0
```

The following is always needed to finally set and activate the scene:

```
RENDERER SET_OBJECT SCENE*<Scene Name>
```

If the director is not configured to auto start you should use:

```
MAIN_SCENE*STAGE START
```

.....
Note: The first and last commands are optional
.....

9.4 General Purpose I/O Commands

Viz Engine can send and receive frame accurate commands via General Purpose input/output (GPIO), provided the following requirements are met:

- PCI or PCI Express Sealevel I/O device with 8, 16 or 32 digital inputs installed. Devices connected via Ethernet or USB cannot be used.
- Viz Engine 3.3 (rev 8394) or later to receive commands.
- Viz Engine 3.8.2 to send commands.
- A Matrox X.mio-series video board is required for getting the actual field which is played out.

This section contains information on the following topics:

- [Input Functionality](#)
- [Flow of the GPI signal](#)
- [Output Functionality](#)
- [Commands](#)

9.4.1 Input Functionality

Currently there are five commands available which enables you to queue commands for execution when a pin on the Sealevel board shows a raising or falling edge. For every Pin, an arbitrary amount of commands can be queued for the raising and falling event. Every command can be armed with a counter which tells Viz Engine how often the command should be executed before it is removed from the queue. A counter of 0 tells Viz Engine that the command should never be removed from the queue.

The following diagram illustrates the [Flow of the GPI signal](#) from the sender until the consequences of the executed command are rendered into the correct position in the Matrox ringbuffer. As soon as a **GPI sender** changes the status of a pin, connected to the **Sealevel device**, the change is reflected in an internal register of the card. In Viz Engine a **thread** polls this register every millisecond. As soon as a change is found it calculates the timestamp for when the command should be executed.

The thread looks for the pin command in the **Command map** and queues the command into the **Timestamped commands** queue. As the actual depth of the Matrox ring buffer is known the render loop checks every field if it is time to execute a command from the queue. This guarantees that the command is executed at the correct field, no matter how large or full the ringbuffer actually is.

9.4.3 Output Functionality

Since version 3.8.2, Viz Engine is able to send external triggers via GPIO on systems with a supported Sealevel GPI/O card installed, using the [GPO Command - Set](#).

Depending on the GPI/O card configuration in the Sealevel driver, the first configured output channel could reside in a higher bank. For example, bank 2 -> first channel = 16.

.....
Note: Only one channel can be sent at a time.
.....

9.4.4 Commands

The following are the available GPIO commands:

- [Pin Command - Set](#)
- [Command - Clear](#)
- [Information - Get](#)
- [Pin Command - Test](#)
- [Enable - Set](#)
- [GPO Command - Set](#)

Pin Command - Set

```
VIZ_COMMUNICATION*GPI_PIN_COMMAND SET "<Command ID> <Command>" <PIN>  
<UP_DOWN> <COUNT>
```

Adds a command to the queue.

.....
Example:VIZ_COMMUNICATION*GPI_PIN_COMMAND SET "-1
RENDERER*MAIN_LAYER*STAGE START" 0 1 0
.....

- **<Command ID>**: The command ID specifier.
- **<Command>**: Command string which should be queued.
- **<PIN>**: Input pin number (valid from 0–31) where the first Pin is 0.
- **<UP_DOWN>**: 0 means the command should be executed on a falling edge, 1 means the command should be executed on a raising edge.
- **<COUNT>**: The command will be executed <Count> times. The command will execute once per event and NOT <Count> times per event. A value lower or equal to 0 means that the command will never be removed from the queue.

Remarks: After the GPI event occurs, the execution time of the command will be calculated. The execution time is calculated in the following way:

Ring_Buffer_Size*2+7+Delayed_Command_Bias. The <Delayed_Command_Bias> can be set in the Viz Config file. Therefore Ring_Buffer_Size*2+7 is the minimum delay for GPI triggered commands.

Command - Clear

```
VIZ_COMMUNICATION*GPI_PIN_COMMAND CLEAR <PIN> <UP_DOWN>
```

Clears all commands from the queue.

- **<PIN>**: Input Pin number (valid from 0–31) where the first Pin is 0.
- **<UP_DOWN>**: 0 simulates a command executed on a falling edge, 1 simulates a command executed on a raising edge.

Information - Get

```
VIZ_COMMUNICATION*GPI_INFO GET
```

Sends information on the installed GPI device.

If a valid device is present the command will return the number of available GPI Banks. Therefore a value of 1 means that 1 bank (8 inputs) is available.

If the command returns 0 no valid GPI device is present.

Pin Command - Test

```
VIZ_COMMUNICATION*GPI_PIN_COMMAND TEST <PIN> <UP_DOWN>
```

Sends all queued commands for the pin and signal to the Viz Engine. The counter for the commands is not decremented.

- **<PIN>**: Input Pin number (valid from 0–31) where the first Pin is 0.
- **<UP_DOWN>**: 0 means the command should be executed on a falling edge, 1 means the command should be executed on a raising edge.

Enable - Set

```
GLOBAL*GPI_ENABLE SET <1 or 0>
```

Enables or disables GPI commands for the Viz Engine. All functionality is available except of sending the commands on a GPI signal. If disabled the command will be shown in the console and a warning is shown, that GPI is disabled. The TEST command is working as usual, even if GPI is disabled.

- 1 enables GPI execution
- 0 disables GPI execution

GPO Command - Set

```
VIZ_COMMUNICATION*GPO_BIT SET <bit> <state>
```

Sets the specified output channel to either ON or OFF:

- 1 is ON

- 0 is OFF

The command can be sent directly via the Viz Engine command line, via an action keyframe, or DataPool plug-ins.

.....
Example: send VIZ_COMMUNICATION*GPO_BIT SET 17 1

.....
IMPORTANT! The bit count starts at 0.

9.5 Timed Command Execution

In order to achieve frame accurate output at a certain time, Viz Engine takes advantage of a time code reader board and special commands.

Viz Engine will record certain commands and executes them exactly at the time the time code reader board will hit this timestamp.

Here, you find the following:

- [Time code related commands](#)
- [Prerequisites](#)
- [Configuration](#)
- [Settings for X.mio2 and X.mio2+ boards.](#)

.....
 Field Accurate Timed Command Execution is only available on Matrox X.mio2, X.mio2+ and X.mio3 (as X.mio2+) boards.

9.5.1 Time code related commands

*TC*TC_INFO GET*

Gives you all available time codes in the system. The return is a list of indexes and strings. Therefore every time code source is identified by a unique index.

*TC*TC_ACTIVE GET*

Gives all time codes which have been updated in the last 2 fields

*TC*TC GET <index>*

Returns the time code for the index. *TC*TC_COMMAND SET <index> <HH> <MM> <SS> <FF> "Command String" <Count>*

Queues a Command for execution on a specific Time.

<index> : Index of the Timecode

<HH> <MM> <SS> <FF>: The timecode in Hours,Minutes,Seconds,Fields "Command String": The Command in quotes.

<Count>: The command will be executed Count times. If Count is smaller than 1 the command will be executed always when the time code is read on the source.

*TC*TC CLEAR <index>*

Clears all queued commands for the time code source with index <index>

9.5.2 Prerequisites

The following prerequisites need to be done:

- The system must be equipped with a Plura TC Reader board. This needs to be enabled in the Viz Config File by setting *TCReaderUsage = 1*
- The correct TC source must be set by using *TCReaderSource*

Viz Engine supports LTC, VITC, ATC_LTC, ATC_VITC, HANC_LTC, HANC_VITC.

To specify multiple sources the format would be:

TCReaderSource = LTC | VITC

- Commands need to be sent with a timecode.

For example: *TC*TC_COMMAND SET_TC 1 "12:00:00:00" "-1 RENDERER*MAIN_LAYER SET_OBJECT SCENE*<9968FF26-35B0-4C01-AE5A4F8D11D1543B>*

- Ringbuffer should be turned on

This will make sure that the command to load the given scene will be executed exactly at the given timecode. (12:00:00:00).The fillsize of the ringbuffer will be considered.

.....
To verify this, make sure the final output device (Recorder, Monitor) can display the same timecode as attached to the Viz Engine.
.....

9.5.3 Configuration

To configure a correct field accurate timeout, a few parameters need to be set. Three important values are responsible for a proper playout of Graphics, DVE Live sources and DVE Clips:

Timed Command Bias:

Command: *TC*TC_BIAS SET n* (in fields)

Config Setting: *delayed_command_bias = n*

This presents the overall delay in fields the commands will be sent if the time code hits the timestamp. This affects Graphics and any DVE source. For instance, if your graphics appear 2 frames too late, you need to *use delayed_command_bias = -2*.

.....
The Command *TC*TC_BIAS SET n* will immediately take effect without restarting Viz Engine.
.....

VideoIn[n]DelayDVE:

If you also need to show DVE Live effects in a frame accurate environment, there is also the need to configure the delay of the LiveInput DVE. This is done by setting

Matrox0.VideoIn1.VideoDelayDVE = n

in the config file. This is the number of fields, the DVE signal is delayed until it is shown on the video output. This value can not be negative, the minimum is 1 (0 also represents 1). If your graphics + DVE is still too late, you need to decrease the Timed command bias and adjust the VideoInDelay accordingly.

ClipIn[n]DelayDVE:

Additionally if also clips need to be played exactly at the given timecode and additional parameter comes in play:

ClipIn1.VideoDelayDVE = n

This controls how many fields a clip is being delayed until it shows up on the Video Output.

Note: Clips need always to be cued as they need some time to be read from the hard drive. This is done by sending a

```
SCENE*<uuid> LOAD
```

```
SCENE*<uuid> CUE
```

to the engine a few seconds before the scene is taken to air. Clips must be placed in the stage to be preloaded correctly.

The correct sequence to bring a scene on air exactly at 12:00:00:00 with clips prepared would then be:

```
SCENE*<uuid> LOAD
```

```
SCENE*<uuid> CUE
```

```
TC*TC_COMMAND SET 1 12 00 00 00 "-1 RENDERER*UPDATE SET 0"
```

```
TC*TC_COMMAND SET 1 12 00 00 00 "-1 RENDERER*MAIN_LAYER SET_OBJECT SCENI
```

```
TC*TC_COMMAND SET 1 12 00 00 00 "-1 RENDERER*STAGE START"
```

```
TC*TC_COMMAND SET 1 12 00 00 00 "-1 RENDERER*UPDATE SET 1"
```

Framebuffer Delay

The FramebufferDelay setting is usually used to delay the playout of any graphics. It is used to keep DVE and Graphics in sync when it is set to 0.

However for fine tuning the delays between Graphics, DVE Live and DVE Videos this value needs to be adjusted accordingly.

Matrox0.VideoOut1.FrameBufferDelay = n

9.5.4 Settings for X.mio2 and X.mio2+ boards.

The following settings have been measured for X.mio2 and X.mio2+ boards.

.....
As of the architecture of X.mio3 boards, a frame accurate playout with DVE effects (position and scaling) is currently not possible.

Therefore a X.mio3 board needs to run in X.mio2+ mode (*Matrox.LowLatencyMode = 0*)

.....
 For X.mio2 boards, following settings are needed:

Resolution	TC_BIAS Setting
1080i50	0
720p50	-1
PAL	+8
1080i60M	2
720p60M	0
NTSC	7

For X.mio2+ boards, following settings are needed:

As of the architecture of X.mio2+ boards, more settings need to be done:

Resolution	TC_BIAS Setting	DVE Delay Video	DVE Delay Clips	FramebufferDela
1080i50	0	4	0	4
720p50	6	3	-	4
PAL	0	4	0	4
1080i60M	1	4	0	4
720p60M	6	3	-	4
NTSC	1	4	0	4

.....
Note: Viz Engine 3.9.0 is not able to play Clips, Live and Graphics frame accurately on the X.mio2+ board.

10 Video Wall Configuration

Viz Engine supports output to multiple monitors configured as one large screen, commonly referred to as a video wall. This section details the hardware and software requirements, and how to configure Viz Engine to use a Video Wall.

Viz Engine Video Walls are based on the NVIDIA Mosaic technology for multiple displays, in an array of configurations. This allows for resolutions as high as up to 16k by 16k from one Engine, fully synchronized with the house sync signal, with displays in landscape, portrait or arbitrary rotation layouts at the same time. Although a single Engine solution is recommended, multiple Engines in sync are also supported.

Please take a look at the [Troubleshooting](#) section prior to setting up NVIDIA Mosaic for the first time, as it provides solutions for common issues that may arise during Mosaic setup.

This chapter contains information on the following topics:

- [Hardware Requirements and Recommendations](#)
- [Performance Considerations](#)
- [Video Wall Setup Instructions](#)
- [Troubleshooting](#)

10.1 Hardware Requirements and Recommendations

- [Minimum Hardware Configuration for Video Walls](#)
- [Recommended Configuration for Video Walls](#)
- [Recommended Configuration for Video Walls Using Multiple Graphics Cards](#)

The decision about which hardware to use when setting up a video wall depends a great deal on how the video wall will be used. In the most basic sense, any multi-display setup can be used. However, when in need of a an increased number of displays, clip playback capabilities, live streams, or complex graphics, the demands on the hardware increases significantly. A video board is required for clip playback and input capabilities.

Utilizing the NVIDIA Quadro M6000 graphics cards and the Matrix X.mio3 video board, Viz Engine support video wall configurations with up to 16k by 16k output resolution, and up to eight SDI inputs. Depending on the selected configuration, Viz Engine currently supports the following inputs and outputs for video walls:

- 4-8 SDI inputs, with resolutions ranging from SD to 4K, with a maximum of eight 1080i or one 4K concurrent input.
- 4-16 DisplayPort or DVI outputs, with up to 4K resolution per output.

10.1.1 Minimum Hardware Configuration for Video Walls

- HP Z800-series Desktop Workstation
- NVIDIA Quadro M4000 graphics card

- Matrox X.mio2 video board with optional X.RIO expansion module
- NVIDIA Quadro Sync synchronization card

10.1.2 Recommended Configuration for Video Walls

- HP Z840 Desktop Workstation
- NVIDIA Quadro M6000 graphics card
- Matrox X.mio3 or Matrox DSX LE4 video board
- NVIDIA Quadro Sync synchronization card

10.1.3 Recommended Configuration for Video Walls Using Multiple Graphics Cards

- Supermicro Workstation
- 2-4 NVIDIA Quadro M6000 graphics cards
- Matrox X.mio3 video board
- NVIDIA Quadro Sync synchronization card

10.2 Performance Considerations

For maximum performance, the hardware described in the Recommended Configuration for Video Walls section should be used. In addition, the Engine should be running without GUI. To do this, start Viz Engine with the following command line options:

```
<viz install folder>\viz.exe -n -w
```

10.2.1 Hardware Considerations

As Viz Engine operates in real time, rendering the output field by field, a wide range of factors may influence performance. Each field is rendered within 20 or 16.67 milliseconds, depending on the output format being 50 Hz (PAL) or 59.94 Hz (NTSC), respectively. This means that any requirements added to the render process reduces the time available for rendering the final output. Such requirements can be, but is not limited to:

- Copying between GPUs on a multi-GPU system.
- Copying between CPUs on a multi-CPU system.
- The system bus transfer rate on the system's motherboard.
- The amount of data to be copied and finally rendered.

In other words, adding more GPUs to the system decreases the overall performance, because of the time required for copying information between the GPUs. Therefore, in configurations with multiple graphics cards, the cards should be connected to the same CPU (refer to the motherboard specifications). As a result, single GPU setups are *always* recommended over multi-GPU setups for performance reasons. By adding the [Datapath Fx4](#) display wall controller, a 4K signal can be split into 4 HD signals. This allows to run, for example, a video wall with a total of 16 displays on one M6000 graphics card, with four Datapath Fx4 units.

On a multi-CPU system with two graphics cards, assigning them both to the same CPU can increase performance with as much as 30 percent.

10.2.2 Scene Design Considerations

When designing scenes for a video wall, the design and graphics should be tested on the actual video wall. The scenes can be tested on computer monitors as well, in which case the monitor layout should preferably be as close to that of the video wall the scenes are being designed for, even down to make and model. This is to avoid different configurations, as well as the look and feel of the test configuration.

For the best result, performance tests should always be performed on the actual video wall before taking a new scene on air.

In Viz Artist 3.8.2, the resolution of GFX Channels is by default set to the configured output resolution. To increase performance, limit the GFX channel resolution to the maximum resolution needed, for example 1920 x 1080 for HD resolution. The resolution setting depends on the scenes to be shown and how memory intensive they are.

In multi-GPU configurations, GFX Channels should be added as Texture rather than DVE assets, as the performance improves significantly.

10.3 Video Wall Setup Instructions

This section has information on the following topics:

- [Pre-Requirements for all Setups](#)
- [Configure the NVIDIA driver for Video Wall](#)
- [Order of Steps to Set Up NVIDIA Mosaic](#)
- [NVIDIA Quadro Sync](#)
 - [To Check the Status LEDs of the G-Sync Device](#)

Make sure that the monitor cables are the same for all cards. For example, a video wall configuration with six monitors on two cards, should use three outputs on each card with the same connectors on each card. If required, adapters can be used to connect the displays to the machine.

Make sure the NVIDIA G-SYNC card receives the same reference signal as the video board:

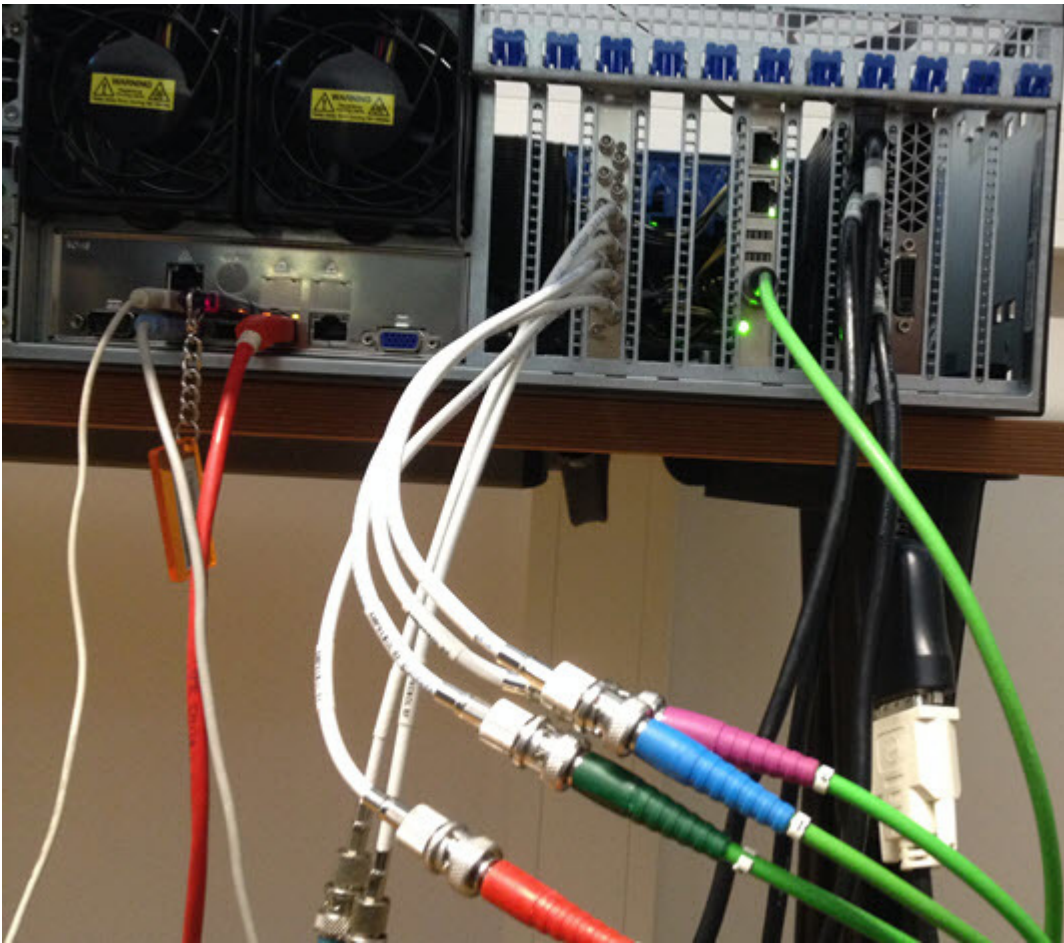

If a Matrox X.mio2 video board is in use, the loop through of the reference signal can be used, as illustrated below:



10.3.1 Pre-Requirements for all Setups

1. Shut down the machine.

2. Install the graphics device, NVIDIA G-Sync board and Matrox X.Mio3. Please refer to the related documentation included with the hardware. For multiple CPU setups with two graphics devices, make sure that both devices are on the same CPU.

.....
IMPORTANT! The NVIDIA M6000 card must be installed using the 8-pin power adapter which is included with the card. Installing the card using a 6-pin power connector will have a negative impact on performance and can lead to unexpected system behavior with reports of a PCI error.

3. Connect the NVIDIA G-Sync and Matrox X.Mio3 to the Genlock source.
 When attaching the connector cables between the graphics card and the G-SYNC card, make sure that the red line on all of the connector cables are facing the card's mounting bracket, towards the back of the case. Failure to do so can result in synchronization issues.
4. Connect the Matrox X.Mio3 video input and output jacks.
5. Connect one monitor only to the graphics card, for the initial setup.
6. Boot the machine.
7. Install NVIDIA drivers and Matrox DSX.Utils. Reboot the machine as required.
8. Shut down the computer and connect all remaining video wall displays to the graphics card. For configurations with more than one graphics card, make sure to use the same outputs on all cards. Boot the machine and proceed with the [Order of Steps to Set Up NVIDIA Mosaic](#).

10.3.2 Configure the NVIDIA driver for Video Wall

1. Using the standard NVIDIA settings for Viz Engine, change the following parameter:
 - **Vertical Sync:**On.
2. Apply the changes, then select 3D App - Video Editing from the profile drop-down menu, and apply changes again:

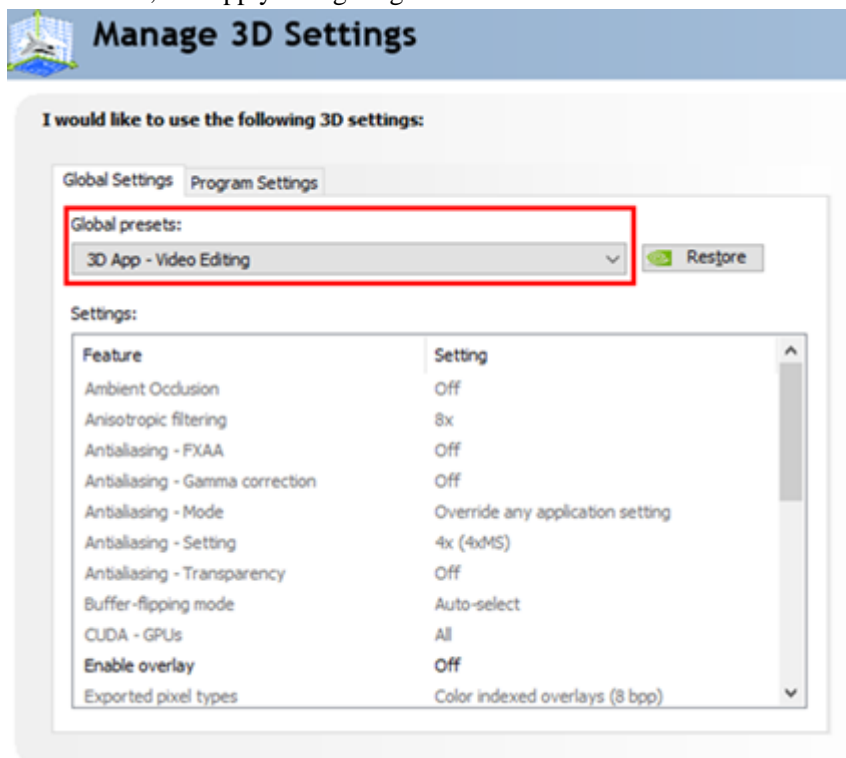

10.3.3 Order of Steps to Set Up NVIDIA Mosaic

Please take a look at the [Troubleshooting](#) section prior to setting up NVIDIA Mosaic for the first time, as it provides solutions for common issues that may arise during Mosaic setup.

.....
IMPORTANT! For 50 Hz setups, make sure that there is no **EDID-file** loaded. Then start the Mosaic configuration, there is no need to perform more steps. For 59.94 Hz, load the EDID-file and make sure it is applied properly by verifying every single monitor in the **View System Topology** panel.
.....

If running with two or more cards, make sure the same outputs are used on each card. For example, if using two DisplayPort outputs and one DVI output on the first card, the same outputs must be used on the second card, etc. Failure to do so may result in Mosaic setup failure, with an error message stating that the configuration is not supported.

1. Enter Mosaic configuration in the NVIDIA control panel and setup Mosaic for the required refresh rate:
 - [NVIDIA Mosaic Configuration for 1080i50](#)
 - [NVIDIA Mosaic Configuration for 1080i60M](#)
2. Synchronize the GPU to the internal house-sync, by configuring the NVIDIA G-Sync device in the **Synchronize displays** panel of the NVIDIA Control Panel:
 - [NVIDIA Quadro Sync](#)
Proceed with adjusting the [Viz Engine Video Wall Configuration Settings](#) to finalize the video wall configuration.

10.3.4 NVIDIA Quadro Sync

The NVIDIA Quadro sync card is used to synchronize the graphics cards with the house clock, and is required for video wall configurations.

V-sync must still be set in the NVIDIA driver to ensure that the OpenGL SwapBuffer operation takes place at the vertical retrace, to avoid tearing between two frames. The Quadro Sync board synchronizes the vertical retrace of all the displays, it does not lock the OpenGL SwapBuffer operation to the vertical retrace.

To Check the Status LEDs of the G-Sync Device

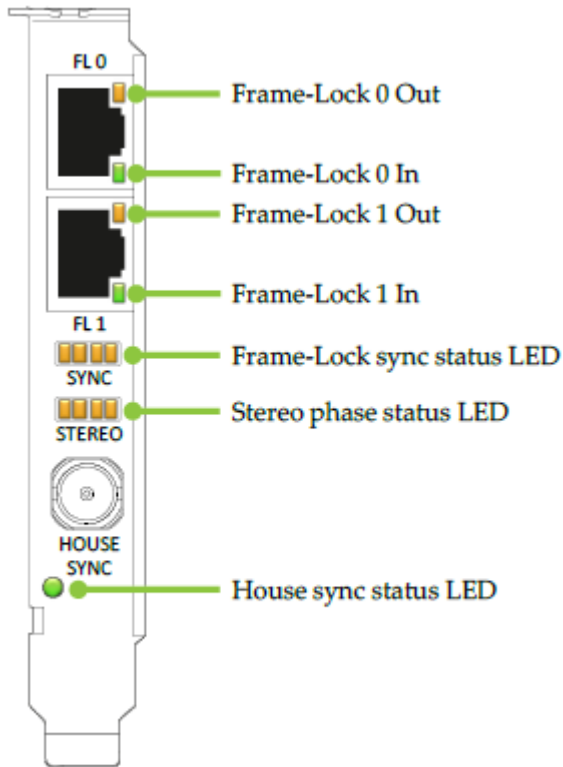

1. Ensure the House sync status LED indicates that a proper sync signal is connected.
2. Ensure that the Frame-Lock sync status LED is shining green. It must not blink or shine orange.
When sync is stable, the Stereo phase status LED should also be lit green.

10.3.5 Custom Resolution for 59.94 Hz Refresh Rate

Video-wall displays may not natively support a refresh rate of 59.94 Hz. Such displays will *always* require an **EDID-file** to be able to run at that frequency. Contact the display hardware vendor to obtain the correct EDID file for the monitors in use. Furthermore, a number of steps must be carried out before initiating the [NVIDIA Mosaic Configuration for 1080i60M](#).

This section contains information on the following topics:

- [To Load an EDID File](#)
- [To Create a Custom 59.94 Hz Resolution](#)
- [To Change from 59.94 Hz to 50 Hz Refresh Rate](#)

.....
Caution: Loading unsupported or corrupted EDID settings for a display may render the source device unable to output any video signal to the display. Please refer to the information supplied by the display hardware vendor for information on the displays capabilities or limitations.
.....

To Load an EDID File

1. In the **NVIDIA Control Panel**, expand the **Workstation** section of the **Select a Task...** menu and click **View system topology**:

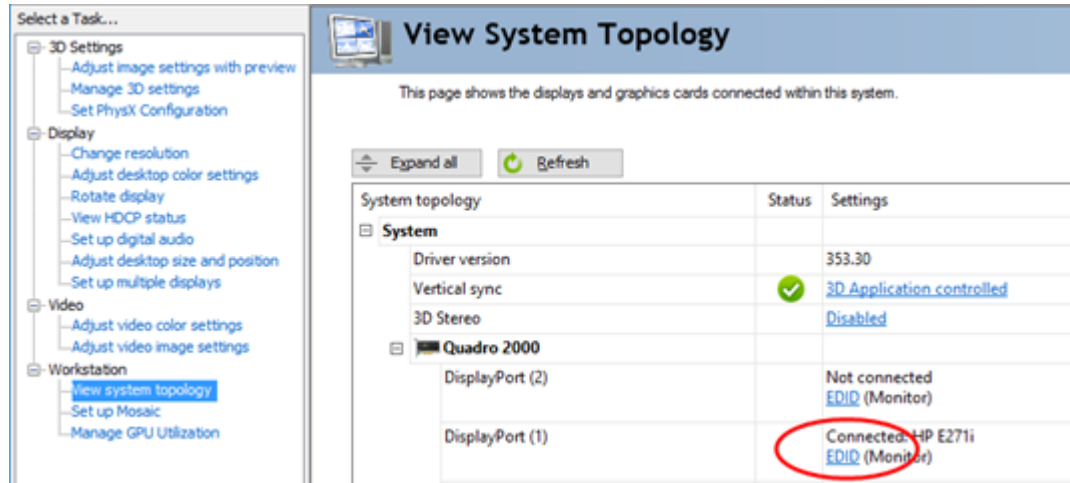

2. Click the **EDID** link on one monitor, and select the **Load** tab.
3. Click the Browse button and select the EDID file to be loaded. This file is usually included on the CD or DVD containing drivers, utilities and documentation for the display. If not, please contact the display manufacturer to obtain the required file.

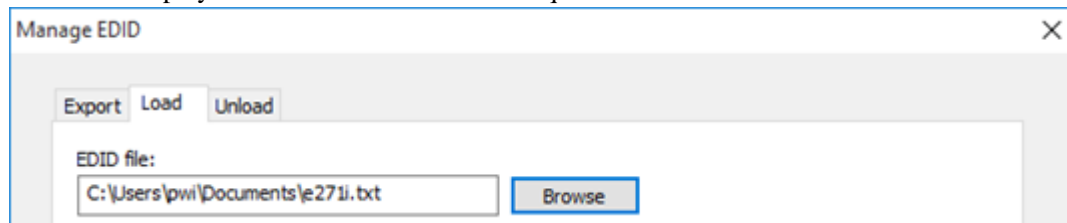

4. In the **Select Connector to force EDID** panel, check all connected displays, then click **Load EDID**.
5. When the EDID file has been applied to all displays, check the properties of every display in the **View System Topology** section. They must all run on 59.94 Hz.
6. Proceed [To Create a Custom 59.94 Hz Resolution](#).

To Create a Custom 59.94 Hz Resolution

1. Enter the **Change resolution** section of the NVIDIA control panel.
2. In the first section, **Select the display you would like to change**, select display number 1 and click the **Customize...** button:

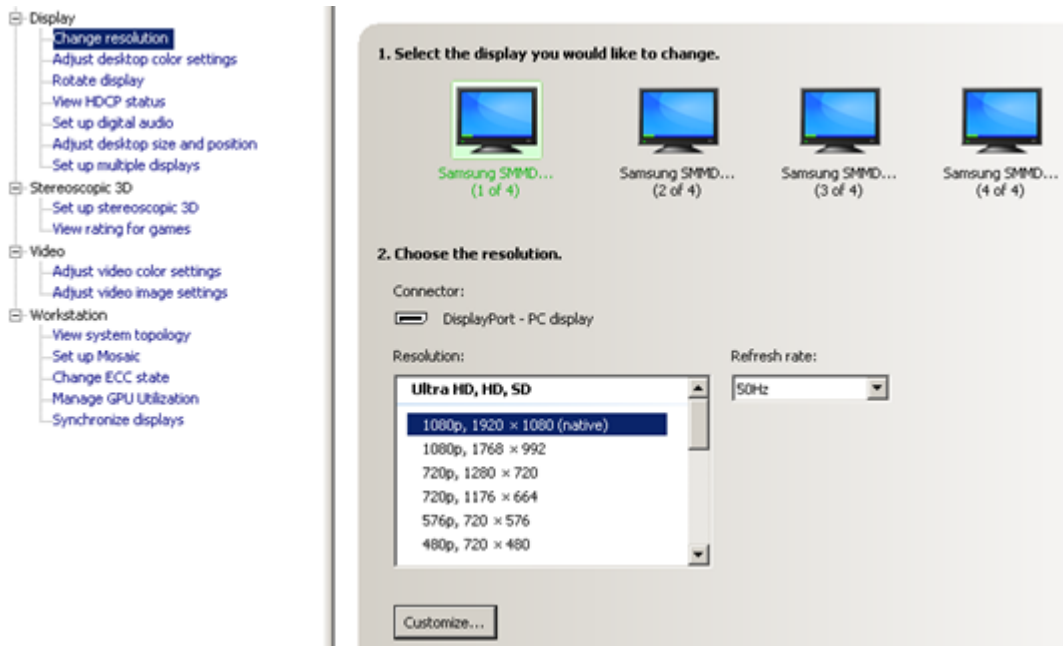

3. In the upcoming dialog, tick the **Enable resolutions not exposed by the display** check box, and click **Create Custom Resolution...**

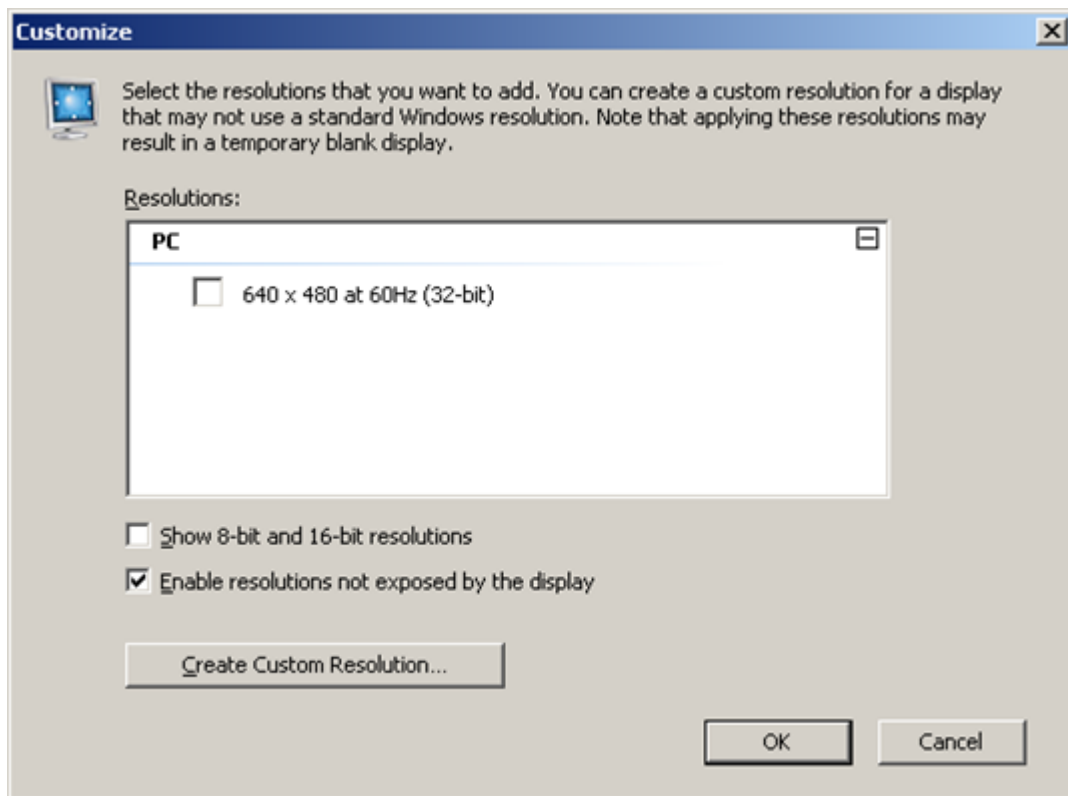

4. Select all displays in the upcoming dialog:

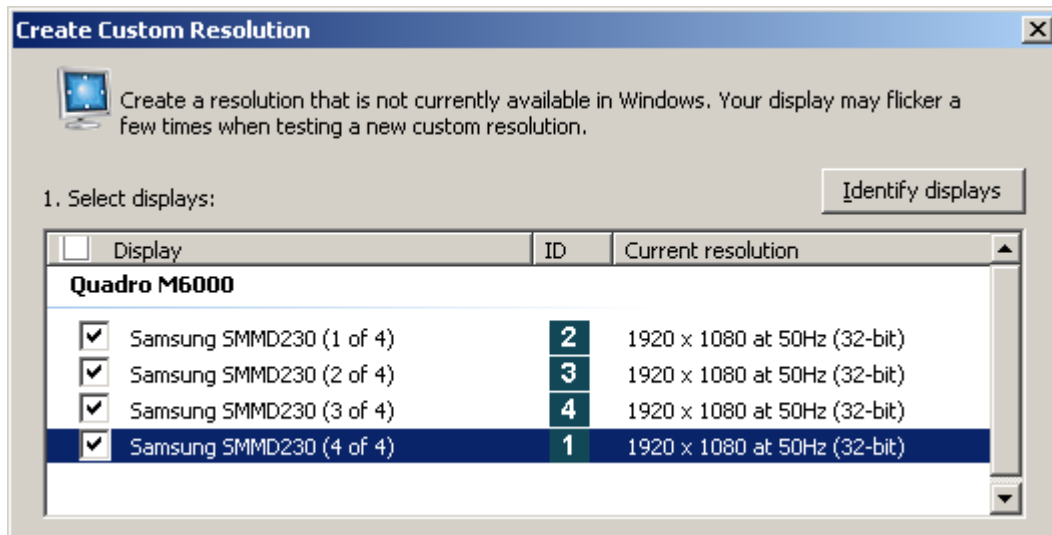

5. Enter a **Refresh rate (Hz)** of 60 Hz and leave all other settings to their default values:

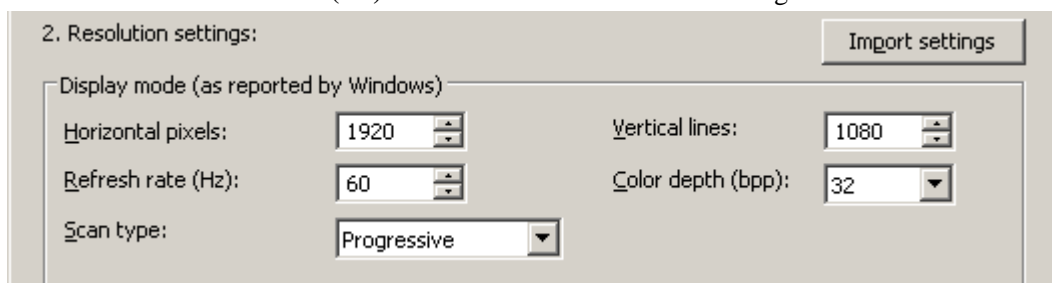

In the Timing panel, select Manual timing adjustment from the **Standard** drop-down list. Set the **Refresh rate** to 59.940 Hz, and leave all other settings to their respective default values:

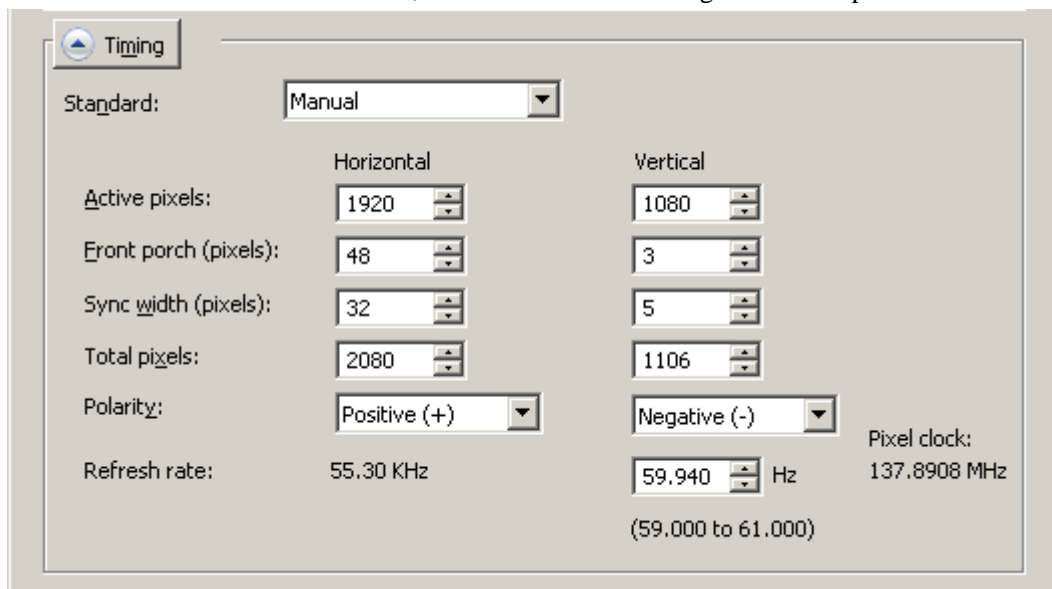

6. Click the **Test** button. The connected monitors might go black for several seconds while adjusting to the new refresh rate. Do not press any key on the keyboard or buttons on the mouse while this goes on. When the screens returns to normal, acknowledge the new settings by pressing **Yes** in the upcoming dialog.

7. The newly created resolution will now show up as illustrated below and will have been applied to all displays.

.....
IMPORTANT! Please note that for 59.94 Hz setups, the server refresh rate might report to be 60 Hz when the external house sync is 59.94 Hz. Even though the custom resolution states to be 60 Hz, the correct value under the hood is 59.94 Hz.
.....

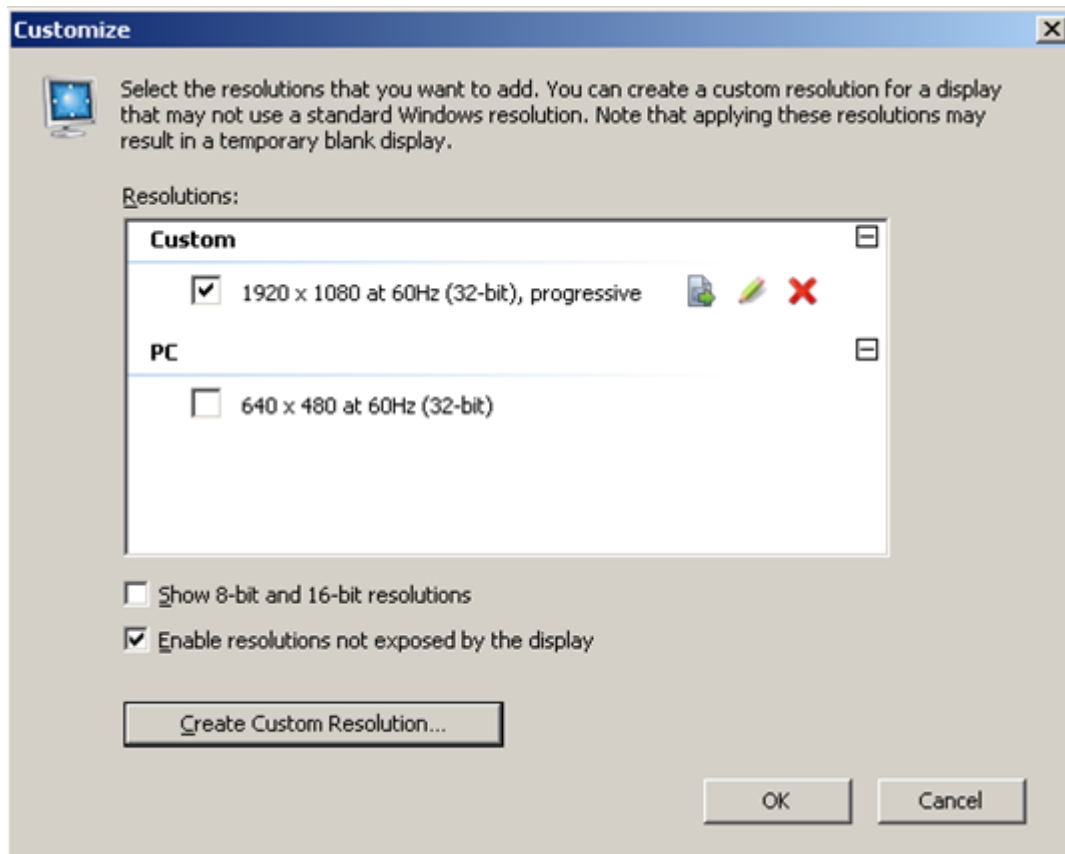

To Change from 59.94 Hz to 50 Hz Refresh Rate

If changing the frequency from 59.94 Hz back to 50 Hz, the EDID file must be unloaded for all connected displays, followed by rebooting the machine. Otherwise, Mosaic can not be applied.

1. In the **NVIDIA Control Panel**, expand the **Workstation** section of the **Select a Task...** menu and click **View system topology**:

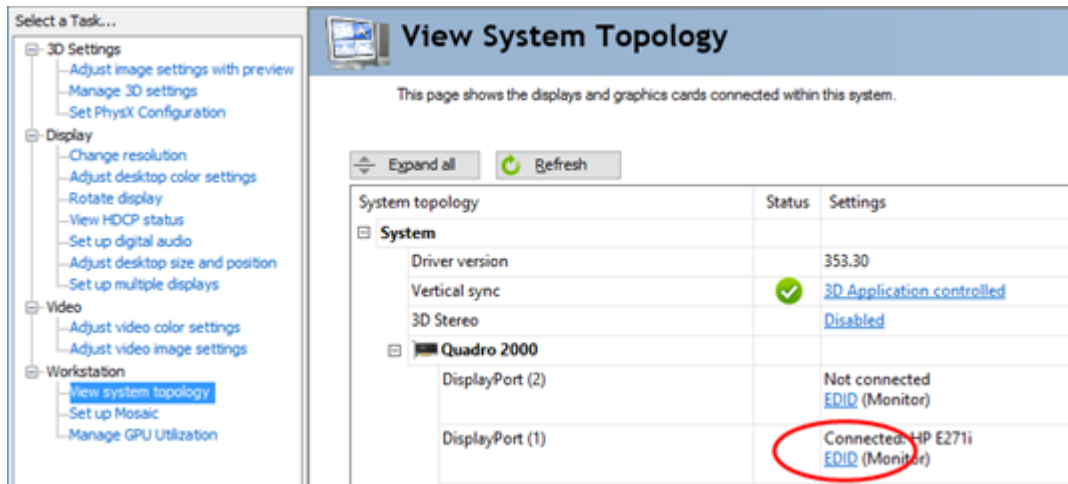

2. Click the **EDID** link on one monitor, and select the **Unload** tab.
3. Select all connected displays and click the **Unload** button.
4. Repeat the step above for all monitors one at a time.
5. Restart the computer and proceed with the [NVIDIA Mosaic Configuration for 1080i50](#).

10.3.6 NVIDIA Mosaic Configuration for 1080i50

The procedure described below assumes that the [NVIDIA Driver Configuration](#) has been completed during initial setup of the computer running Viz Engine. If not, refer to the [NVIDIA Graphics Cards](#) chapter for details on setting up the NVIDIA hardware correctly for use with Viz Engine.

1. Enter NVIDIA Control Panel.
2. Disable synchronization of displays, by selecting **On another system**.

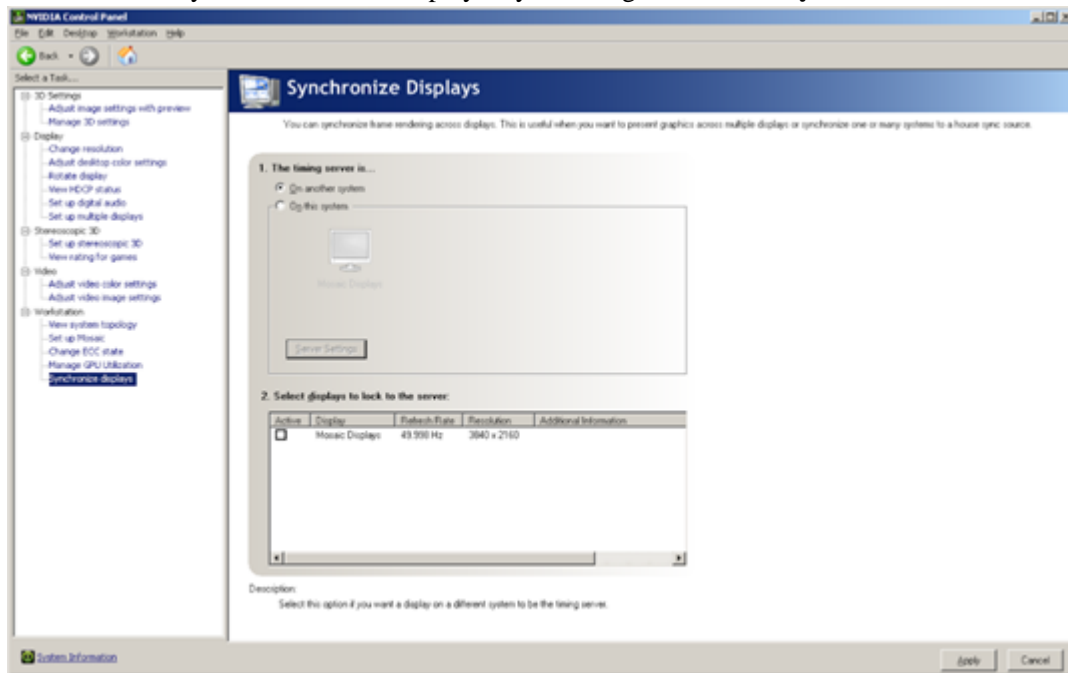

3. Establish a 50Hz Mosaic setup by selecting **Set up Mosaic** from the **Workstation** panel:
 - In step 1. **Select topology**, make sure to leave the **I am using recommended connections for the selected topology** check box unchecked.

- In step **2. Select displays**, select all displays that are to be used for the video wall, for example 1, 2, 3 and 4, and select **50 Hz** as frequency rate.
- In step **3. Arrange displays**, drag and drop the displays according to the physical arrangement, not by the **On Screen Display** numbering. This can result in the monitors being arranged as 1, 4, 3, and 2, ensuring proper layout.

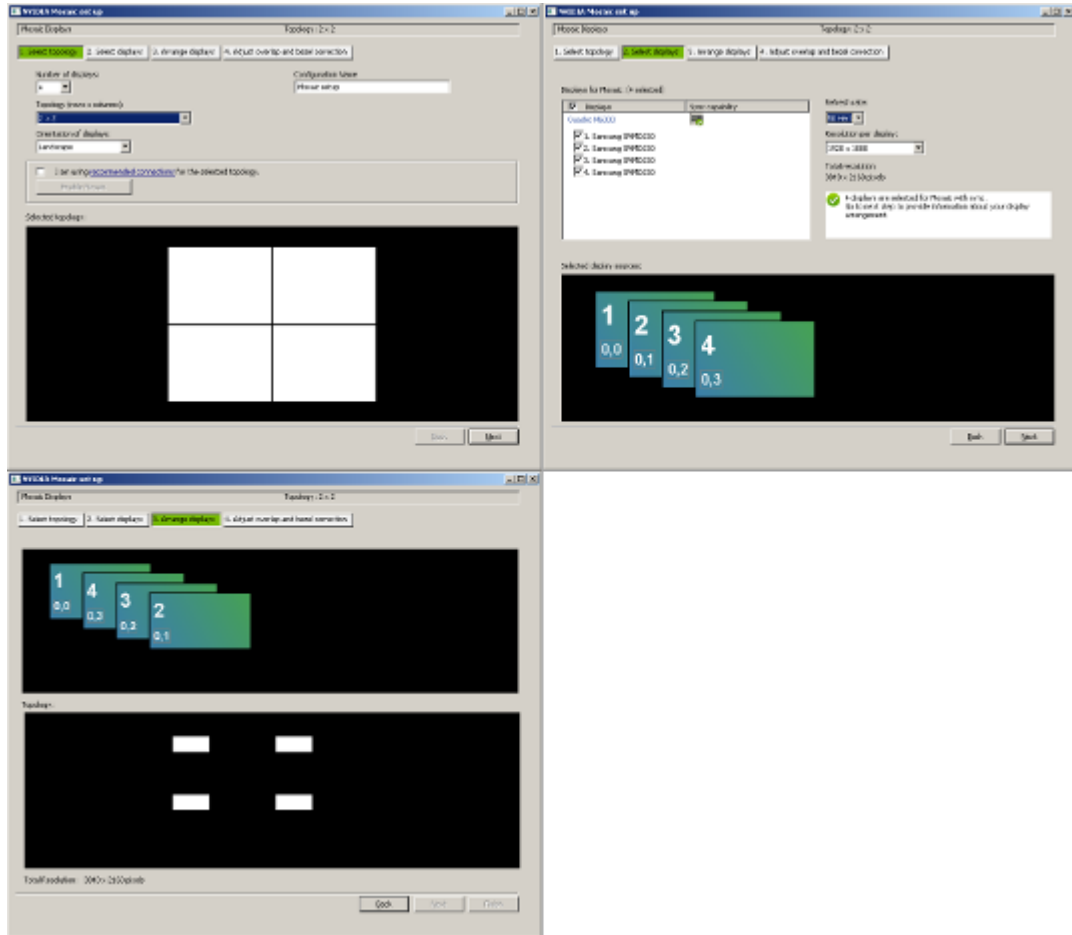

4. Enter section **Synchronize Displays** in the NVIDIA Control Panel and choose **On this system** for the question regarding the timing server, then click the **Server Settings** button.

1. The timing server is...

On another system
 On this system



Mosaic Displays



The timing server is connected to an external house sync source. To change the synchronization properties, click Server Settings.

2. Select displays to lock to the server:

Active	Display	Refresh Rate	Resolution	Additional Information
<div style="border: 1px solid gray; height: 100%; width: 100%;"></div>				

Make sure the presented server refresh rate matches the one of the incoming Genlock signal. Choose **An external house sync signal**. Leave all other settings as they are, and apply the changes.

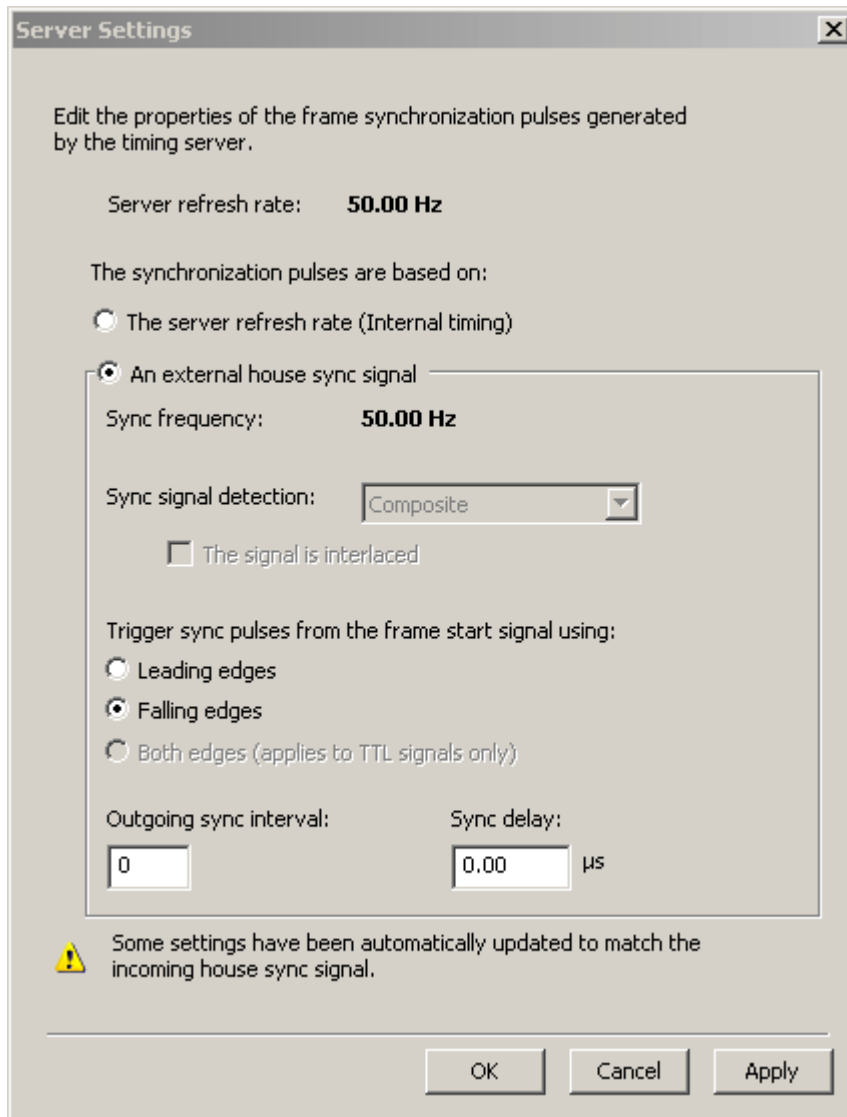

5. Check the **Topology** in the NVIDIA Control Panel:

Mosaic Displays

System topology	Status	Settings
Mosaic Displays		
Configuration		2 x 2 Topology
Resolution, refresh rate		3840 × 2160 pixels, 50.00 Hz
Display Sync State		Quadro Sync Server
Timing		The display is locked to the house sync signal
OS Screen Identifier		2

The **View System Topology** panel will report that **The display is locked to the house sync signal** for one of the connected displays. For the other connected displays, the report will state that **The display is locked to the frame lock sync pulse**.

Displays and Graphics Cards

System topology	Status	Settings
[-] System		
Driver version		353.30
Vertical sync		3D Application controlled
3D Stereo		Disabled
[-] Quadro Sync (server)		
Frame Lock 0		Out
Frame Lock 1		Out
External sync signal		Present (In use)
Frame Lock sync pulse		Present
Sync settings		Synchronize Displays

[-] Samsung SMMD230 (1 of 4)		Mosaic Display (2 x 2 topology)
Display state		Server
[+] Resolution, refresh rate , color depth		3840 × 2160 pixels, 49.998 Hz, 32 bpp
Timing		The display is locked to the house sync signal

[-] Samsung SMMD230 (2 of 4)		Mosaic Display (2 x 2 topology)
Display state		Client
[+] Resolution, refresh rate , color depth		3840 × 2160 pixels, 49.998 Hz, 32 bpp
Timing		The display is locked to the frame lock sync pulse

6. Check the LEDs on the [NVIDIA Quadro Sync](#).
7. Configure Bezel/Overlap for Mosaic in the NVIDIA Control Panel:

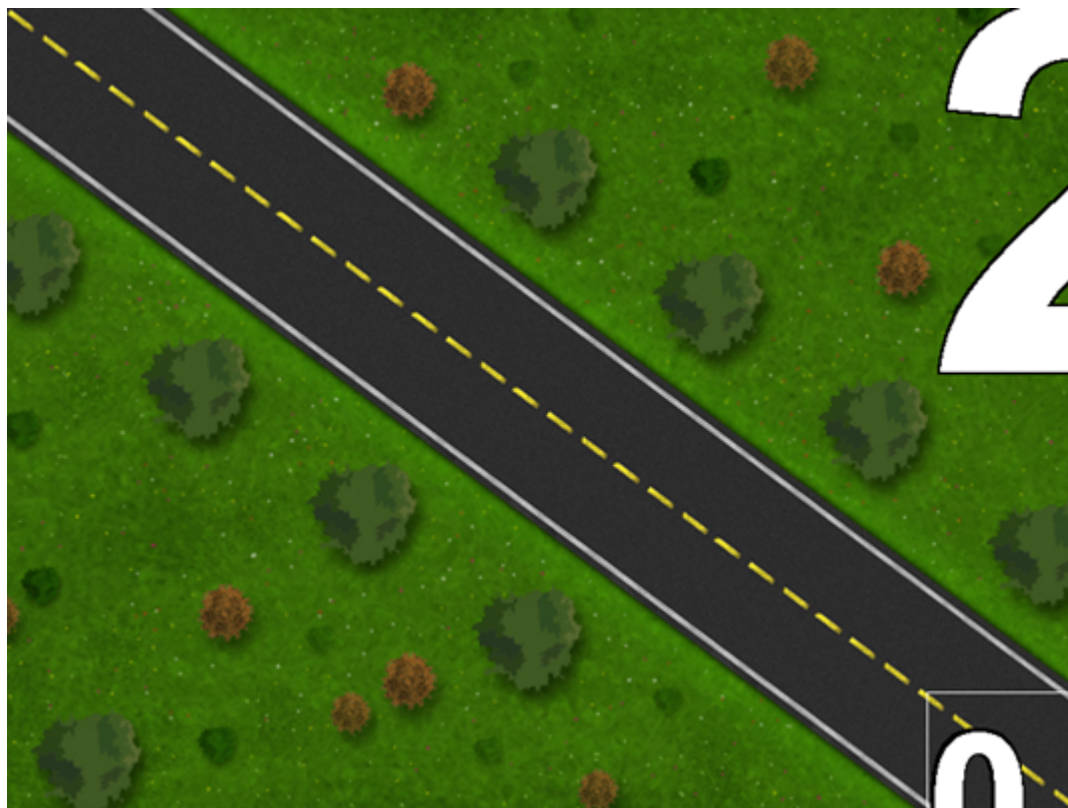
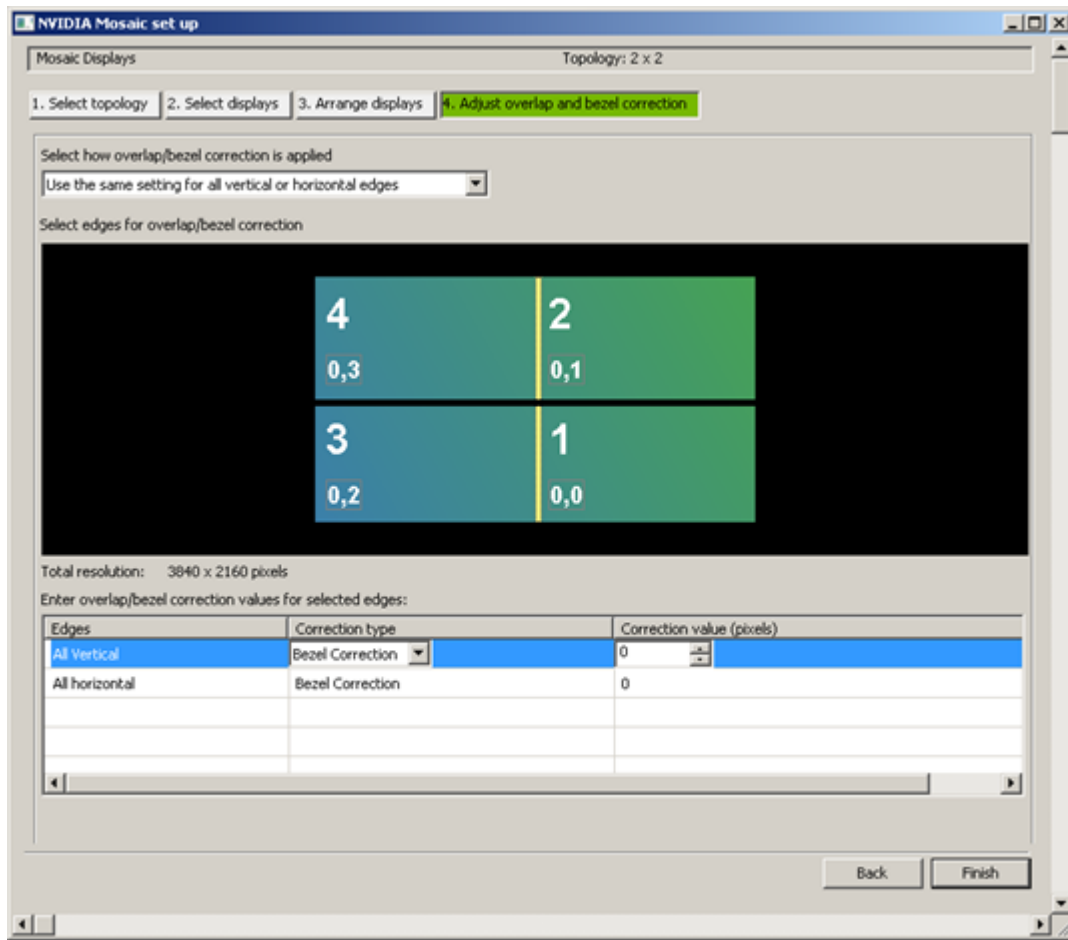

10.3.7 NVIDIA Mosaic Configuration for 1080i60M

In case the video-wall displays in use natively supports a refresh rate of 59.94 Hz, the setup procedure described in [NVIDIA Mosaic Configuration for 1080i50](#) can be followed, only selecting a refresh-rate of 59.94 Hz while creating the Mosaic:

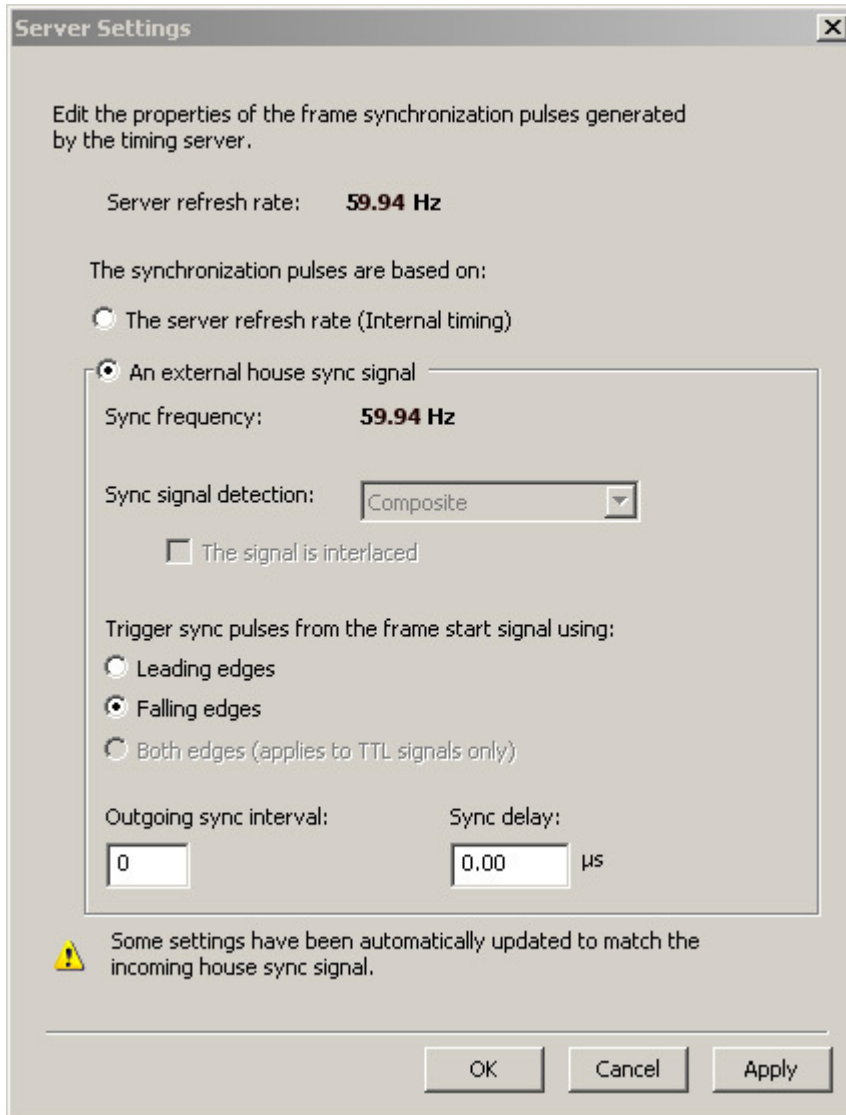

If this is not the case, a number of steps need to be performed in advance, as described in the section [To Create a Custom 59.94 Hz Resolution](#). An **EDID-file** will *always* be required to be able to run monitors that do not natively support 59.94 Hz frequency at that frequency. Contact the display hardware vendor to obtain the correct EDID file for the monitors in use.

1. To configure Mosaic for 1080i60M, follow the steps described in the [NVIDIA Mosaic Configuration for 1080i50](#) section. Make sure to select a refresh-rate of 59.94 Hz during step 2 of the Mosaic creation process. Depending on the NVIDIA driver installer, sometimes 59.94 Hz is not available from the **Refresh rate** drop-down list, even if the loaded EDID-file enables this frequency rate. If this is the case, select 60 Hz:

Refresh rate:
60 Hert: ▾

Resolution per display:
1920 × 1080 ▾

Total resolution:
3840 × 2160 pixels

✓ 4 displays are selected for Mosaic with sync.
Go to next step to provide information about your display arrangement.

- Once Mosaic is configured and the G-Sync device has been locked to the house-sync, the topology in the NVIDIA control panel should look as follows, with the report for one of the connected displays stating **The display is locked to the house sync signal**.

Mosaic Displays

System topology	Status	Settings
<div style="border: 1px solid #ccc; padding: 5px;"> <div style="display: flex; align-items: center;"> <div style="margin-right: 10px;"> Mosaic Displays </div> <div style="flex-grow: 1;"> <ul style="list-style-type: none"> Configuration 2 x 2 Topology Resolution, refresh rate: 3840 × 2160 pixels, 59.94 Hz Display Sync State: Quadro Sync Server Timing: ✓ The display is locked to the house sync signal OS Screen Identifier: 2 </div> </div> </div>		

Displays and Graphics Cards

System topology	Status	Settings
<div style="border: 1px solid #ccc; padding: 5px;"> <div style="display: flex; align-items: center;"> <div style="margin-right: 10px;"> System </div> <div style="flex-grow: 1;"> <ul style="list-style-type: none"> Driver version: 353.30 Vertical sync: ✓ 3D Application controlled 3D Stereo: Disabled </div> </div> </div>		
<div style="border: 1px solid #ccc; padding: 5px;"> <div style="display: flex; align-items: center;"> <div style="margin-right: 10px;"> Quadro Sync (server) </div> <div style="flex-grow: 1;"> <ul style="list-style-type: none"> FrameLock 0: Out FrameLock 1: Out External sync signal: ✓ Present (In use) FrameLock sync pulse: ✓ Present Sync settings: Synchronize Displays </div> </div> </div>		
<div style="border: 1px solid #ccc; padding: 5px;"> <div style="display: flex; align-items: center;"> <div style="margin-right: 10px;"> Samsung SMMD230 (2 of 4) </div> <div style="flex-grow: 1;"> <ul style="list-style-type: none"> Mosaic Display (2 × 2 topology) Display state: Server Resolution, refresh rate , color depth: 3840 × 2160 pixels, 59.939 Hz, 32 bpp Timing: ✓ The display is locked to the house sync signal </div> </div> </div>		

The report for all other displays should be that **The display is locked to the frame lock sync pulse**.

[-] M Samsung SMMD230 (3 of 4)	Mosaic Display (2 x 2 topology)
Display state	Client
+ Resolution, refresh rate , color depth	3840 x 2160 pixels, 59.939 Hz, 32 bpp
Timing	 The display is locked to the frame lock sync pulse

3. Check the LEDs of the [NVIDIA Quadro Sync](#).
4. Configure Bezel/Overlap for Mosaic in NVIDIA control panel:

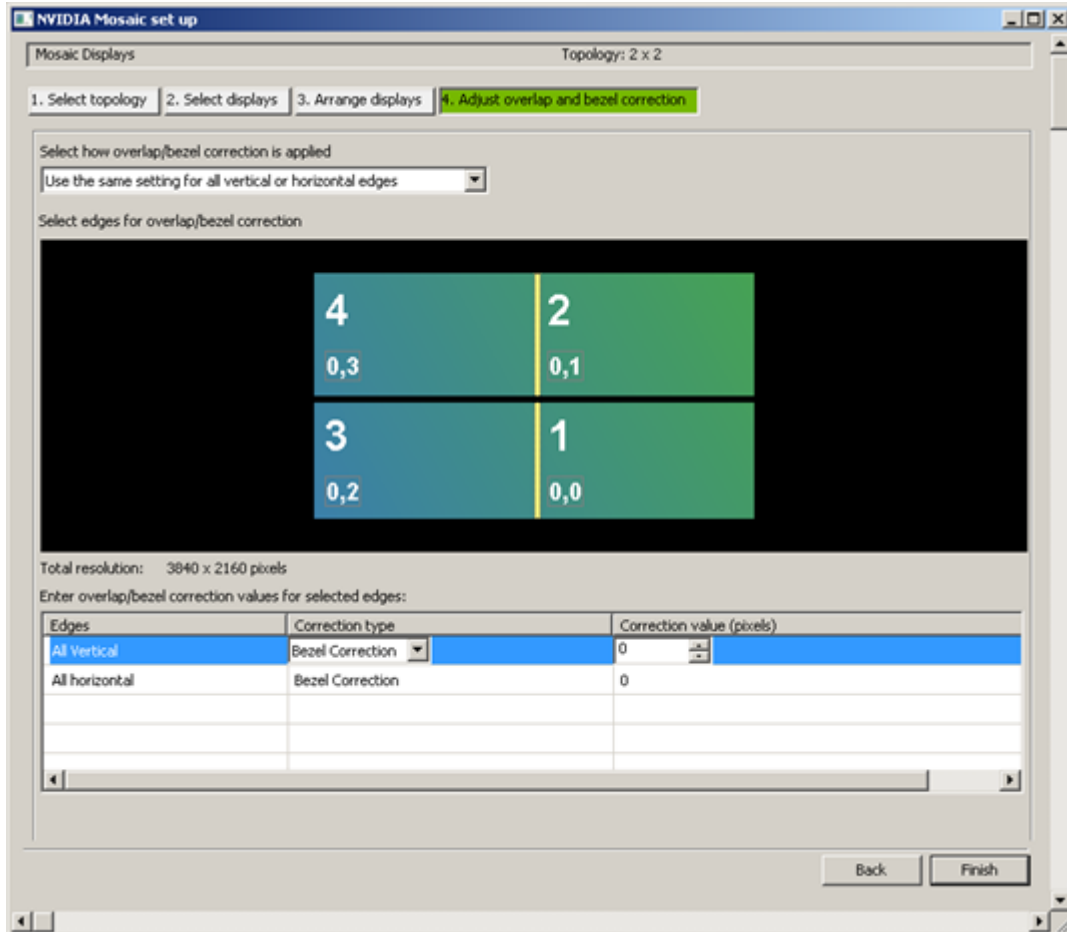

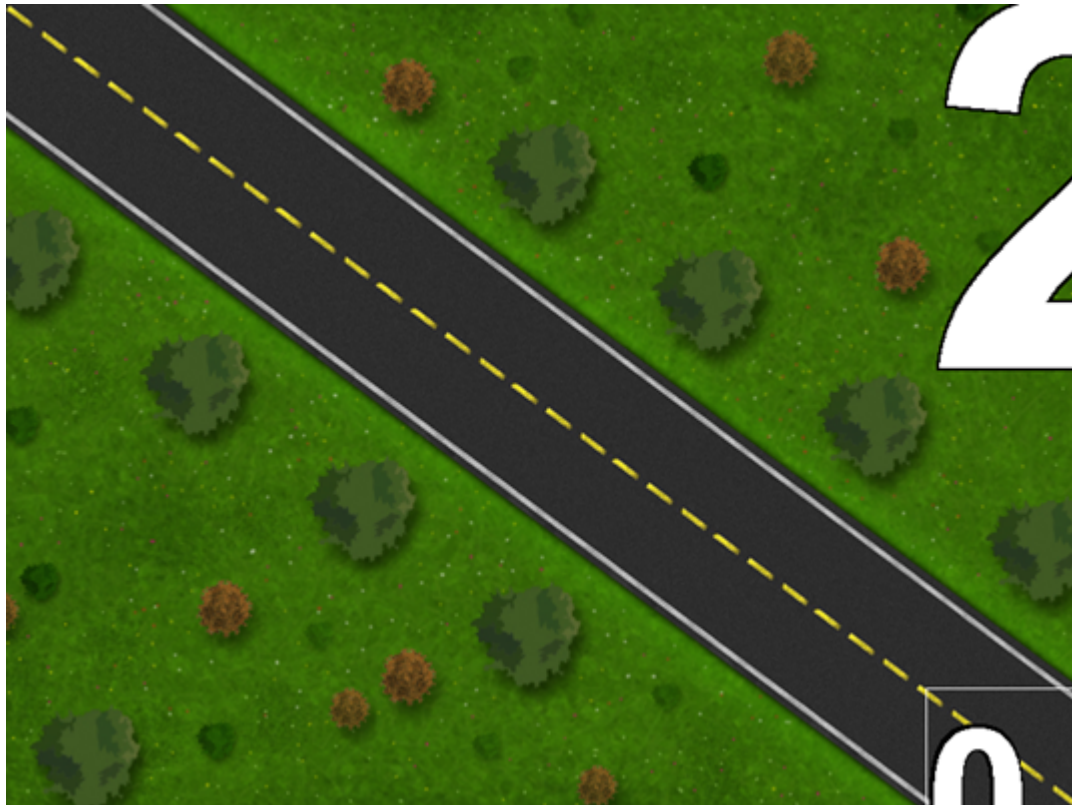

5. Proceed with configuring the required [Viz Engine Video Wall Configuration Settings](#).

10.3.8 Viz Engine Video Wall Configuration Settings

To configure Viz Engine for Video Wall

1. Open Viz Configuration, and create a backup of the existing configuration settings by saving them to a new file.
2. Import a configuration profile for the desired input format from the selection of [Installed Configuration Profiles](#). These ship with the Engine installation, and are located in the <viz install folder>\Configuration Profiles folder. The input format files are named video-resolution-*.cfg, where the asterisk represents the frame rate the configuration is suitable for, if it includes audio settings, and which video hardware it is designed for. For example, the audio enabled configuration file for the Matrox X.mio3 video board running in 1080i50 resolution, is called video-resolution-1080i50-audio-xmio3.cfg.
3. Next, import a Video wall configuration profile, where the frame rate matches the one loaded for the video hardware in the previous step. As with the input format profiles, these are located in the <viz install folder>\Configuration Profiles folder. These configuration files are named videowall-*.cfg, where the asterisk represent the frame rate the selected configuration file is suitable for:

```

C:\Windows\system32\cmd.exe

Directory of C:\Program Files\vizrt\Viz3\Configuration Profiles

02-Mar-16 12:06 AM          1,706 videowall-1080i25-audio.cfg
02-Mar-16 12:06 AM          1,693 videowall-1080i25-video-audio.cfg
02-Mar-16 12:06 AM          1,789 videowall-1080i25.cfg
02-Mar-16 12:06 AM          1,707 videowall-1080i30M-audio.cfg
02-Mar-16 12:06 AM          1,693 videowall-1080i30M-video-audio.cfg
02-Mar-16 12:06 AM          1,790 videowall-1080i30M.cfg
                6 File(s)          10,378 bytes
                0 Dir(s)  84,284,010,496 bytes free

C:\Program Files\vizrt\Viz3\Configuration Profiles>_

```

4. Adjust the **Output Format** in Viz Config:

- Verify that **Fullscreen** is the selected format in the output format specification list.
- The frame rate should have been set when loading the `videowall-* .cfg` configuration profile in step two. Ensure that the correct values are set for the required output. For PAL systems, set the **Frame** value to 50. For NTSC systems, set the **Frame** value to 59.94.
- Set the **Aspect** value to the aspect ratio of the video wall. The aspect ratio decimal value is found by dividing the number of pixels, width by height. This value depends on the actual video wall display layout and needs to be adjusted if changes to the display layout are made.

Name	Specification	Dimension	Frequency	Aspect
NTSC	480I_5994_SMPT259_NTSC	720 x 486	59.94 Hz	16:9
PAL	576I_5000_SMPT259_PAL	720 x 576	50.00 Hz	4:3
PAL	576I_5000_SMPT259_PAL	720 x 576	50.00 Hz	16:9
720p HD Progressive	720P_5000_SMPT296	1280 x 720	50.00 Hz	16:9
720p HD Progressive	720P_5994_SMPT296	1280 x 720	59.94 Hz	16:9
720p HD Progressive	720P_6000_SMPT296	1280 x 720	60.00 Hz	16:9
1080i HD Interlaced	1080I_5000_SMPT274	1920 x 1080	50.00 Hz	16:9
1080i HD Interlaced	1080I_5994_SMPT274	1920 x 1080	59.94 Hz	16:9
1080i HD Interlaced	1080I_6000_SMPT274	1920 x 1080	60.00 Hz	16:9
1080p HD	1080P_5000_SMPT424M	1920 x 1080	50.00 Hz	16:9
1080p HD	1080P_5994_SMPT424M	1920 x 1080	59.94 Hz	16:9
1080p HD	1080P_6000_SMPT424M	1920 x 1080	60.00 Hz	16:9
2160p UHD TV1	2160P_5000_SMPT2036_UHDTV1	3840 x 2160	50.00 Hz	16:9
2160p UHD TV1	2160P_5994_SMPT2036_UHDTV1	3840 x 2160	59.94 Hz	16:9
2160p UHD TV1	2160P_6000_SMPT2036_UHDTV1	3840 x 2160	60.00 Hz	16:9
2160p 2SI UHDTV1	2160P_5000_SMPT425_S_UHDTV1	3840 x 2160	50.00 Hz	16:9
2160p 2SI UHDTV1	2160P_5994_SMPT425_S_UHDTV1	3840 x 2160	59.94 Hz	16:9
2160p 4K	2160P_5000_SMPT2036_4K	4096 x 2160	50.00 Hz	256:135
2160p 4K	2160P_5994_SMPT2036_4K	4096 x 2160	59.94 Hz	256:135
2160p 4K	2160P_6000_SMPT2036_4K	4096 x 2160	60.00 Hz	256:135
Fullscreen	FULLSCREEN	1920 x 1080	59.94 Hz	
User Defined	USER_DEFINED	1920 x 1080	59.94 Hz	

User Defined	
X	0
Y	0
Width	1920
Height	1080
Frame	59.94
Aspect	1.33

5. Verify the following **Video Output** settings:

- **Video wall/Multi-display** should be set to Active.
- Click the **Show Video Output Config. Editor** button and verify that the required Genlock is set. For configurations with the Matrox X.Mio3 video board, Genlock must be set to **Auto**. Other configurations can be set to **Auto**, **Blackburst** or **Tri-Level**, as required:

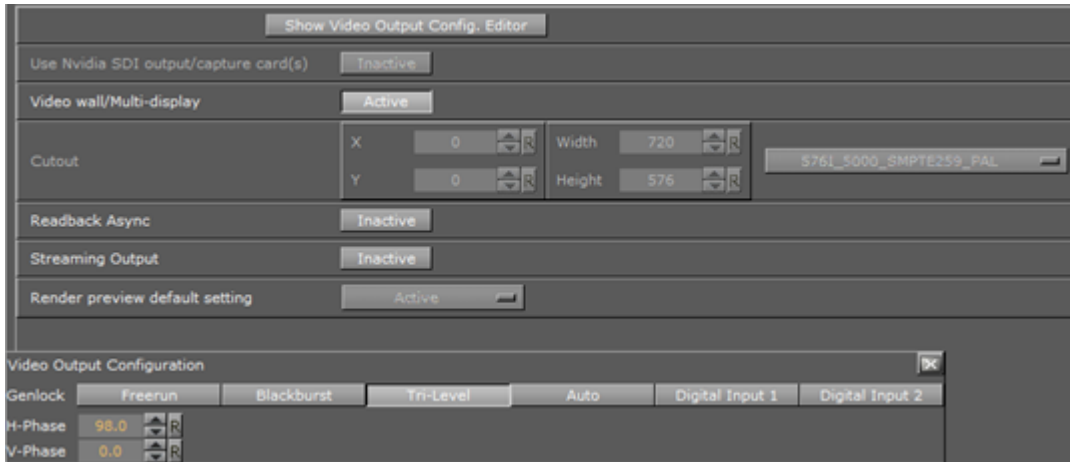

6. Under [Render Options](#), disable **On Air Mouse Cursor**.
7. In the [Video Input](#) section, enable the required number of **Live** and **Clip Channel** sources. Unused live inputs should be deactivated, as activating them could have an impact on performance.

Live 1		Live 2		Live 3		Live 4	
SD i	SD i	SD i	SD i	SD i	SD i	SD i	SD i
HD 720p	HD 720p	HD 720p	HD 720p	HD 720p	HD 720p	HD 720p	HD 720p
HD 1080i	HD 1080i	HD 1080i	HD 1080i	HD 1080i	HD 1080i	HD 1080i	HD 1080i
HD 1080p	HD 1080p	HD 1080p	HD 1080p	HD 1080p	HD 1080p	HD 1080p	HD 1080p
inactive	inactive	inactive	inactive	inactive	inactive	inactive	inactive
Clip Channel 1		Clip Channel 2		Clip Channel 3		Clip Channel 4	
SD i	SD i	SD i	SD i	SD i	SD i	SD i	SD i
HD 720p	HD 720p	HD 720p	HD 720p	HD 720p	HD 720p	HD 720p	HD 720p
HD 1080i	HD 1080i	HD 1080i	HD 1080i	HD 1080i	HD 1080i	HD 1080i	HD 1080i
HD 1080p	HD 1080p	HD 1080p	HD 1080p	HD 1080p	HD 1080p	HD 1080p	HD 1080p
UHD 2160p	UHD 2160p	UHD 2160p	UHD 2160p	UHD 2160p	UHD 2160p	UHD 2160p	UHD 2160p
UHD 2160p 2si	UHD 2160p 2si	UHD 2160p 2si	UHD 2160p 2si	UHD 2160p 2si	UHD 2160p 2si	UHD 2160p 2si	UHD 2160p 2si
4K 2160p	4K 2160p	4K 2160p	4K 2160p	4K 2160p	4K 2160p	4K 2160p	4K 2160p
inactive	inactive	inactive	inactive	inactive	inactive	inactive	inactive
Stream 1		Stream 2		Stream 3		Stream 4	
SD i	SD i	SD i	SD i	SD i	SD i	SD i	SD i
HD 720p	HD 720p	HD 720p	HD 720p	HD 720p	HD 720p	HD 720p	HD 720p
HD 1080i	HD 1080i	HD 1080i	HD 1080i	HD 1080i	HD 1080i	HD 1080i	HD 1080i
HD 1080p	HD 1080p	HD 1080p	HD 1080p	HD 1080p	HD 1080p	HD 1080p	HD 1080p
inactive	inactive	inactive	inactive	inactive	inactive	inactive	inactive

8. Disable GPU-Direct in the [Video Board](#) section of Viz Configuration.
9. Manually edit the configuration file, and set the flag `use_threaded_io` to 1.
10. In the [Database](#) section, specify which Viz Graphic Hub to use and provide the login credentials.
11. Start Viz Engine without a User Interface, by executing the following from the command line:

```
<viz install folder>\viz.exe -n -w
```

12. Load a scene containing a single live-video or clip source as a texture and scale it up to full screen. If running Viz Artist, switch to [On Air Mode](#). Watch for drops in the video wall output within the first 60 seconds.
13. Verify the configuration of the NVIDIA driver by checking the Topology Inspector, and check the Viz Engine configuration. This is especially important when setting up a 59.94 Hz video-wall, as a wrong refresh-rate of 60 Hz could get applied to the displays by mistake.
14. In general, a proper Mosaic setup is automatically synchronized with Viz Engine. However, it can be necessary to force Viz Engine to synchronize. This is necessary for all setups with multiple graphics cards.

To force synchronization, issue the following command in the Engine Console:

.....
IMPORTANT! Do not execute this command unless needed, as this may have an impact on performance.

```
send RENDERER JOIN_SWAPGROUP 1
```

If the computer is rebooted or Viz Engine restarted, the command needs to be sent again. To avoid doing this manually every time the Engine starts, set the `swapgroup` value in the **RENDER_OPTIONS** section of the configuration file to 1. The default value is 0.

.....
 This synchronization can also remedy certain tearing effects. Create a simple scene with a bar running left to right. If any of the connected monitors display tearing effects, try sending the above command.

Audio Output

For performance reasons, in a Video Wall setup the video out channels will usually be set to **Unused**. To configure a Video Wall with embedded or AES audio output, the video out channel must be mapped to the selected Matrox channel. Set **Map to Viz Channel** in the [Matrox VideoOut Properties](#) in Viz Configuration.

.....
Note: When running a Video Wall with audio out, even though the video out channel is mapped, the SDI output will be black.

10.4 Troubleshooting Video Wall Configurations

Please take a look at this section prior to configuring a Video Wall for the first time. It provides solutions for common issues which may arise during setup, and covers the following topics:

- [Performance issues](#)
- [Steps to recover from severe NVIDIA Mosaic driver related issues](#)
- [Experiencing BSOD or system freeze while setting up Mosaic](#)
- [Only some displays of the Video Wall display an image](#)
- [Missing NVIDIA Control Panel settings](#)
- [NVIDIA Control Panel crashes](#)
- [Mosaic configuration not supported error](#)
- [G-Sync status LEDs or Topology reports indicate a synchronization issue](#)
- [Poor performance when using GFX channels as DVE](#)

- [Jittering on HP Z840](#)
- [Other synchronization issues](#)

10.4.1 Performance issues

Create a simple scene with a bar moving from left to right and back in an endless loop, and run this scene on the newly configured Video Wall to spot issues such as jittering, tearing effects, etc. When troubleshooting performance issues, always make sure to check the following before investigating further:

- Make sure that the system meets the [Minimum Hardware Configuration for Video Walls](#).
- Make sure that the [Pre-Requirements for all Setups](#) are met.
- Check that graphics and video devices are on the same CPU bus. The GPUs should always have priority. Refer to the slot layout tables for the [Supermicro SuperServer 7048 GR-TR](#) or [HP Z840](#), respectively, for details.
- Make sure that the power connector to the graphics device is connected properly. The power connector must be 8-pin or use the 6-to-8-pin adapter included with the graphics device.
- Check that the [HP Z840](#) or [Supermicro BIOS Settings](#) are correctly configured.
- Check the [Viz Engine Video Wall Configuration Settings](#).
- [Configure the NVIDIA driver for Video Wall](#).

If performance problems persist, a possible solution may be to increase the **Reactivation Delay** value in Viz Configuration. Please refer to the setting [Video Input: Clip Input](#).

10.4.2 Steps to recover from severe NVIDIA Mosaic driver related issues

1. Remove the NVIDIA drivers.
2. Shutdown the system.
3. Ensure that all monitor cables are connected properly to the graphics card.
4. Boot the system.
5. Reinstall the NVIDIA drivers.

10.4.3 Experiencing BSOD or system freeze while setting up Mosaic

While operating in Mosaic mode, any changes to the physical setup, such as adding or removing monitors, can cause a system crash resulting in a Blue Screen of Death or complete system freeze. There is a chance to run into follow-up issues (mentioned in this chapter) after the system has rebooted.

10.4.4 Only some displays of the Video Wall display an image

The reasons for this can be many-fold. Please ensure that:

- All monitors are connected properly to the graphics device and that they are active.
- Delete and re-create your Mosaic setup in the NVIDIA Control Panel.
- Please refer to section [Steps to recover from severe NVIDIA Mosaic driver related issues](#) in case the issue persists.

10.4.5 Missing NVIDIA Control Panel settings

Please perform a re-installation of the NVIDIA driver as mentioned in section [Steps to recover from severe NVIDIA Mosaic driver related issues](#). A known cause for this behavior are physical changes to an existing video-wall setup, for instance adding or removing monitors, while operating in Mosaic mode.

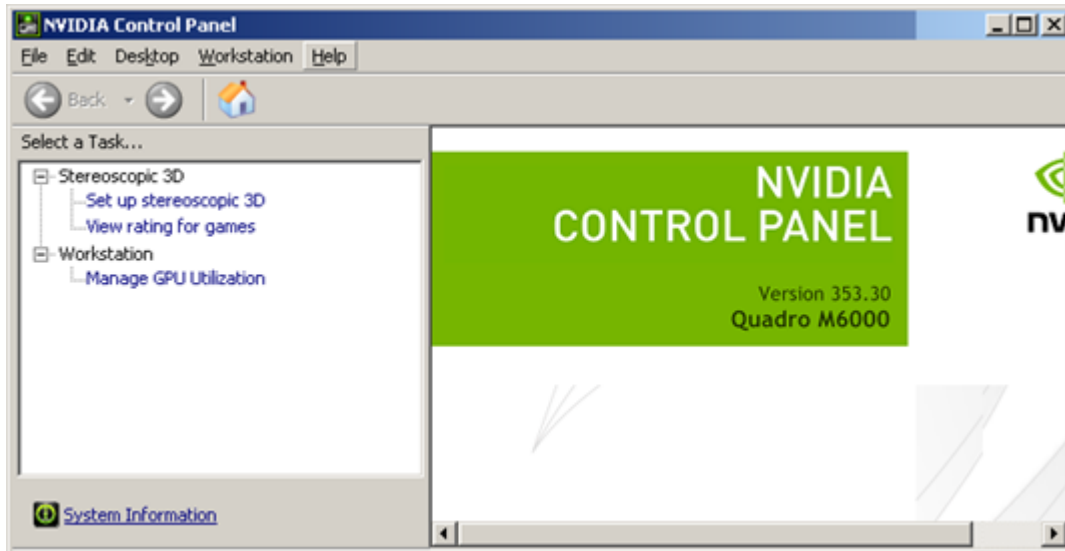

10.4.6 NVIDIA Control Panel crashes

There is a possibility that the NVIDIA Control Panel crashes during Mosaic configuration, although this is not considered a reliable indicator on whether a driver re-installation is required or not. Sometimes the NVIDIA Control Panel can be restarted manually, and usually rebooting the machine should suffice.



Please refer to section [Steps to recover from severe NVIDIA Mosaic driver related issues](#) if the issue persists.

10.4.7 Mosaic configuration not supported error

If running with two or more cards, make sure the same outputs are used on each card. For example, if using two DisplayPort outputs and one DVI output on the first card, the same outputs must be used on the second card, etc. Failure to do so may result in Mosaic setup failure, with an error message stating that the configuration is not supported.

10.4.8 G-Sync status LEDs or Topology reports indicate a synchronization issue

If the status LEDs on the NVIDIA G-Sync status LEDs indicate an issue, or the topology reports "The display is locked to the house sync signal" for all displays, the topology view may indicate that everything is fine at first sight. However, when taking a closer look at the topology, it reveals that all monitors seem to sync to the **house sync signal** instead of reporting that the display is locked to the **frame lock sync** pulse:

☐	 Samsung SMMD230 (1 of 4)		Mosaic Display (2 x 2 topology)
	Display state		Server
☑	Resolution, refresh rate , color depth		3840 x 2160 pixels, 49.998 Hz, 32 bpp
	Timing		The display is locked to the house sync signal

This indicates that there exists an synchronization issue which needs to be fixed. Solving this may require going through one or several of the following steps:

1. Re-establish synchronization

- a. Disable display synchronization in section **Synchronize Displays**.
- b. Re-establish synchronization.
See the [NVIDIA Mosaic Configuration for 1080i50](#) or [NVIDIA Mosaic Configuration for 1080i60M](#) sections for more detailed instructions.

2. Reconnect G-SYNC signal cables

- a. Physically disconnect the sync cable from the G-SYNC card.
- b. Reconnect the sync cable.
- c. Switch synchronization back on in the NVIDIA Control Panel. Go to **Synchronize Displays** and set the radio button to **An external house sync signal**. See the [NVIDIA Mosaic Configuration for 1080i50](#) or [NVIDIA Mosaic Configuration for 1080i60M](#) sections for more detailed instructions.
- d. Verify the LEDs on the [NVIDIA Quadro Sync](#), or in the Topology Inspector of the NVIDIA Control Panel.
- e. If this does not help, try to reboot the machine.
In case this does not fix the issue, please:

- 1. Disable display synchronization in section Synchronize Displays.
- 2. Shutdown the machine.
- 3. Check cabling and signal sources.
- 4. Reboot the machine.
- 5. Re-establish synchronization as mentioned in section Synchronize Displays.

10.4.9 Poor performance when using GFX channels as DVE

On high resolution Video Walls in particular, poor performance may be experienced when using GFX channels as DVEs. This is caused by anti-aliased "blitting". To disable anti-aliasing on GFX channels, open the Viz configuration file, locate the `gfx_channels_antialiased` string, and set the value to 0. The default value is 1.

```
.....
Example: gfx_channels_antialiased = 1
.....
```

Note

Turning on **GPUDirect** can result in less performance than running without it. There is a workaround for this problem and we recommend to use this setting in video wall setups. Enable the flag **use_threaded_IO** in the configuration file.

Setting: `use_threaded_IO = 1`

10.4.10 Jittering on HP Z840

Jittering on the HP Z840 is most commonly caused by a missing swapgroup. Make sure to run the `RENDERER_JOIN_SWAPGROUP 1` command to the Engine.

10.4.11 Other synchronization issues

When attaching the connector cables between the graphics card and the G-SYNC card, make sure that the red line on all of the connector cables are facing the card's mounting bracket, towards the back of the case. Failure to do so can result in synchronization issues.

In rare cases, syncing with only the NVIDIA G-SYNC can result in more stable synchronization. If all else fails, try disconnecting the reference signal from the Matrox board.

11 NVIDIA Graphics Cards

This section describes the NVIDIA graphics cards, their configuration and drivers supported by Viz Engine.

.....
IMPORTANT! Any other setup than those described is not guaranteed to be supported by Viz and may cause problems during operation.
.....

.....
Note: Vizrt may make changes to specifications and product descriptions at any time, without notice.
.....

This section contains information on the following topics:

- [Working with Two Graphics Cards](#)
- [Working with Synchronous Output](#)
- [NVIDIA Driver Configuration](#)
- [NVIDIA Driver History](#)

See Also

- [Video, Audio, Server and Graphics Card Installation](#)

11.1 Working with Two Graphics Cards

A machine with two graphics cards can run two instances of Viz Engine simultaneously.

Currently there are three options;

- **Two Program Outputs:** Use two instances that can run two program channels, e.g. one for SD and one for HD output.
- **One Program Output and One Preview Output:** Run a control application with one instance for preview and one instance for program output with video. Ideal for Outside Broadcast environments.
- **One Program Output for Stereoscopic:** Produce graphics composited for stereoscopic use. In addition this will also save rack unit space as all hardware is installed into one machine.

.....
Note: The limitations to such systems, in general and not limited to Vizrt alone, is memory usage and access, and also lack of power redundancy.
.....

See Also

- [Working with Synchronous Output](#)

11.2 Working with Synchronous Output

With a dual channel setup it is easy to create two fill/key pairs for the left and right eye/camera during a stereo production. A special version of the Video Wall Distributor synchronously distributes one command to the two instances of the Viz Engine. For Viz Engine version 3.3 and later, it includes a built-in locking mechanism that makes sure both Viz Engines stay in sync, even if one of them drops a frame. This feature can be set On or Off by a simple command sent through the distributor.

This section contains information on the following topics:

- [Hardware Requirements](#)
- [Software Requirements](#)
- [Synchronous Output Configuration](#)
- [Video Wall Distributor](#)
- [To Configure a Machine with Two Graphics Cards](#)

11.2.1 Hardware Requirements

- HP Z800 machine or better
- 2 x NVIDIA Quadro FX 3800 or 2x NVIDIA Quadro FX 4800 (GPUs must be identical)
- Matrox X.mio2 video in- and output card

11.2.2 Software Requirements

- Viz Artist/Engine version 3.3 or later

11.2.3 Synchronous Output Configuration

The Viz Engine installer includes an option for dual channel support. Choosing this option generates desktop icons to start the configuration and the Viz Engine for channel 1 as well as for channel 2.

.....
Note: Viz Artist will only be available for channel 1 as it will always run on the first GPU.
.....

The configurations use one video input per channel and embedded audio on the channel. The table below shows the main differences in the configurations:

	Viz Engine 1	Viz Engine 2
Stereo Mode	LEFT_EYE	RIGHT_EYE
Video In A	Video1	Unused
Video In B	Unused	Video 1
Video In C+D	Unused	Unused
Clip A	Clip 1	Clip 1
Clip B	Clip 2	Clip 2
Video Out A	Fill	Unused

	Viz Engine 1	Viz Engine 2
Video Out B	Unused	Fill
Video Out C	Key	Unused
Video Out D	Unused	Key
Communication Port	6700	6800

Since this configuration puts an extra load on the Matrox card, it is important to use the available resources with care:

- In the video section of the scene switch off all unused layers
- Let the GPU do the color conversion.
The Matrox card itself is synced through the Viz Engine 1 instance.

It is important that only **one** display is active in the NVIDIA control panel. If you span the desktop across multiple GPUs, the affinity mask has no effect and both engines will render on GPU.

11.2.4 Video Wall Distributor

The Video Wall distributor listens to port 6100 as if it was a regular Viz Engine. The engines are connected through ports 6700 and 6800 respectively.

During startup the engines are not in sync; hence, you need to send the Viz command `RENDERER SET_VSYNC 1` for them to listen to each other. If one Viz Engine fails, `RENDERER SET_VSYNC 0` should be sent to the other renderer to allow it to run freely.

- `RENDERER*CURRENT_CAMERA*ZERO_PARALLAX_DIST SET` will set the distance of the zero parallax plane to the camera origin.
- `RENDERER*CURRENT_CAMERA*EYE_SEPARATION SET` sets the eye separation of the current camera.

These properties are also available for the individual cameras in all three layers.

11.2.5 To Configure a Machine with Two Graphics Cards

1. Install Viz Engine 3.3 or later and choose **Dual Channel** or **Viz Trio Box CG** setup.
2. From the Viz3 sub folder `ConfigExample/TrioOneBox` or `ConfigExample/DualChannel`, select the example Viz Config file that suits your desired video output format.
3. Create two copies of the selected Viz Config file and place them in your Viz3 directory and rename one to `VIZ-YOURHOSTNAME-0-0.cfg` and the other `VIZ-YOURHOSTNAME-1-0.cfg`.
4. Start Viz Config for both instances (channel 1 and channel 2) and enter settings for the Viz Graphics Hub (see [Database](#)) and enable Auto Log-in.
 - Auto log-in is needed as dual channel engines start without a UI.
 - For Viz Trio it is more a convenience factor, and not needed as such.
5. Start Viz Engine for channel 1 and then Viz Engine for channel 2.
 - Channel 1 signals are available on Matrox OutA (fill) and OutC (key).

- Channel 2 signals are available on Matrox OutB (fill) and Out D (key).

.....
Note: Viz Trio Box CG requires Viz Trio 2.9 or later and Media Sequencer 1.19 or later.
Viz Trio Box CG is a single channel setup where you have a program channel on the client machine in addition to your regular local Viz Engine preview.
.....

See Also

- [Viz Command Line Options](#)
- [Stereo Settings](#) and Stereoscopy best practices (see the [Viz Artist User Guide](#))
- [Setup of the output channels using two graphics cards](#) (see the [Viz Trio User Guide](#))

11.3 NVIDIA Driver Configuration

This section contains information on the following procedures:

- [To Configure NVIDIA Driver Settings for Viz Engine, Video mode](#)
- [To Configure NVIDIA Driver Settings for Viz Engine, VGA mode](#)
- [Vertical Sync](#)
- [To Configure the V-phase Settings when Synchronizing the Card](#)
- [To Configure Mosaic](#)
- [NVIDIA G-SYNC Card](#)

11.3.1 To Configure NVIDIA Driver Settings for Viz Engine, Video mode

.....
IMPORTANT! For maximum performance when running the Viz Engine in VGA mode, please refer to the procedure [To Configure NVIDIA Driver Settings for Viz Engine, VGA mode](#) below.
.....

1. Right-click the desktop and select the **NVIDIA Control Panel**.

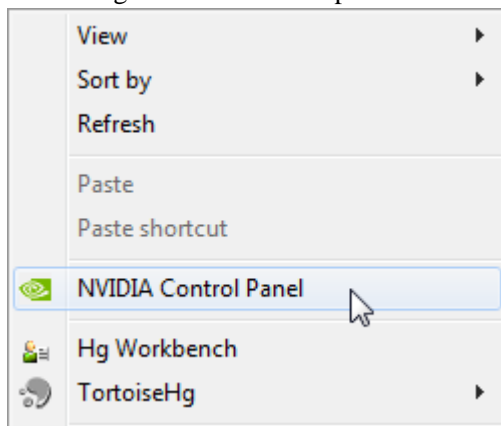

2. Click **Manage 3D settings**.

- [-] 3D Settings
 - ...Adjust image settings with preview
 - ...**Manage 3D settings**
 - ...Set PhysX Configuration
- [-] Display
 - ...Change resolution
 - ...Adjust desktop color settings
 - ...Rotate display
 - ...View HDCP status

3. In **Global Settings** select the Global presets option **Base Profile**

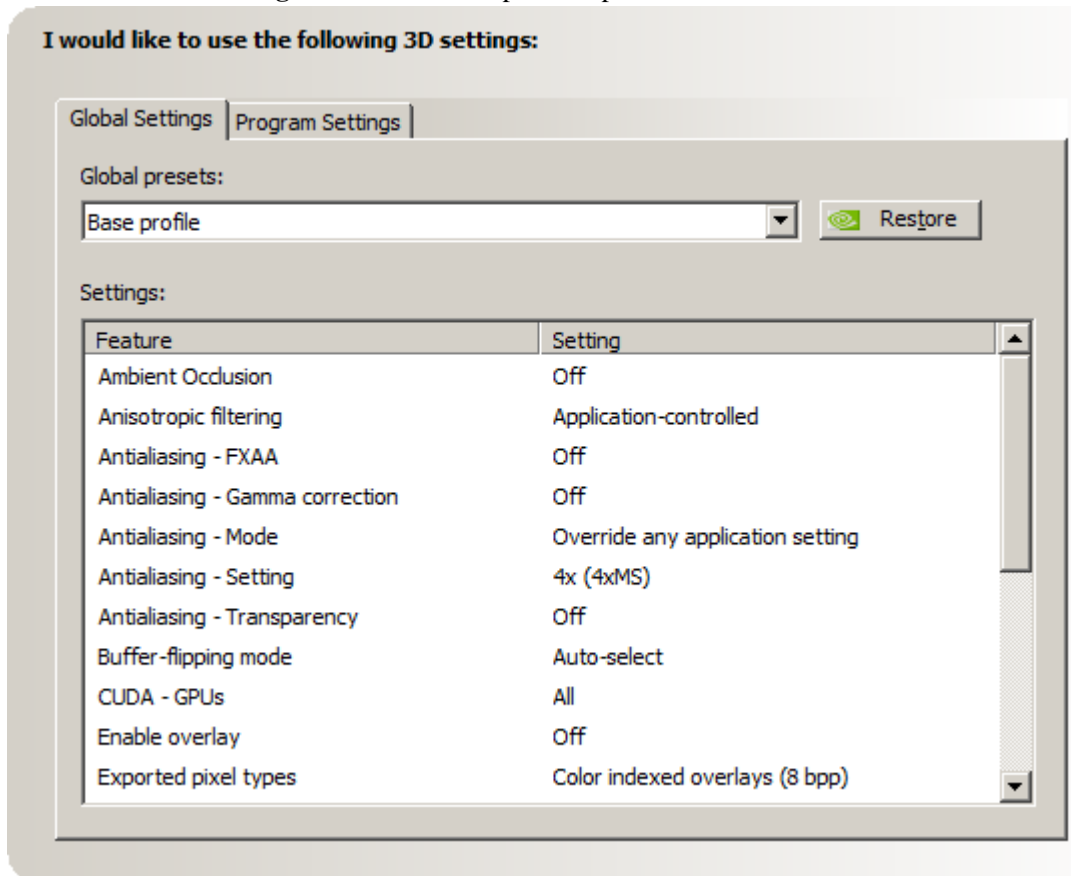

4. Set the following parameters:

- **Ambient Occlusion:** Off
- **Anisotropic filtering:** Application controlled
- **Antialiasing-Gamma correction:** Off
- **Antialiasing-FXAA:** Off
- **Antialiasing-Mode:** Override any application settings
- **Antialiasing-Setting:** 4x (4xMS)
- **Antialiasing-Transparency:** Off
- **Power management mode:** Prefer maximum performance
- **Vertical Sync:** Off (see **Vertical Sync** below)

5. In the **Global presets** drop down box select **Workstation App - Dynamic Streaming**.

6. Click on **Apply**.

11.3.2 To Configure NVIDIA Driver Settings for Viz Engine, VGA mode

For maximum performance when running the Viz Engine in VGA mode, follow the procedure [To Configure NVIDIA Driver Settings for Viz Engine, Video mode](#) outlined above, and observe the following changes:

1. In **Global Settings**, change the Global presets option to **3D App - Video Editing**
2. The parameter for **Vertical Sync** must be set to **On**

11.3.3 Vertical Sync

Notes for Vertical Sync:

- **Use the 3D application setting:** Use for Viz installations (running in Standard PC (VGA) mode) and for Video Wall setups where video is in use.
- **Off:** Used for Viz installations where video is in use (unless used for video walls).
- **Unified Back Buffer:** Must be disabled (Off) in any case. Note that this depends on the driver version used. Most recent drivers from NVIDIA already have this setting disabled.
- For Quadro FX 4500 SDI, and FX 5500 SDI boards the parameter `use_old_nv sdk` may need to be set to 1 in the Viz Config file, if stability issues encounter, on unsupported systems.

11.3.4 To Configure the V-phase Settings when Synchronizing the Card

1. Start Viz Config, or open the configuration from Viz Artist (Config button in the upper right corner)
2. Select [Video Output](#).
3. When using an NVIDIA SDI output option and synchronize on blackburst, use the following v-phase settings:
 - PAL: 606
 - NTSC: 509
 - 720p50: 743
 - 720p60: *not supported*
 - 720p60M: 736
 - 1080i50: 1113
 - 1080i60M: 1113
4. When synchronizing with SDI, leave the v-phase to 0

11.3.5 To Configure Mosaic

If setting up a Video Wall, please refer to the [Video Wall Configuration](#) chapter.

1. Right-click the desktop and select the **NVIDIA Control Panel**.
2. Click **Set up Mosaic**.
3. Tick the **Enable Mosaic** box.
4. Tick all required displays.
5. Set the **Refresh rate**.

6. Set the **Resolution (per display)**.

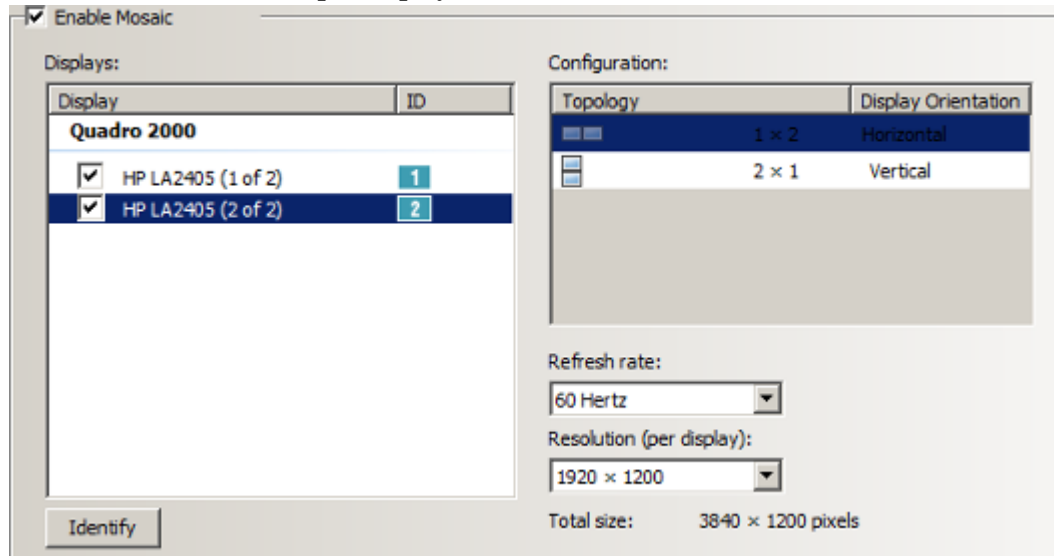

7. Click **Apply**.

8. Open Viz Config.

9. Click on **User Interface**.

10. Set **Screen Layout Mode** to **Mosaic Horizontal** or **Mosaic Vertical**.

11.3.6 NVIDIA G-SYNC Card

The G-SYNC card makes sure that all screens, which make up a Video Wall, are synchronized. When there are several Viz Engines in use, one is defined as the master and all the others as slaves.

Make sure that the G-Sync card firmware is version 4.0 (0x54 in the NVIDIA Control Panel (System information)). To check the current version download these files from <ftp.vizrt.com>:

- `start_update.bat`
- `NVGSyncUpdate.exe`

This section contains the following procedures:

- [To Check the Firmware Version](#)
- [To Install the Latest Firmware Version](#)
- [To Configure G-SYNC on one Viz Engine](#)
- [To Configure the G-SYNC Card on Viz Engine Slaves](#)
- [To Check the G-SYNC Status](#)
- [Genlock \(House Sync\)](#)

To Check the Firmware Version

- Double click the **start_update.bat** file:
 - If the output says **4.0 same version**, no action is required
 - If it shows an older version install the latest version

To Install the Latest Firmware Version

1. Close all applications, including the NVIDIA Control Panel.
2. Run *NVGSyncUpdate.exe -u*.
3. Restart the machine.
4. Check that the version is 4.0 (0x54 in the NVIDIA Control Panel (System information)).

To Configure G-SYNC on one Viz Engine

1. On Viz Engine, go to the NVIDIA control panel.

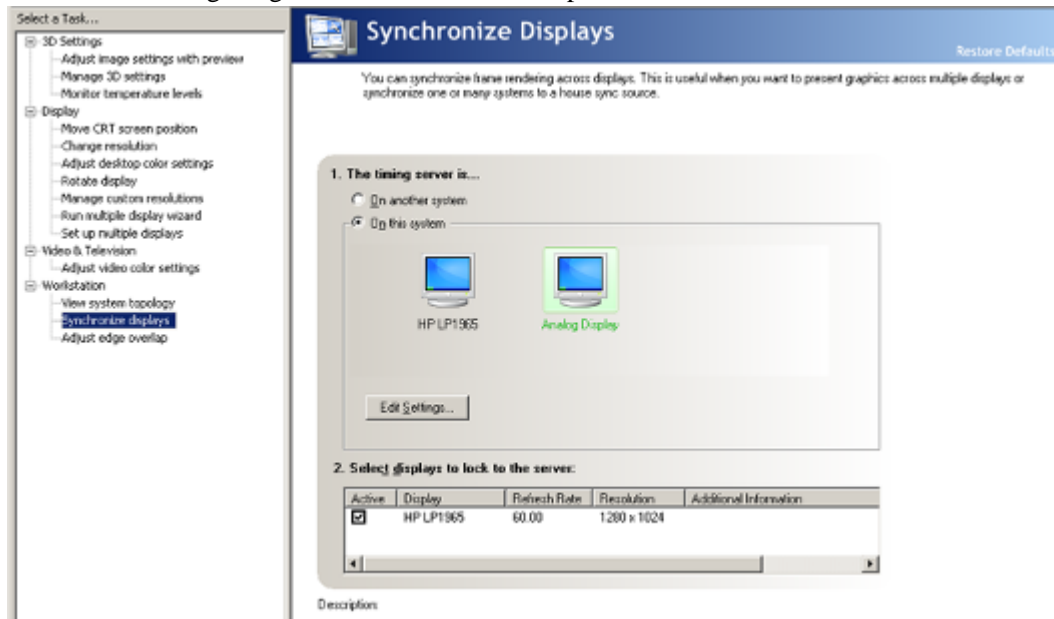

2. In **Workstation**, click **Synchronize displays**.
3. In **The timing server is...**, click **On this system**.
4. In **Select displays to lock to the server**, click each available display, in the field below, to make them active.

To Configure the G-SYNC Card on Viz Engine Slaves

Do this procedure on each Viz Engine slave.

1. On the Viz Engine slave, open the NVIDIA control panel.

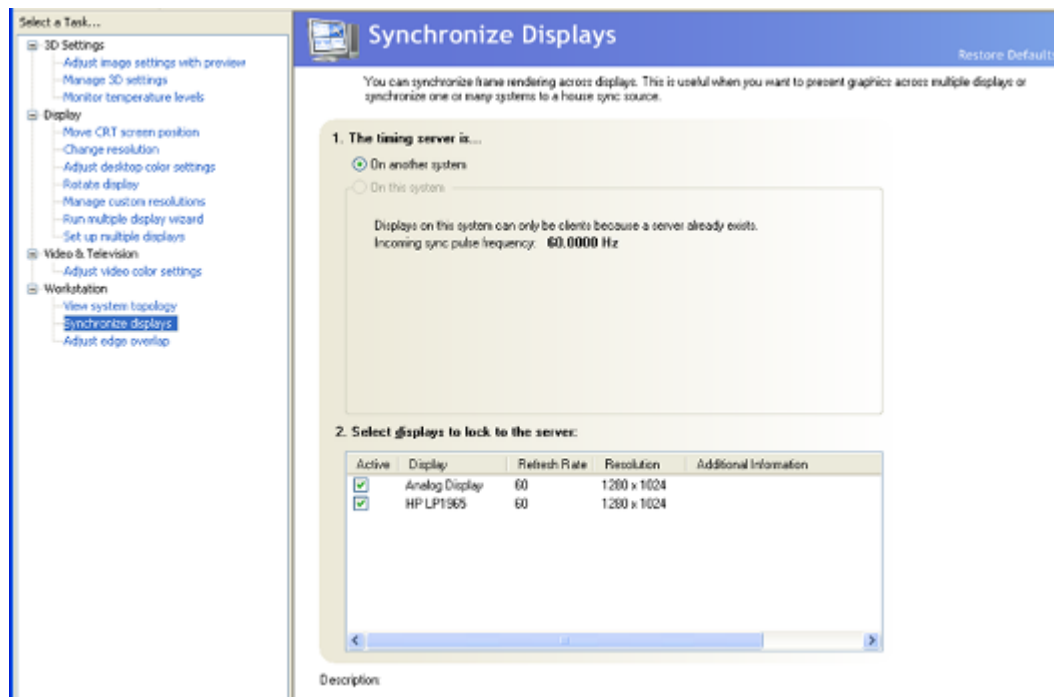

2. In **Workstation**, click **Synchronize displays**.
3. In **The timing server is...**, click **On another system**.
4. In **Select displays to lock to the server**, click each available display, in the field below, to make them active.

To Check the G-SYNC Status

1. On each machine, in turn, open the NVIDIA control panel.
2. In **Workstation**, click **View system topology**.
3. On the slave system, make sure that **Frame lock sync pulse is present** shows in the G-SYNC status portion on the lower part of the screen.

Genlock (House Sync)

There also the option to use a genlock (house sync) signal from the studio as an input to the G-SYNC card. In this case, once connected, check the signal in the **View system topology** screen, in **Workstation**.

House sync signal is not present (1) means that no external genlock is connected and that the pulse is generated internally. If the external genlock is not used, this message can be ignored.

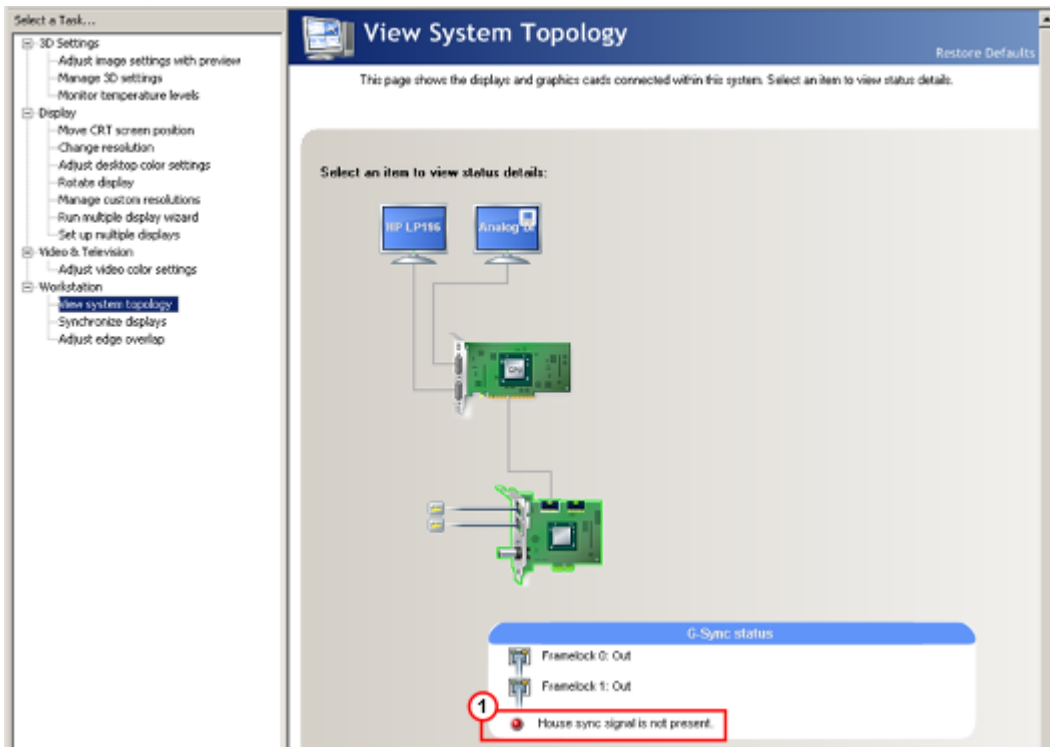

11.4 NVIDIA Driver History

This section lists all officially supported NVIDIA graphic boards and their recommended drivers. The listed drivers are used for both desktop and notebook graphic cards.

For NVIDIA SDI extension boards used in an **SDI** workflow, **firmware version 3.09** is required.

See Also

- [Video Wall Configuration](#)
- [NVIDIA Legacy Cards](#)
- [NVIDIA Driver Configuration](#)

11.4.1 NVIDIA Maxwell and Kepler Architecture Cards - Quadro Series

Viz Engine supports the following Maxwell and Kepler Architecture cards:

Card model	Card model (continued)
• Quadro M6000	• Quadro K2200
• Quadro M4000	• Quadro K2100M
• Quadro K6000	• Quadro K2000
• Quadro K5200	
• Quadro K5100M	• Grid K2
• Quadro K5000	• Quadro 5000
• Quadro K4200	• Quadro 4000
• Quadro K4000	• Quadro 2000

The following table lists Viz Engine versions and the corresponding NVIDIA driver version:

Viz Artist/Engine Version	Driver
3.8.3	368.86
3.8.2	361.91
3.8.1	353.82
3.8.0	347.25
3.6.4	341.21

12 Matrox Hardware

Viz Engine supports a wide range of Matrox products. This chapter provides an overview of the different Matrox video cards and dongles supported by Viz Engine, as well as providing their common installation procedures.

The Matrox X.mio series boards are used as Vizrt's HD, SD and 4K multi-channel video- and audio I/O solution. The original Matrox X.mio is considered legacy. There are currently three generations of the Matrox X.mio boards: The Matrox X.mio2 and X.mio2 plus, and Matrox X.mio3.

- **X.mio3** was introduced in 2015 and is supported by Viz Engine 3.8 and higher.
- **X.mio2 Plus** brought new features such as Matrox Control Engine (MCE) and advanced failsafe capabilities, compared to the X.mio2.
- **X.mio2** is mainly used for Virtual Studio due to low latency requirements. Since Viz Engine 3.8.2, the preferred video card for Virtual Studio solutions is the Matrox X.mio3 card.

This section contains information on the following topics:

- [Matrox X.mio3 IP](#)
- [Matrox X.mio3](#)
- [Matrox X.mio, X.mio2 and X.mio2 Plus](#)
- [DVE Performance with X.mio3, X.mio2 Plus and X.mio2 Systems](#)
- [Audio Cable Assignment](#)
- [Matrox DSX LE Series](#)
- [Matrox X.RIO](#)
- [Matrox X.Open](#)
- [Matrox Driver Installation](#)
- [Mixed Mode Video Support](#)
- [Supported Codecs](#)
- [Watchdog](#)
- [Configuration History for Matrox X.mio and DSX Series](#)
- [Troubleshooting Matrox Video Hardware](#)
- [DVE Performance](#)

12.1 Matrox X.mio3 IP

The Matrox X.mio3 IP video board was designed to help broadcast equipment manufacturers meet the challenges of the SDI to IP transition. It is a half-height, half-length PCIe card that offers multi-channel video I/O over 10 GbE with IP encapsulation of HD, 3G and UHD1 video. The card offers a total of four IP inputs and four IP outputs. The stream content conforms to the SMPTE 2022-6 specification.



The card contains two enhanced small form-factor pluggable (SFP+) slots, or "bays". The lower bay is **SFP A**, and hosts inputs and output channels 1 and 2. The upper bay houses **SFP B**, which hosts input and output channels 3 and 4. The board does not have any SDI inputs or outputs. There is one Mini-BNC connector used to connect the card to the house genlock signal.

Be aware that SFPs come in two flavors:

- Short range (SR, 850 nm), and
- Long range (LR, 1310 nm).

In general, a cable may only connect two SFPs of the same type. In addition, please be aware that the SFP should not be constantly switched in and out of the X.mio3 IP card, as the warranty on the card may be voided if this occurs more than 40 times.

12.1.1 Key features

- Dual SFP+ cages for a total of 4 video inputs and 4 video outputs
- IP and analog blackburst timing reference
- Guaranteed non-bursty packet transmission
- Onboard multi-channel Up/Down/Cross scaler
- Onboard multi-layer compositor

Matrox X.mio3 IP Configuration and IP Properties

The main video properties of the IP input channels are very similar to live input channels on a Matrox card. These properties are accessible in the [Video Input: Stream Input](#) section of Viz Configuration.

Fill and Key Channel Mapping

When an output channel uses the alpha channel, a key channel will be created. This will always be the next numbered output channel. The channel pair will always be on the same SFP:

- **SFP A:** Fill is on output 1, and key is on output 2
 - **SFP B:** Fill is on output 3, and key is on output 4
- Note that it is possible for a dual channel setup to use independent output channels on one SFP, for example 1 and 2. In this case, the **Use alpha** property must be disabled for both channels.

Default IP Properties

By default, the fields in the configuration file are hidden, at least when set to default values. To view the default values, activate verbose mode by setting `VerboseConfig = 1` in the configuration file. Then launch and quit Viz Artist, in order to rewrite the Viz configuration.

Default source IP settings on output:

```
Output 1 = 10.10.10.31, port 48
Output 2 = 10.10.10.31, port 56
Output 3 = 10.10.10.33, port 48
Output 3 = 10.10.10.33, port 56
```

Default destination IP settings on output:

```
Output 1 = 10.10.10.51, port 48
Output 2 = 10.10.10.51, port 56
Output 3 = 10.10.10.53, port 48
Output 3 = 10.10.10.53, port 56
```

Default source IP settings for input channels:

```
Input 1 = 224.10.10.31, port 48
Input 2 = 224.10.10.31, port 56
Input 3 = 224.10.10.33, port 48
Input 3 = 224.10.10.33, port 56
```

Here are the default IP properties for Output channel 1 as shown in the config file:

```
Matrox0.VideoOut1.SrcAddress = 10.10.10.31
Matrox0.VideoOut1.SrcUdpPort = 48
Matrox0.VideoOut1.DstAddress = 224.10.10.31
Matrox0.VideoOut1.DstUdpPort = 48
```

Here are the default properties for IP input channel 1:

```
Matrox0.IpIn1.SrcAddress = 224.10.10.31
Matrox0.IpIn1.SrcUdpPort = 48
```

Change IP Properties

Although the IP properties may be changed by editing the configuration file directly, the IP address and port numbers can also be set via the command line interface. Because channel numbering is zero-based here, **Output Channel 1** is referred to as `VIDEOOUT_0`.

To change the destination address of the output channels:

```
MAIN*CONFIGURATION*MATROX*VIDEOOUT_x*DSTADDRESS SET xxx.xxx.xxx.xxx
MAIN*CONFIGURATION*MATROX*VIDEOOUT_x*DSTUDPPORT SET xxxxxx
```

To change the source address of the output channels:

```
MAIN*CONFIGURATION*MATROX*VIDEOOUT_x*SRCADDRESS SET xxx.xxx.xxx.xxx
MAIN*CONFIGURATION*MATROX*VIDEOOUT_x*SRCUDPPORT SET xxxxxx
```

To change the source address of the input channels:

```
MAIN*CONFIGURATION*CHANNELS*STREAMIN_x*SRCADDRESS SET xxx.xxx.xxx.
xxx
MAIN*CONFIGURATION*CHANNELS*STREAMIN_x*SRCUDPPORT SET xxxxxx
```

The current values can be queried using these commands:

```
MAIN*CONFIGURATION*MATROX*VIDEOOUT_x*DSTADDRESS GET
MAIN*CONFIGURATION*MATROX*VIDEOOUT_x*DSTUDPPORT GET
MAIN*CONFIGURATION*MATROX*VIDEOOUT_x*SRCADDRESS GET
MAIN*CONFIGURATION*MATROX*VIDEOOUT_x*SRCUDPPORT GET
MAIN*CONFIGURATION*CHANNELS*STREAMIN_x*SRCADDRESS GET
MAIN*CONFIGURATION*CHANNELS*STREAMIN_x*SRCUDPPORT GET
```

12.1.2 X.mio3 IP Command Examples

Set the source address of input channel 4. Because channel numbering is zero-based here, **IP Input Channel 4** is referred to as STREAMIN_3.

```
MAIN*CONFIGURATION*CHANNELS*STREAMIN_3*SRCADDRESS SET 224.10.10.34
```

Set the source UDP port of input channel 4:

```
MAIN*CONFIGURATION*CHANNELS*STREAMIN_3*SRCUDPPORT SET 9004
```

Query the destination properties of output 1, fill

```
> MAIN*CONFIGURATION*MATROX*VIDEOOUT_0*DSTADDRESS GET
< 224.10.10.102
> MAIN*CONFIGURATION*MATROX*VIDEOOUT_0*DSTUDPPORT GET
< 20000
```

Query the destination properties of the key channel associated with output 1:

```
> MAIN*CONFIGURATION*MATROX*VIDEOOUT_1*DSTADDRESS GET
< 224.10.10.104
> MAIN*CONFIGURATION*MATROX*VIDEOOUT_1*DSTUDPPORT GET
< 20000
```

12.2 Matrox X.mio3

This section first gives an overview of the Matrox X.mio3 video cards, then describes the details specific to the full height [X.mio3 FH](#) and low profile [X.mio3 LP](#) versions of the card. The [Matrox X.mio3 IP](#) board is discussed in a separate section.

In this section:

- [Matrox X.mio3 Overview](#)
- [X.mio3 FH](#)
 - [X.mio3 Connector Mapping Reference](#)
- [X.mio3 I/O Port Configuration](#)
- [Viz Engine Matrox Video Mapping Configuration](#)
- [To Upgrade X.mio3 Class and Firmware](#)
- [X.mio3 AES Audio Kit](#)

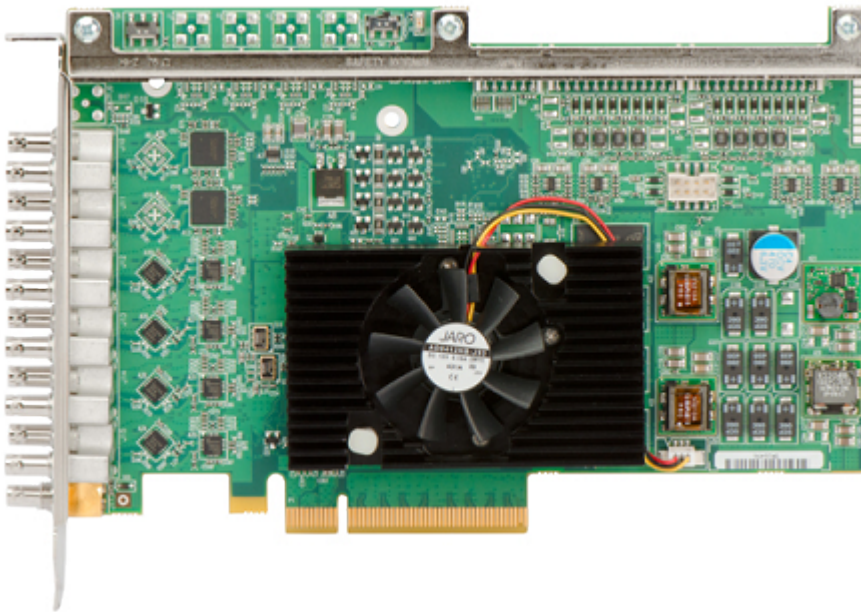

12.2.1 Matrox X.mio3 Overview

The X.mio3 can be ordered in two configurations: FH (full height, 12 physical HD-BNC connectors, plus one connector for sync) and LP (low profile, 8 physical HD-BNC Connectors, plus one connector for sync). Both are half length PCI express Gen2 x8 cards.

- X.mio3FH (Full Height, half length) with up to 12 I/O ports, SD to 4K capable. This card can be ordered with 6, 8 or X2 (12) I/O. 8 ports are hardwired through relays: 4 ins to 4 outs. Model /6 means 6 I/Os are available, model /8 8 I/Os. Model X2 (12 ports) has 4 freely configurable ports. There can be maximum 8 I/Os of one type (either in or out) enabled on a card.
- X.mio3LP (Low Profile, half length) with up to 8 I/O ports, SD to 4K capable.
- The I/O ports are configurable. This means that for instance the X.mio3 model /8 can be configured to have from 8/0 (e.g. 8 channels in, zero channels out) to 0/8 (zero channels in, 8channels out) or any mix between such 1/7, 4/4 and so on.

- One connector is reserved for a reference signal (sync) marked as REF.
The default card is an X.mio3/6/100, meaning X.mio3 FH with 6 connectors class 100. The class 100 can not play any video clips and upgrade to class 500 is required to enable both SD and HD clip playback. For Apple ProRes support, the class 550 is needed.

The I/O connectors for the X.mio3 are of the Mini-BNC (also called HD-BNC) type. The use of cable converters from Mini-BNC to BNC may be required.

The X.mio3 cards can be combined with the AES Audio Kit for 16 AES audio channels In/Out, see [X.mio3 AES Audio Kit](#).



12.2.2 X.mio3 FH

X.mio3 FH provides multichannel SDI IO with hardware based video processing in a full-height, half-length PCI express card with 13 physical HD-BNC connectors. This card provides up to 12 reconfigurable I/Os, from SD to 4K, one connector is reserved for sync. Support for AES/EBU, LTC and GPIO provide for versatile connectivity. The multi-channel hardware processing accelerates compute-intensive operations including motion-adaptive de-interlacing, up/down/cross scaling and mixing/compositing for all resolutions, including 4K.

Key features:

- Half-length PCI express card
- Re-configurable IO that can support up to 12 SDI IO
- Frame synchronizers
- VANC and HANC support for each input and output
- Analog black burst reference input (tri-level or bi-level)
- On-board multi-channel MADI (Motion Adaptive De-Interlacer)
- On-board multi-channel Up/Down/Cross scaler
- On-board multilayer compositor
- Automatic video relay bypass
- Live zero-frame delay video and audio mixers
- Up to 16 channels of AES/EBU inputs and outputs
- Up to 8 LTC inputs and outputs
- RS422 control
- Single slot all inclusive option

.IMPORTANT! Not all X.mio3 hardware features are supported by Viz.Engine. Features..... available depends on drivers, SDK and Engine versions in use.

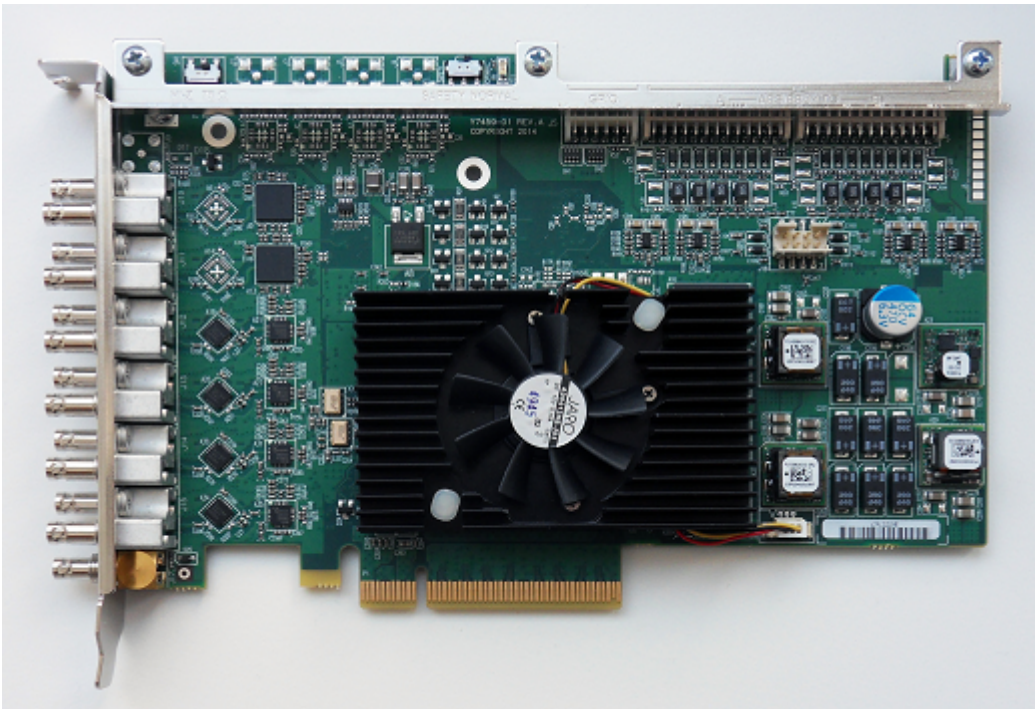

X.mio3 LP

Matrox X.mio3 LP is a low-profile, half-length PCIe card with up to eight reconfigurable SDI I/Os from SD to 4K.



Key features

- Low profile, half-length PCI-e card
- Re-configurable I/O that can support up to 8 SDI inputs or outputs
- Frame synchronizers
- VANC and HANC support for each input and output
- Analog black burst reference input (tri-level or bi-level)
- On-board multi-channel MADI (Motion Adaptive De-Interlacer)
- On-board multi-channel Up/Down/Cross scaler
- On-board multilayer compositor
- Automatic video relay bypass (optional)

- Live zero-frame delay video and audio mixer

.....
IMPORTANT! Not all X.mio3 hardware features are supported by Viz Engine. Features available depends on drivers, SDK and Engine versions in use.

The X.mio3 LP models are: /4, /6, /8 - corresponding to the number of I/O port the configuration supports.

X.mio3 Connector Mapping Reference

This section is a reference for X.mio3 connector mappings.

Upgrades and firmware setup of I/O mapping should be done by Vizrt or a qualified technician.

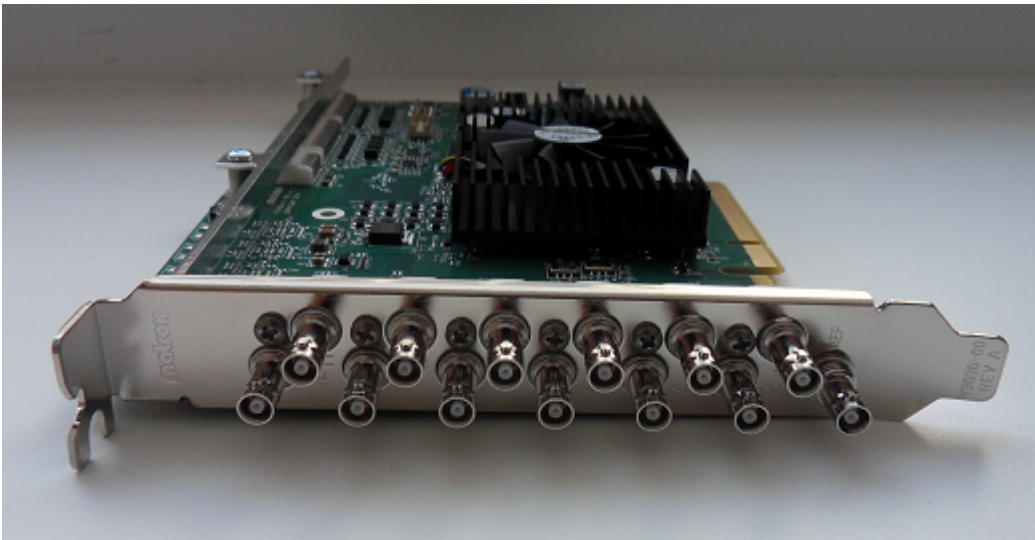

The X.mio3 connectors are labeled 1 through 12 (plus one connector for sync), 8 connectors for the LP (low profile) card. As explained, the connectors can be configured for in or out and with various capabilities for clip playback depending on class - with possibilities for firmware class upgrades.

.....
IMPORTANT! There can be maximum 8 ports of the same type (either in or out), this restriction also applies to the model x2 that has 12 connectors.

Connectors 1,3,5,7 will always be reserved for **input**, connectors 2,4,6,8 for **output**. Hence, if the Watchdog is active port 1 (in) will go to port 2 (out) with relay, port 3 (in) to port 4(out) and so on.

The x2 model can as mentioned only have 8 I/Os of the same type; 8in - 4out or 4in - 8out.

To configure the X.mio3 card for usage:

- Make sure that the card has the required mix of inputs and outputs required for the intended usage, for instance to satisfy fill, key, full-screen graphics requirements. This is done, if required, with the `mvConnectorConfig.exe` utility described in [X.mio3 I/O Port Configuration](#).
- Map the I/Os from step 1 above to the Viz Video channels using the Viz Engine Configuration utility. This is mostly the same procedure for X.mio3 as for previous Matrox cards, see [Viz Engine Matrox Video Mapping Configuration](#).

12.2.3 X.mio3 I/O Port Configuration

Normally the I/O ports are pre-configured when delivered from Vizrt. If the I/O configuration needs to be changed, the Matrox command-line utility `mvConnectorConfig.exe` normally found in

```
C:\Program Files\Matrox DSX.utils\drivers\mvConnectorConfig.exe
```

must be used. `mvConnectorConfig.exe` can be called from the command prompt without options to get a helpful usage message. To configure all X.mio3 cards in a system to use 4 inputs and 2 outputs the syntax is:

```
C:\Program Files\Matrox DSX.utils\drivers\mvConnectorConfig.exe -4  
in2out
```

To configure 6 outputs and no inputs the syntax is:

```
C:\Program Files\Matrox DSX.utils\drivers\mvConnectorConfig.exe -0  
in6out
```

and so on for the various I/O possibilities.

The computer should be stable with low load and no Viz programs running when using the configuration utility. Never interrupt a firmware upgrade. After making changes to the Matrox I/O configuration, the computer must be re-started with a complete power off.

12.2.4 Viz Engine Matrox Video Mapping Configuration

Open **VizConfiguration** > **Matrox** to configure the Matrox video channel mapping and mapping type.

The Viz video inputs are named alphabetically and limited to the number of available I/O channels the system has. The number in parenthesis indicates which channel is being used for fill and key. If you do not need a key signal in the output, de-select the **Key > Contains Alpha** option to make the I/O channel available for other usages. Example configuration:

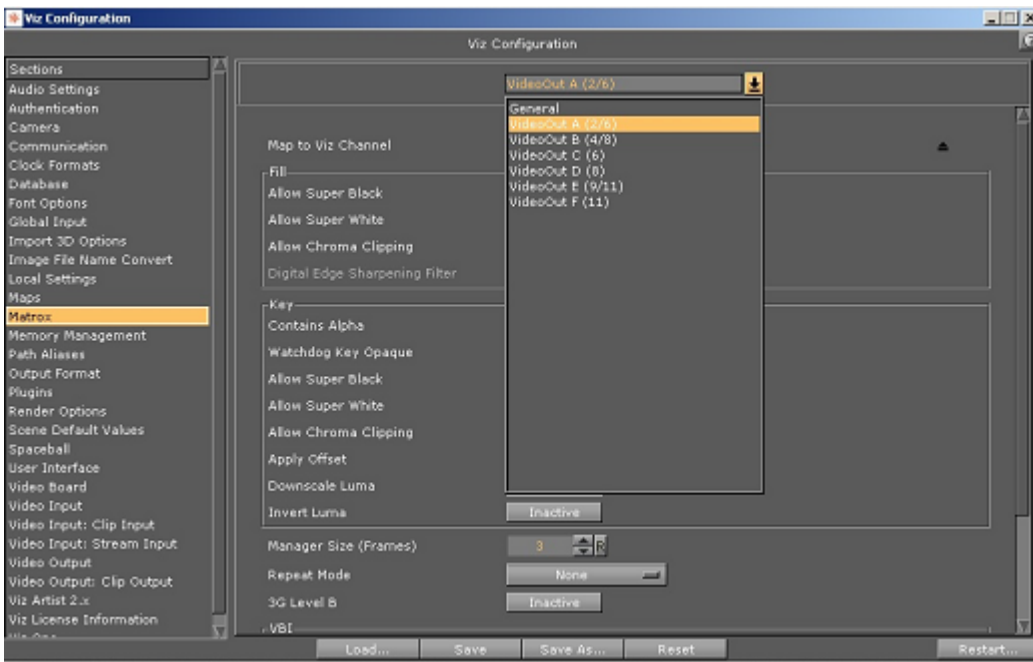

In the example above, the X.mio3 card is configured with 6 outputs (named **VideoOut A** to **F**) and no inputs. The numbers within the trailing parentheses reflect which IO-channel is being used for fill and key, respectively. This means **VideoOut A** uses IO-channel 2 for fill and IO 6 for key, **VideoOut B** uses IO 4 for fill, IO 8 for key, while **VideoOut C** only has fill using IO 6, and so on.

Navigate to **Config > Matrox > General** for an overview showing which I/O channels are used for fill and key, as illustrated in the **Board Info** section of the screenshot below:

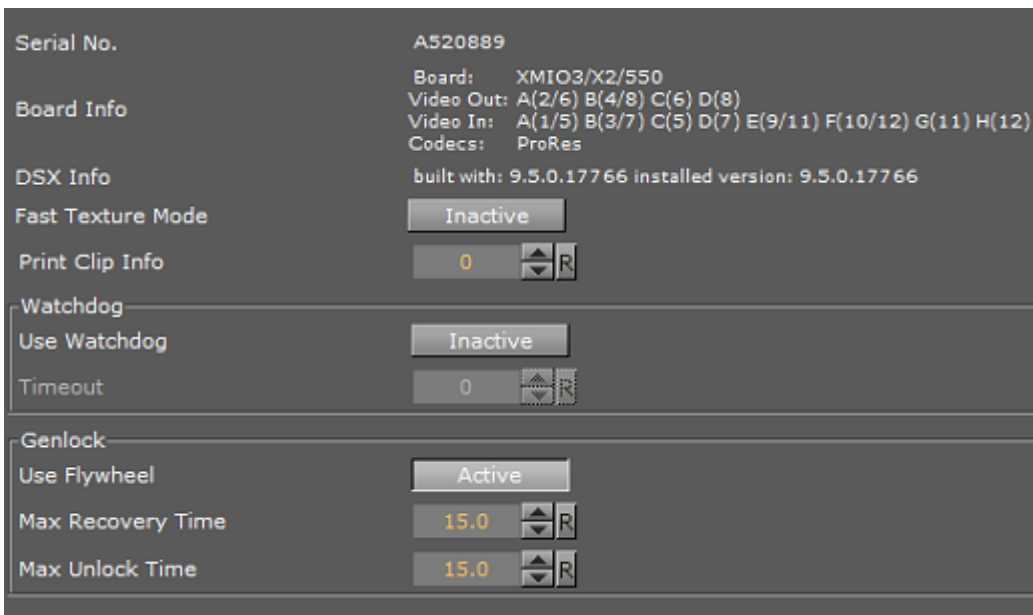

12.2.5 To Upgrade X.mio3 Class and Firmware

To upgrade your X.mio3 card, for example to enable more IO-ports or a codec upgrade for HD-Clipback, you must use the mvDongleUpdater.exe update utility with your Vizrt supplied license upgrade file <filename>.OPT. This utility is installed with the Matrox driver package and will normally be installed to

```
C:\Program Files\Programs\Matrox DSK.utils\drivers\mvDongleUpdater.exe
```

To upgrade the card use this syntax:

```
C:\Program Files\Matrox DSX.utils\drivers\mvDongleUpdater.exe upgrade -sn="SerialNumberofthecard" -f="Path to the upgrade file"
```

The command above must be run from a Windows command line window (Windows-button > cmd > Enter).

The Matrox [X.info](#) utility is used to display information about the card class, how the Input and Outputs are configured, serial number and more. This utility can normally be started from the Windows taskbar. A typical information window would be:

12.2.6 X.mio3 AES Audio Kit

X.mio3 Class 100

X.mio3 Class 550

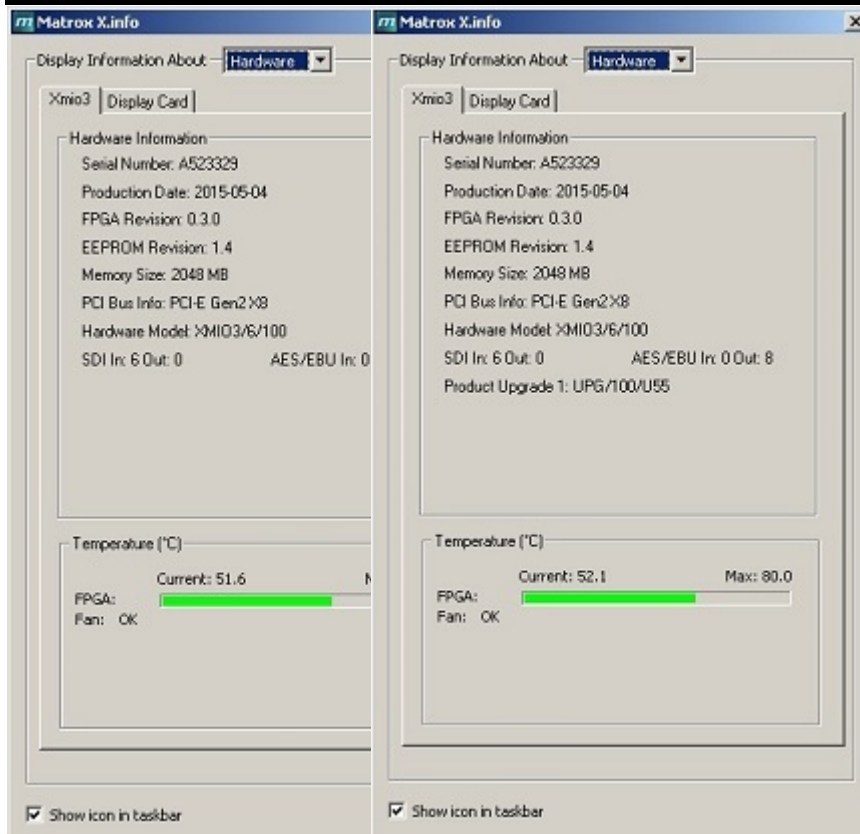

The X.mio3 AES Audio Kit connects to the X.mio3 card internally and takes up one slot as indicated in the picture below:

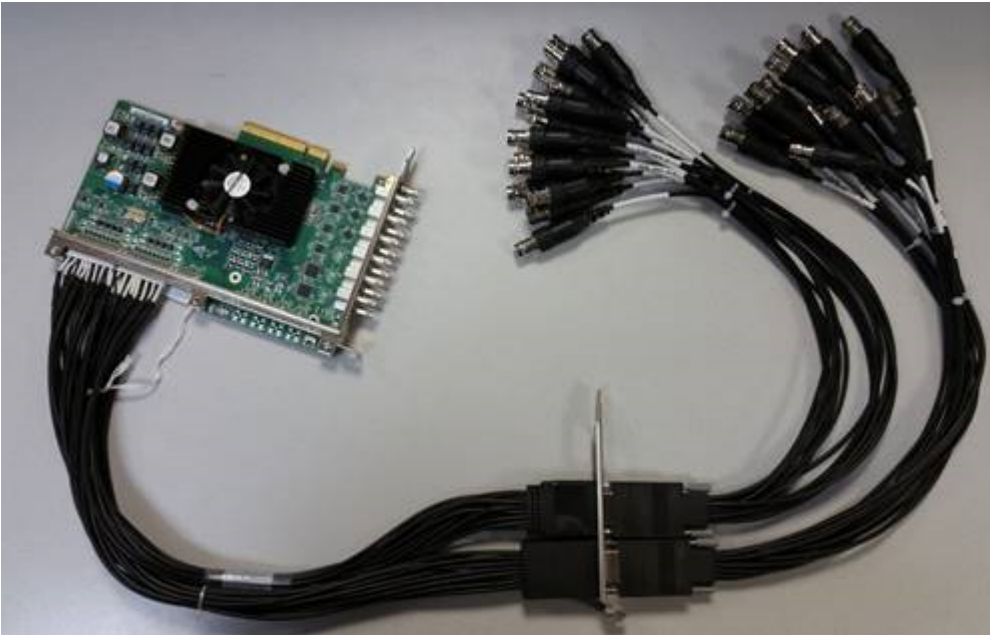

The kit contains:

- 2 internal cables with bracket
- 2 external cables, each cable has:
 - 8 AES/EBU in and 8 AES/EBU out
 - 4 LTC in and 4 LTC out
- Total 16 AES/EBU in and out
- Total 8 LTC in and out

12.3 Matrox X.mio, X.mio2 and X.mio2 Plus

This section contains information on the following topics:

- [X.mio2 and X.mio2 Plus Cables and Connectors](#)
- [X.mio2 Standard Cable Configuration](#)
 - [Viz Engine Single Channel Configuration](#)
 - [Dual Channel Configuration](#)
 - [Trio Box CG/Viz Trio OneBox Configuration](#)
- [Breakout Cables and Connectors](#)
 - [Video Cables for X.mio Series](#)
 - [Video Connectors for X.mio2 Plus](#)
 - [Video Connectors for X.mio2](#)
 - [Video Connectors for X.mio](#)
 - [Audio Connectors for X.mio2 and 2 Plus](#)
 - [Audio Connectors for X.mio](#)
- [Video Cable Assignment](#)

- Audio-extension Card
 - To Connect the Audio-extension Card to the Video Board
 - To Remove the Audio-extension Card Back-end
- X.mio2 License Upgrade
 - To Generate a Matrox Dongle Information File (.MDIF)
 - To Upgrade with a Matrox Dongle Upgrade File (.MDUF)
 - To Reset to Factory Settings



12.3.1 X.mio2 and X.mio2 Plus Cables and Connectors

The connectors for X.mio2 and X.mio2 Plus are:

- PCIe board compliant to PCIe 2.0 in x8 or x16 slot
- x2 or x4 SDI video inputs in SD and HD
- x4 SDI video outputs in SD and HD
- x16 In / x32 Out, unbalanced AES/EBU audio

Because of the large number of I/O connections, the X.mio2 and X.mio2 Plus boards are equipped with Sub-D connectors. A breakout-cable or rack mountable Break Out Box (BOB), which translates the Sub-D connectors to regular connectors/plugs, is included for every machine.

The connectors for X.mio are:

- 133 MHz PCI-X board compliant to PCI-X standards 1.0b and 2.0
- x2 SDI video inputs in SD and HD
- x4 SDI video outputs in SD and HD
- x8 In / x16 Out, balanced XLR AES/EBU audio
- x16 Embedded Audio I/O Channels per SDI Stream

12.3.2 X.mio2 Standard Cable Configuration

This section contains the standard configuration, set in the in the Viz Configuration, to cable a Viz Engine to the correct SDI IN and OUT connectors.

Viz Engine Single Channel Configuration

- SDI OUT A: mapped to Program Fill
- SDI OUT C/KEY: mapped to Program Key
- SDI OUT B: mapped to Preview Fill
- SDI OUT D/KEY: mapped to Preview Key
- SDI IN A: mapped to Video1
- SDI IN B/KEY: mapped to Video2, and so on

Dual Channel Configuration

A Viz Engine configured as Dual Channel utilizes two graphics cards and runs two instances of the Engine on a single computer. When running a Dual Channel setup, video inputs are hardware resources on the Matrox board that can not be shared. If one input for both Viz Engine channels is required, split the signal and apply it to the two video input connectors. Each Matrox video input can only be mapped in one Viz Engine instance and has to be set to unused in the other instance.

- **Channel 1:**
 - SDI OUT A: mapped to Program Fill
 - SDI OUT C/KEY: mapped to Program Key
 - SDI IN A: mapped to Video1 for the first channel
 - SDI IN B/KEY: unused for the first channel, and so on.
- **Channel 2:**
 - SDI OUT B: mapped to Program Fill
 - SDI OUT D/KEY: mapped to Program Key
 - SDI IN A: unused for the second channel
 - SDI IN B/KEY: mapped to Video1 for the second channel, and so on

.....
IMPORTANT! Both Viz Engines must be set to the same genlock setting.
.....

Trio Box CG/Viz Trio OneBox Configuration

- **Program:**
 - SDI Out A: mapped to Fill
 - SDI OUT C/KEY: mapped to Key
 - SDI IN A: mapped to Video1
 - SDI IN B/KEY: mapped to Video2, and so on.
- **Preview:**
 - SDI Out B: mapped to Fill
 - SDI OUT D/KEY: mapped to Key
 - no Inputs are mapped by default

12.3.3 Breakout Cables and Connectors

A Breakout Box (BOB) is often used for Viz Engine solutions that need to be rewired in regular intervals. The 1U Rack unit chassis is designed to fit into a standard 19" rack.



This section contains information on the following topics:

Video Cables for X.mio Series

This image shows the cables responsible for transmitting any video related signals to and from the X.mio2 Plus board.



Video Connectors for X.mio2 Plus

The front panel of the X.mio2 Plus breakout box provides the user with 8 or 9 standard BNC connectors.

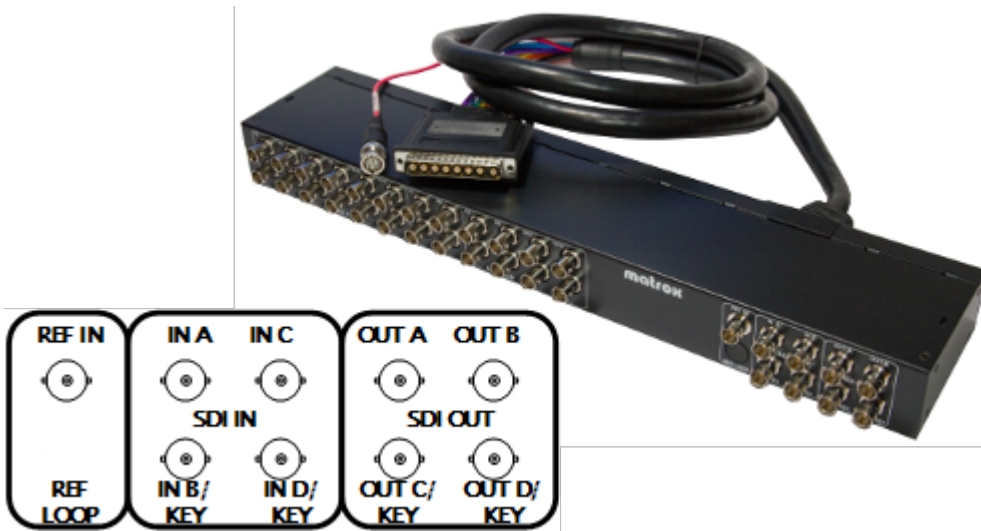

- x2 or x4 HD/SD SDI In
- x4 HD/SD SDI Out
- x1 Analogue Ref In

Video Connectors for X.mio2

The front panel of the X.mio2/2 Plus breakout box provides the user with 8 or 10 standard BNC connectors.

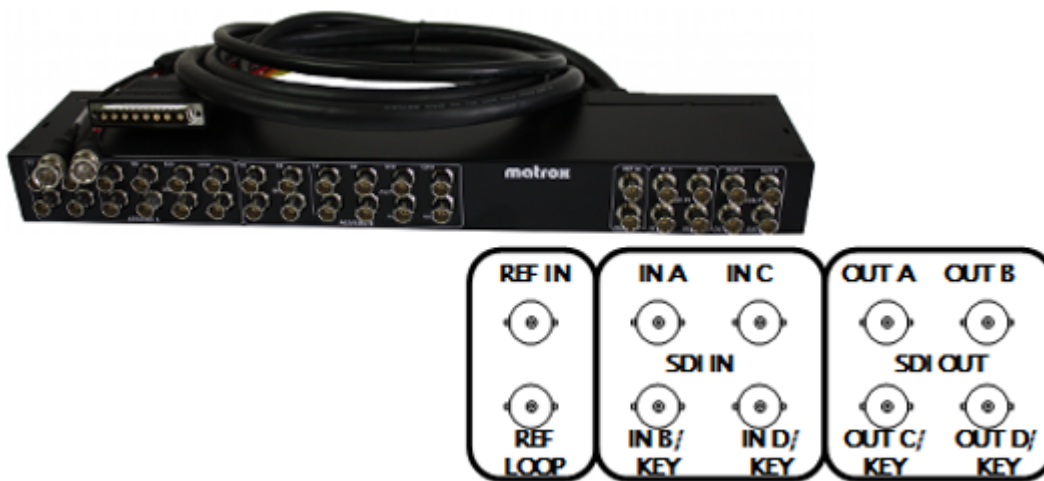

- x2 or x4 HD/SD SDI In
- x4 HD/SD SDI Out
- x1 Analogue REF IN
- x1 Analogue REF LOOP

.....
IMPORTANT! When using the REF IN connector on the Matrox X.mio2 board for synchronization, the REF LOOP connector must be terminated with a 75 Ohm resistor unless it is being used to loop an incoming Genlock signal.

Video Connectors for X.mio

The front panel of the X.mio breakout box provides the user with 8 standard BNC connectors.



- x2 HD/SD SDI In
- x4 HD/SD SDI Out
- x1 Analogue REF IN
- x1 Analogue REF LOOP

.....
IMPORTANT! When using the Ref. In connector on the Matrox X.mio board for synchronization, the Ref. Out Loop connector must be terminated with a 75 Ohm resistor unless it is being used to loop an incoming Genlock signal.

Audio Connectors for X.mio2 and 2 Plus

On the X.mio2/2 Plus breakout box, each of the two audio bays, A and B, consists of four female BNC audio input channels and of eight female BNC audio output channels.

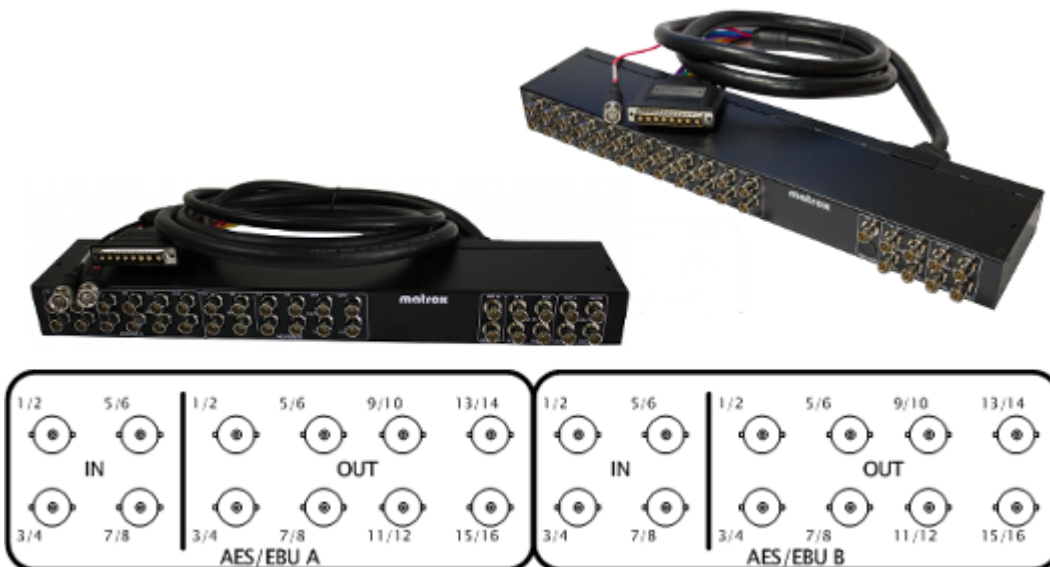

~~·Note: Bay cables are not included:.....~~

On the backside of each breakout box there are two connectors labeled AUDIO-A and AUDIO-B. The included cables are used to connect the corresponding plugs of the X.mio series to the computer.

Audio Connectors for X.mio

The front side of the X.mio breakout box hosts various audio in- and outputs. Each of the two audio bays, A and B, consists of two female AES/EBU audio input channels and of four male AES/EBU audio output channels.

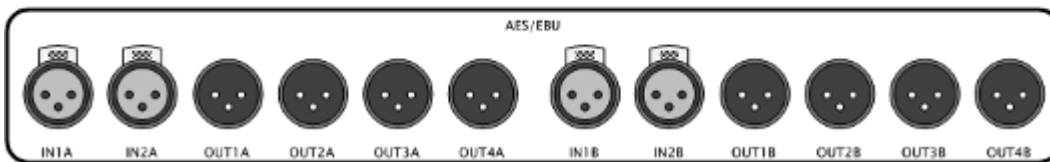

12.3.4 Video Cable Assignment

Connect the relevant video input(s) and output(s), and the reference signal(s) as per the labels attached to each cable.

A reference signal can be attached to the reference input connector **ANALOG REF IN**, which can be fed with any analogue Genlock signal, such as a black burst or Tri-level as required.

If the reference signal used for synchronization is relayed from a Matrox X.mio and X.mio2 to a graphics card, make sure to check that all internal connections between the graphics card and its SDI extension are connected correctly, and that the extension is correctly supplied with power.

When the **ANALOG REF IN** connector is used with a Matrox X.mio or X.mio2 board for synchronization, the **ANALOG REF LOOP OUT** connector must be terminated with a 75 Ohm resistor unless it is being used to loop an incoming Genlock signal. The ANALOG REF LOOP OUT for the X.mio2 Plus is terminated by default, and so only supports REF IN on the actual board.

12.3.5 Audio-extension Card

The audio-extension card and audio cables are part of the X.mio series break-out box or the X.mio series cable kit (that comes with the X.mio series boards), and needs to be installed when AES/EBU audio support is required. The card is an extension for the connectors, and does not provide any extra functionality. For installations that require embedded audio, or no audio at all, this extension is not required.



.....
IMPORTANT! The Matrox audio-extension card only supports digital audio.
.....

By default, the audio-extension card will consume one additional free slot on the motherboard. The card is supplied with the Matrox X.mio series boards in terms of power and data.

In some cases, the design of the audio-extension card makes it hard to mount it at a location with an underlying PCIe slot. Therefore, it is an option to remove the back-end from the Audio-extension Card instead of using another PCI or PCI-X slot. However, it is in most cases possible to mount the extension card in any slot in the machine, unrelated to the underlying slot's design, without removing its back-end.

Removing the back-end of the extension card will free any connection to the motherboard. As a result, it may react more sensitively to transportation and tension introduced by the external audio cables connected to it. Therefore, the above-mentioned procedure should only be applied to machines residing in stable environments like a dedicated machine room. Do not apply these instructions to machines intended to be used for outside broadcasting or equipment that will be moved around a lot.

To Connect the Audio-extension Card to the Video Board

.....
IMPORTANT! The Matrox audio-extension card only supports digital audio.
.....

1. Locate the connectors on the audio-extension card labeled A and B.

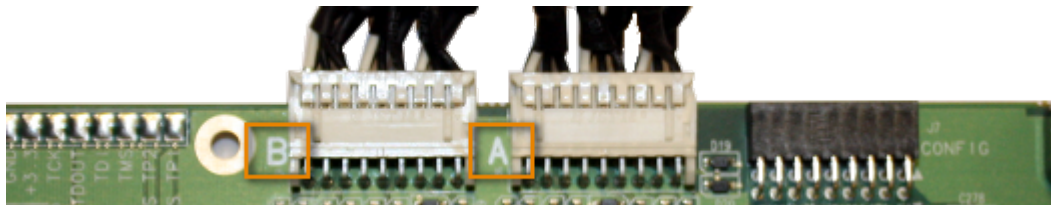

2. Locate the connectors on the video board labeled A and B.
3. Use the cables to connect A on the audio-extension card to A on the video board, and do the same for the B connectors.

To Remove the Audio-extension Card Back-end

1. Locate the audio-extension card's weak spots

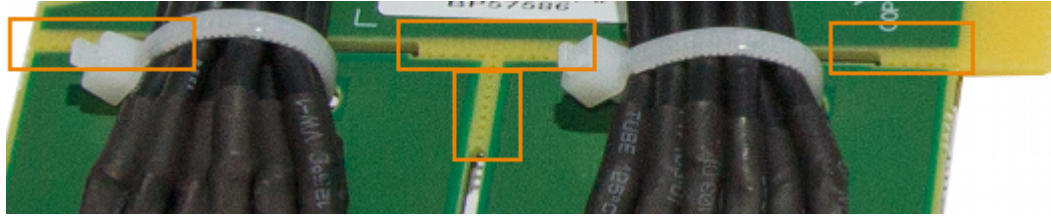

2. Carefully break the connections.

.....
Caution: Do not break the weak spots that hold the two remaining pieces together.
.....

12.3.6 X.mio2 License Upgrade

The Matrox X.mio2 and X.mio2 Plus boards include all SD codecs except D10 Television/D12 Television. These two boards can be upgraded to any higher class by a license upgrade. To do this, use the Matrox [X.info](#) utility.

To upgrade a video board to a higher class, it is necessary to generate a Matrox Dongle Information File (.MDIF), and then upgrade with a Matrox Dongle Upgrade File (.MDUF). It is also possible to reset to factory settings at any time.

The X.mio2 Plus board video inputs can also be upgraded from 2 to 4.

.....
Note: Driver versions older than 4.0.0-126 do not support the upgrade and revert features.
.....

To Generate a Matrox Dongle Information File (.MDIF)

1. Open the Matrox [X.info](#) utility on the Windows taskbar.
2. Select Hardware, and click the Upgrade Model button on the right.
3. From the appearing menu, choose Generate Matrox Dongle Information File (.MDIF).
4. Select to save the file to a specified location.
5. Once the file is created a confirmation dialog box will appear.
6. Click OK to dismiss the confirmation dialog box.
7. Locate the file and send it to your local Vizrt representative (to find the local Vizrt customer support team, please visit www.vizrt.com).
 - Once the request to purchase an upgrade has been sent, an MDUF file will be sent in return from Vizrt.

To Upgrade with a Matrox Dongle Upgrade File (.MDUF)

1. Open the Matrox [X.info](#) utility on the Windows taskbar.
2. Select Hardware, and click the Upgrade Model button on the right.
3. From the appearing menu, choose Upgrade Board from Matrox Dongle Upgrade File (.MDUF).
4. Click Browse to locate and select the .MDUF file to start the upgrade process.
5. Restart the machine for the changes to take effect.

To Reset to Factory Settings

1. Open the Matrox [X.info](#) utility on the Windows taskbar.
2. Select Hardware, and click the Upgrade Model button on the right.
3. From the appearing menu, choose Reset to Factory Settings.
4. Restart the machine for the changes to take effect.

12.4 DVE Performance with X.mio3, X.mio2 Plus and X.mio2 Systems

This section details the available DVE inputs that can be used simultaneously on systems with the [Matrox X.mio3](#), X.mio2 Plus or X,mio2 video boards.

X.mio2 video board exclusively: Installation of the [Matrox X.RIO](#) expansion module provides the Matrox X.mio2 video card with four more inputs, allowing for up to 8 video inputs on the X.mio2.

The values detailed in the following tables should be considered as reference, as the actual performance can differ slightly depending on the performance of the system in use.

This section contains the following topics:

- [PAL/NTSC](#)
- [720p50](#)
- [720p60M](#)
- [1080i50](#)
- [1080i60M](#)

12.4.1 PAL/NTSC

Scaling [%]	Foreground /Background	X.mio3SDI-Inputs	X.mio2 PlusSDI-Inputs	X.mio2 with X. RIOSDI-Input
100	On	8	8	8
	Off	8	8	8
99	On	8	8	8
	Off	8	8	8
50	On	8	8	8
	Off	8	8	8

12.4.2 720p50

Scaling [%]	Foreground /Background	X.mio 3SDI-Inputs	X.mio2 Plus SDI-Inputs	X.mio2 with X. RIOSDI-Inputs
100	On	8	4	4

Scaling [%]	Foreground /Background	X.mio 3SDI-Inputs	X.mio2 Plus SDI-Inputs	X.mio2 with X. RIOSDI-Inputs
	Off	8	5	5
99	On	8	3	3
	Off	8	4	4
50	On	8	6	6
	Off	8	6	6

12.4.3 720p60M

Scaling [%]	Foreground /Background	X.mio3SDI-Inputs	X.mio2 PlusSDI-Inputs	X.mio2 with X. RIOSDI-Inputs
100	On	8	3	3
	Off	8	4	4
99	On	8	2	2
	Off	8	3	3
50	On	8	5	5
	Off	8	5	5

12.4.4 1080i50

Scaling [%]	Foreground /Background	X.mio3SDI-Inputs	X.mio2 PlusSDI-Inputs	X.mio2 with X. RIOSDI-Inputs
100	On	8	4	4
	Off	8	5	5
99	On	8	3	3
	Off	8	4	4
50	On	8	5	5
	Off	8	5	5

12.4.5 1080i60M

Scaling [%]	Foreground /Background	X.mio3SDI-Inputs	X.mio2 PlusSDI-Inputs	X.mio2 with X. RIOSDI-Inputs
100	On	7	3	3

Scaling [%]	Foreground /Background	X.mio3SDI-Inputs	X.mio2 PlusSDI-Inputs	X.mio2 with X.RIOSDI-Inputs
	Off	8	4	4
99	On	7	2	2
	Off	8	2	2
50	On	8	2	2
	Off	8	2	2

Note: For setups using the Matrox X.mio2 without the X.RIO expansion module, 4 is the maximum number of inputs. Consequently, for resolution and scaling combinations where the maximum supported inputs are *less* than 4, the X.RIO module is not required.

12.5 Audio Cable Assignment

This section contains information on the following topics:

- [AES Input Cable Assignment](#)
- [AES Output Cable Assignment](#)
- [Embedded Input](#)
- [Embedded Output](#)

12.5.1 AES Input Cable Assignment

Card	Viz Audio Config	AES Cable	Matrox Video Channel
X.mio3	2 tracks	A IN 1/2	Video IN A
		A IN 3/4	Video IN B
		A IN 5/6	Video IN C
		A IN 7/8	Video IN D
		B IN 1/2	Video IN E
		B IN 3/4	Video IN F
		B IN 5/6	Video IN G
		B IN 5/6	Video IN H
	4 tracks	A IN 1/2+3/4	Video IN A
		A IN 5/6+7/8	Video IN B

Card	Viz Audio Config	AES Cable	Matrox Video Channel
		B IN 1/2+3/4	Video IN C
		B IN 5/6+7/8	Video IN D
	8 tracks	A IN 1/2+3/4+5/6+7/8	Video IN A
		B IN 1/2+3/4+5/6+7/8	Video IN B
	16 tracks	A IN 1/2+3/4+5/6+7/8	Video IN A
		B IN 1/2+3/4+5/6+7/8	
X.mio2, X.mio2 Plus	2 tracks	A IN 1/2	Video IN A
		A IN 3/4	Video IN B
		A IN 5/6	Video IN C
		A IN 7/8	Video IN D
	4 tracks	A IN 1/2+3/4	Video IN A
		A IN 5/6+7/8	Video IN B
		B IN 1/2+3/4	Video IN C
		B IN 5/6+7/8	Video IN D
	8 tracks	A IN 1/2+3/4+5/6+7/8	Video IN A or Video IN C
		B IN 1/2+3/4+5/6+7/8	Video IN B or Video IN D
	16 tracks	A IN 1/2+3/4+5/6+7/8	Video IN A, or
		B IN 1/2+3/4+5/6+7/8	Video IN B, or
			Video IN C, or
			Video IN D
X.mio	2 tracks	A IN 1	Video IN A
		B IN 1	Video IN B
	4 tracks	A IN 1+2	Video IN A
		B IN 1+2	Video IN B
	8 tracks	A IN 1+2	Video IN A
		B IN 1+2	
	16 tracks	Not supported	

12.5.2 AES Output Cable Assignment

Card	Viz Audio Config	AES Cable	Matrox Video Channel	
X.mio3	2 tracks	A Out 1/2	Video Out A	
		A Out 3/4	Video Out B	
		A Out 5/6	Video Out C	
		A Out 7/8	Video Out D	
		B Out 1/2	Video Out E	
		B Out 3/4	Video Out F	
		B Out 5/6	Video Out G	
		B Out 7/8	Video Out H	
4 tracks	4 tracks	A Out 1/2+3/4	Video Out A	
		A Out 5/6+7/8	Video Out B	
		B Out 1/2+3/4	Video Out C	
		B Out 5/6+7/8	Video Out D	
8 tracks	8 tracks	A Out 1/2+3/4+5/6+7/8	Video Out A	
		B Out 1/2+3/4+5/6+7/8	Video Out B	
16 tracks	16 tracks	A Out 1/2+3/4+5/6+7/8	Video Out A	
		B Out 1/2+3/4+5/6+7/8		
X.mio2, X.mio2 Plus	2 tracks	A OUT 1/2	Video Out 0	
		B OUT 1/2	Video Out 1	
	4 tracks	4 tracks	A OUT 1/2+3/4	Video Out 0
			B OUT 1/2+3/4	Video Out 1
	8 tracks	8 tracks	A OUT 1/2+3/4+5/6+7/8	Video Out 0
			B OUT 1/2+3/4+5/6+7/8	Video Out 1
	16 tracks	16 tracks	A OUT 1/2+3/4+5/6+7/8+9/10+11/12+13/+14+15/16	Video Out 0
			B OUT 1/2+3/4+5/6+7/8+9/10+11/12+13/+14+15/16	Video Out 1

Card	Viz Audio Config	AES Cable	Matrox Video Channel
X.mio	2 tracks	A OUT 1	Video Out 0
		A OUT 3	Video Out 1
	4 tracks	A OUT 1+2	Video Out 0
		A OUT 3+4	Video Out 1
	8 tracks	A OUT 1+2	Video Out 0
		B OUT 1+2	Video Out 1
		A OUT 3+4	
	16 tracks	A OUT 1+2+3+4	Video Out 0
		B OUT 1+2+3+4	

12.5.3 Embedded Input

Card/Viz Audio Config	2 tracks	4 tracks	8 tracks	16 tracks
X.mio3	yes	yes	yes	yes
X.mio2 Plus	yes	yes	yes	yes
X.mio2	yes	yes	yes	yes
X.mio	yes	yes	yes	yes

12.5.4 Embedded Output

Card/Viz Audio Config	2 tracks	4 tracks	8 tracks	16 tracks
X.mio3	yes	yes	yes	yes
X.mio2 Plus	yes	yes	yes	yes
X.mio2	yes	yes	yes	yes
X.mio	yes	yes	yes	yes

12.6 Matrox DSX LE Series

Viz Engine supports the Matrox DSX LE series, versions 2, 3 and 4. The DSX LE series cards were initially introduced as an entry level video card, for installations where no compositor is required. It has since been expanded with some card models that also feature a compositor less feature-rich and advanced than those found on the X.mio series cards.

The main features of the DSX LE series video boards are:

- The DSX LE4 is a passively cooled video card featuring HD-BNC connectors and video clip playback capabilities
- The DSX LE3/**/100 does not have video clip playback capabilities. To play video clips (SD and HD) as Texture, upgrade from 100 to 500, or 550 to include support for Apple ProRes.
- The standard Matrox DSX LE3 does not provide DVE capabilities or other high-end features, such as frame synchronizers on the input or advanced failsafe capabilities.

On Boards with no on-board compositor, the software compositor is activated by default. The output of the fill signal differs between the software compositor and the hardware compositor. Although the results are the same when looking at them after a keyer, to get the desired result, set the flag `use_compositor` in the configuration file to 0 .

This section describes the following information:

- [Cables and Connectors](#)
- [Breakout Cables and Connectors](#)
- [Video Cable Assignment](#)
- [Audio Cable Assignment](#)

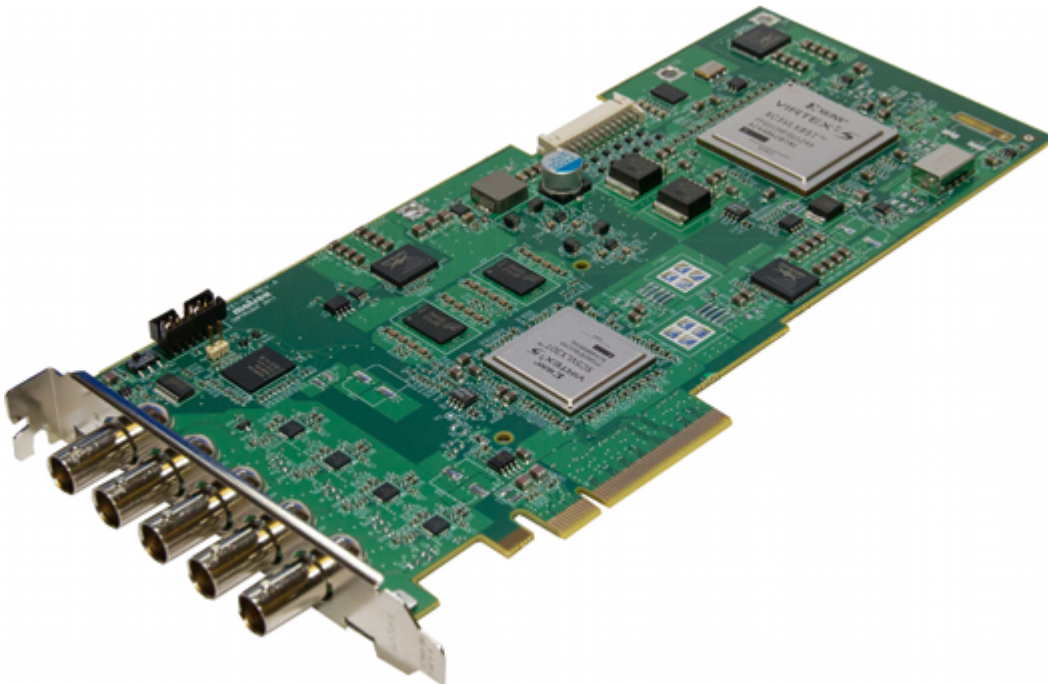

12.6.1 Cables and Connectors

The connectors for DSX LE3 are:

- PCIe board compliant to PCIe 2.0 in x8 or x16 slot
- x4 SDI video outputs in SD and HD
- x16 Embedded Audio I/O Channels per SDI Stream

The board comes with an additional card and break-out cables for AES audio. Fill and key signals as well as reference signals, or Genlock, have their own BNC connectors. The board should be installed in the same slot as the X.mio2/2 Plus board, and uses the same driver versions as Matrox X.mio2/2 Plus.

The connectors for DSX LE2/CG are:

- PCIe board compliant to PCIe 2.0 in x8 or x16 slot
- x2 SDI video outputs in SD and HD
- x16 Embedded Audio I/O Channels per SDI Stream

12.6.2 Breakout Cables and Connectors

Both the DSX LE3 and DSX LE2/CG come with a set of breakout cables, and thus do not require any breakout box. However, the DSX LE2/CG requires the included power cables to be connected, or else the board will not work.

The breakout cable is used for the reference signal, or Genlock, and AES output. Fill and key signals have their own BNC connectors. Both boards should be installed in the same slot as the X.mio2/2Plus board. The DSX-series video cards only support embedded audio, and do not support audio-extension cards for AES input.

12.6.3 Video Cable Assignment

Matrox DSX LE4, LE3 and DSX LE2/CG all have HD capabilities. The DSX.LE3 has 4 video output connectors, whereas the DSX.LE2/CG has 2 video output connectors. None of them have video input capabilities. The boards are used for outputting fill and key signals, and are useful in systems that do not need live video input or codec support.

The 4 video output connectors for the DSX.LE3 will give you two pairs of fill and key, where output A and B are Fill and output C and D are Key, respectively.

The 2 video output connectors for the DSX.LE2/CG 2 will give you one pair of fill and key, where output A is Fill and output B is Key.

12.6.4 Audio Cable Assignment

This section contains information on the following topics:

- [AES Input Cable Assignment](#)
- [AES Output Cable Assignment](#)
- [Embedded Input](#)
- [Embedded Output](#)

AES Input Cable Assignment

Card	Viz Audio Config	AES Cable	Matrox Video Channel
DSX.LE3	2 tracks	Not supported	
DSX.LE2/CG	4 tracks	Not supported	
	8 tracks	Not supported	
	16 tracks	Not supported	

AES Output Cable Assignment

Card	Viz Audio Config	AES Cable	Matrox Video Channel
DSX.LE3	2 tracks	AES OUT 1/2	Video Out 0
	4 tracks	AES OUT 1/2+3/4	Video Out 0
	8 tracks	AES OUT 1/2+3/4+5 /6+7/8	Video Out 0
	16 tracks	Not supported	
DSX.LE2/CG	2 tracks	AES OUT 1/2	Video Out 0
	4 tracks	AES OUT 1/2+3/4	Video Out 0
	8 tracks	Not supported	
	16 tracks	Not supported	

Embedded Input

Card/Viz Audio Config	2 tracks	4 tracks	8 tracks	16 tracks
DSX.LE3	-	-	-	-
DSX.LE2/CG	-	-	-	-

Embedded Output

Card/Viz Audio Config	2 tracks	4 tracks	8 tracks	16 tracks
DSX.LE3	yes	yes	yes	yes
DSX.LE2/CG	yes	yes	yes	no

12.7 Matrox X.RIO

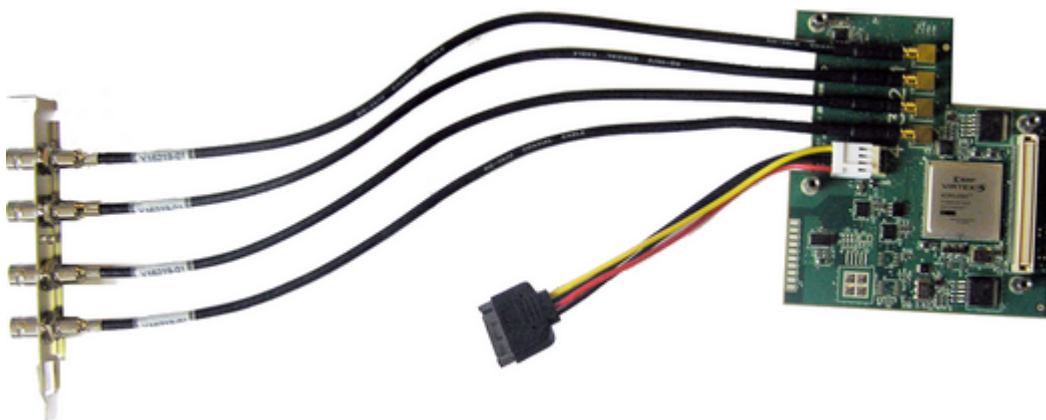

Matrox X.RIO is an expansion module for the Matrox X.mio2 board that provides four configurable I/Os.

With the Matrox X.mio2 and X.RIO combined, Viz Engine supports up to 8 video inputs. The use of 8 inputs will require an upgrade of the X.mio2, which in most cases ships with 2 inputs and 4 outputs. Support for the Matrox X.RIO expansion module started with Viz Engine 3.5.

This section contains information on the following topics:

- [Cables and Connectors](#)
 - [Breakout Cables and Connectors](#)
 - [Video Cable Assignment](#)
 - [Audio Cable Assignment](#)
- [Install and Configure the Matrox X.RIO](#)

12.7.1 Cables and Connectors

As the X.RIO module expands the capabilities of the Matrox X.mio2-based systems providing four extra inputs you will be able to have 4 key and 4 fill inputs and 2 key and 2 fill outputs. Note that the extra connectors can only be used as 4 extra inputs (not outputs).

With an HP Z800 machine, Matrox X.mio2 and X.RIO, the following is possible: with SD, eight inputs are working as DVE or Texture, whereas with HD, six inputs are working as DVE (at approximately 65%) or Texture.

.....
Note: The actual number of working inputs depend on the bandwidth of the system, resource usage, how many clips are played at the same time, and if they are played as DVE or Texture.
.....

Breakout Cables and Connectors

All breakout cable assignments are handled by the X.mio2 board and its breakout box, see the Matrox X.mio Series section.

Video Cable Assignment

All video cable assignments are handled by the X.mio2 board, see the Matrox X.mio Series section.

Audio Cable Assignment

All audio cable assignments are handled by the X.mio2 board, see the Audio Cable Assignment.

12.7.2 Install and Configure the Matrox X.RIO

This section contains information on the following procedures:

- [To Install the Matrox X.RIO Expansion Module](#)
- [To Configure the Matrox X.RIO Board](#)

To Install the Matrox X.RIO Expansion Module

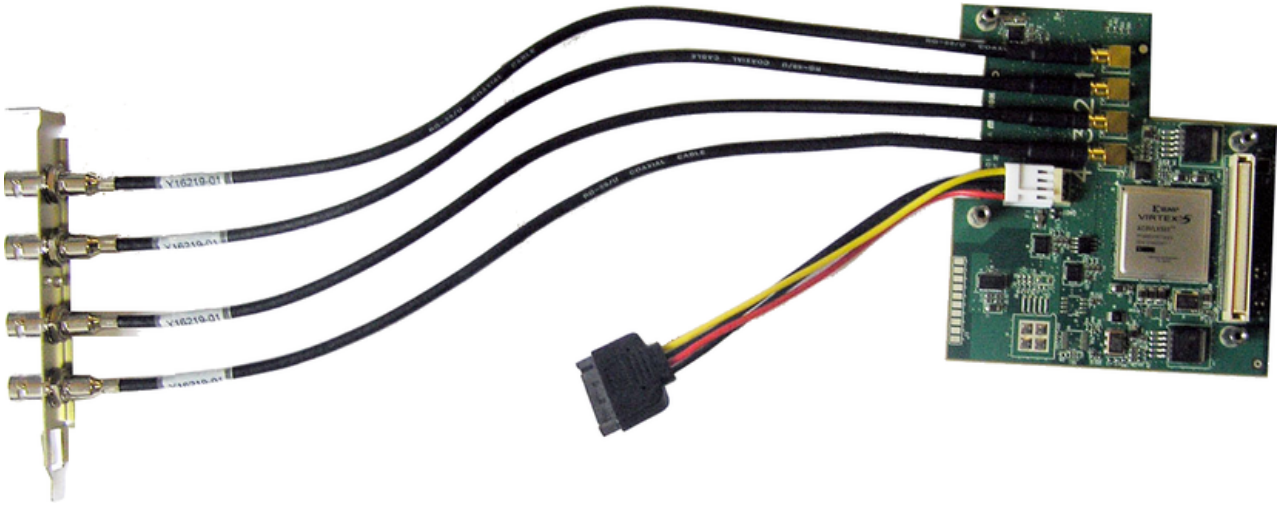

1. Connect the power cable to the X.RIO.
2. The slot panel has numbers from 1-4. Make sure to connect them carefully, as the mini-BNCs can break easily.

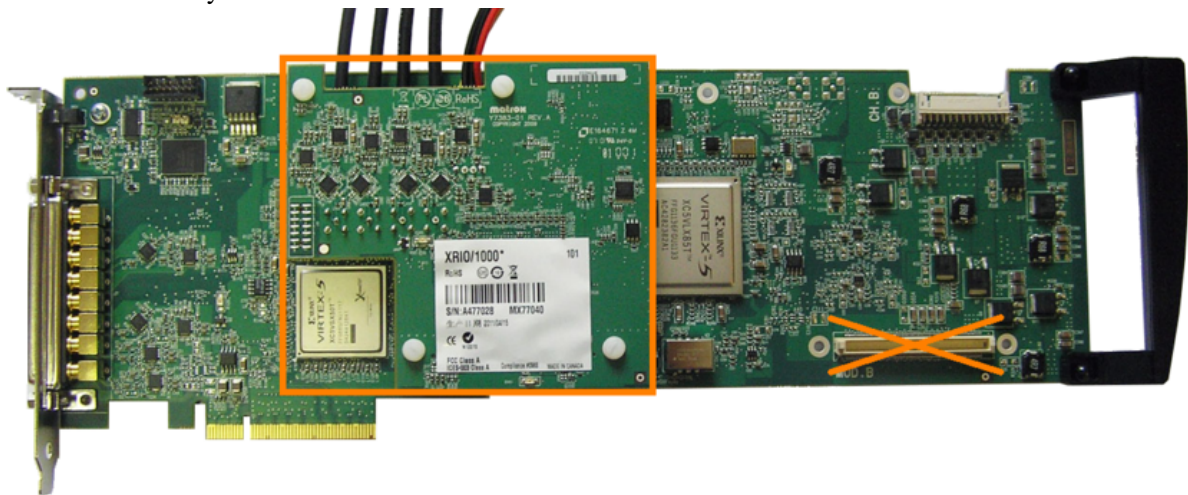

3. Mount the X.RIO on the X.mio2 board “Mod A” connector. The Mod B connector will not work.
4. Use the screws to fix the X.RIO expansion module.

.....
Tip: When installing an X.mio2 with X.RIO into a HP Z800, make sure that the mini-BNCs do not get disconnected during installation, as they are very hard to connect while the X.RIO board is mounted on the X.mio2.
.....

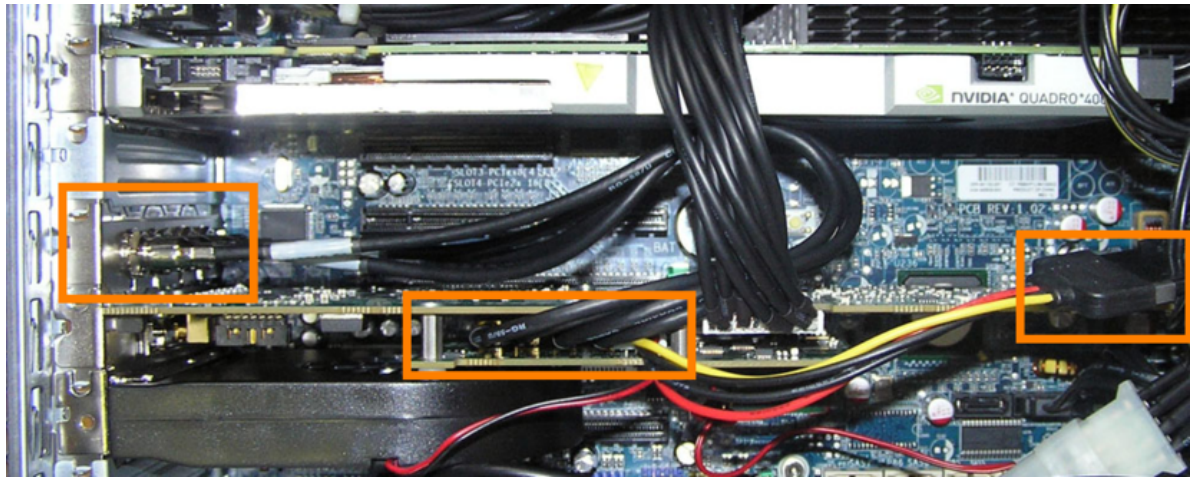

5. Mount the slot panel with the 4 additional inputs in any free slot and connect the power for the X.RIO. Also, make sure the cables is not in touch with any fans.

To Configure the Matrox X.RIO Board

1. Install the Matrox driver.
2. Start Matrox X.Info.
3. Under the X.mio2 /24 Card tab select the Hardware option, to enable the X.RIO Configure button.
4. In the X.RIO Module Configuration dialog-box check that the configuration for next restart is set to 4 Inputs 0 Outputs.
5. Restart the computer.
6. Start Viz Configuration, and go to the Matrox section. From the drop-down menu, the VideoIn parameters, for example **E**, **F**, **G** and **H**, can be configured. Note that the X.RIO inputs are mapped to Viz Engine's channels 5-8 by default. This means that when an X.mio2/24 is in use, Viz Engine's channels 3 and 4 are not in use.

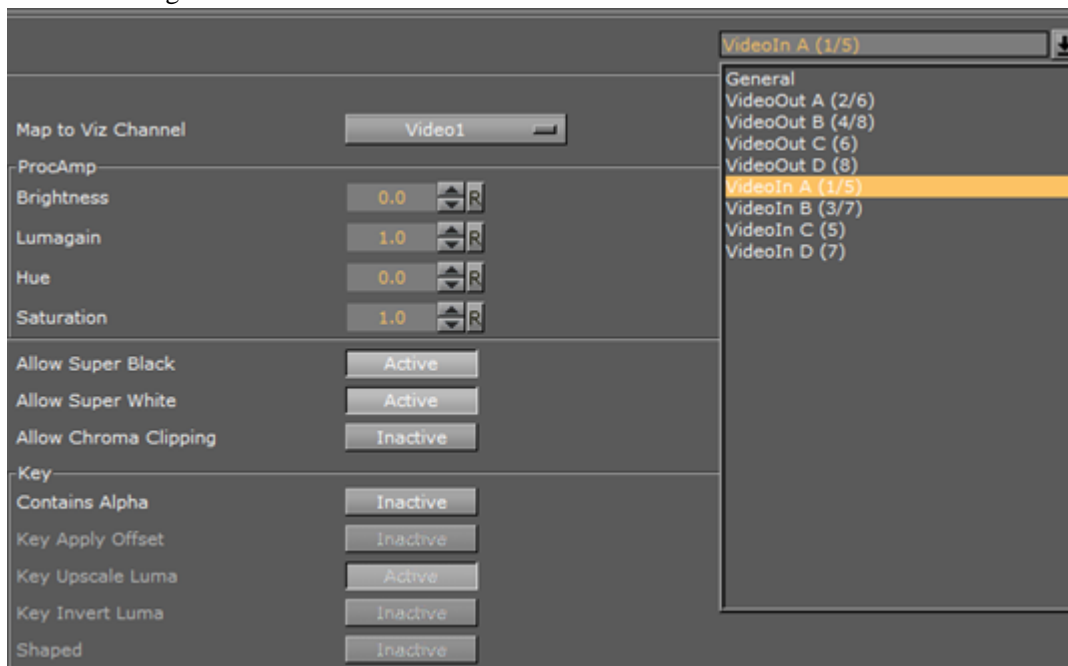

12.8 Matrox X.Open



Matrox X.Open is a USB dongle with no video outputs or inputs that you will find on a regular video board such as the Matrox X.mio Series, but it has support for all the same codecs as a typical Matrox board. It is therefore well suited for video clip playback using the Matrox clip player for IP, DVI as well as VGA output.

12.9 Matrox Driver Installation

The first time a machine is started with a Matrox board or dongle installed, the operating system will prompt the user to install the necessary Matrox drivers. Before installing a new driver, or upgrading the existing drivers, any currently installed drivers must be removed first. Please refer to the section To Remove the Matrox Driver for further information on how to remove any such drivers.

- However, please pay attention to the following considerations:
- A new driver should not be installed before the new hardware is installed.
- The use of a different driver version than that which was shipped with the video board is not recommended.
- A driver version, which is not recommended, will in most cases cause the system to be unresponsive.
- Use the supplied driver installer application, and do not rely on drivers automatically installed by the operating system.
- Please refer to the Drivers and Configuration History section for information on which driver version is recommended for the Matrox video card and Viz Engine version in use.

As there are many driver versions available, it is important to compare the versions reported by the Matrox X.info utility to check that the driver and firmware versions match. A warning will be displayed if the versions do not match.

This section contains information on the following topics:

- [To Install the Matrox Driver](#)
- [To Remove the Matrox Driver](#)
- [To Upgrade the Matrox Driver](#)
- [To Check the Installation](#)
- [To Check the Installation with Windows Device Manager](#)

12.9.1 To Install the Matrox Driver

1. Locate the latest Matrox driver (DSX.utils): <ftp://ftp.vizrt.com/products/Vizrt%20Drivers/Matrox/Xmio/<driver>/>
2. Download and save the installation file to the local hard drive.

3. Open the downloaded DSX.utils.exe file. This file automatically extracts the installation files and launches the installation wizard.

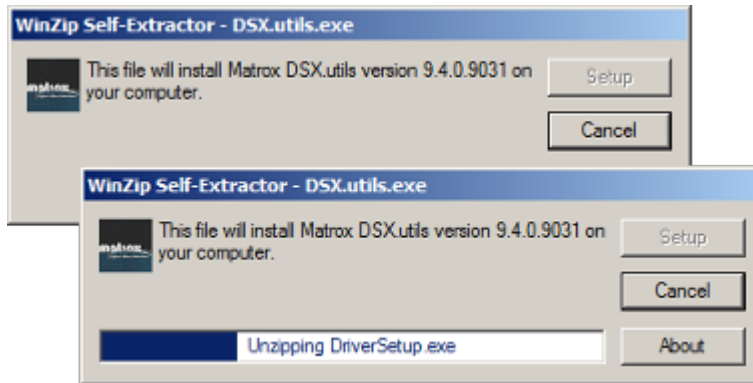

4. Follow the on screen instructions.

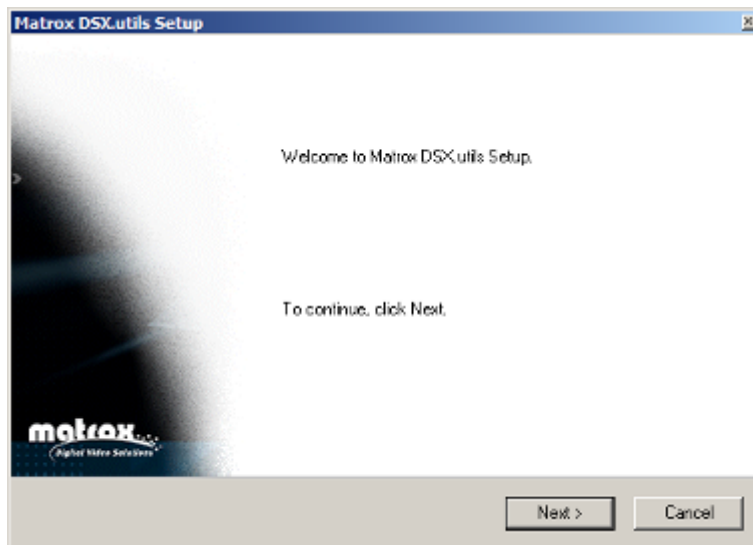

5. In case the Windows Security window pops up, tick the Always trust software from Matrox Electronic Systems check-box. This allows for a faster installation procedure in any subsequent driver installations. If left un-checked, each required driver will need explicit permission to be installed.

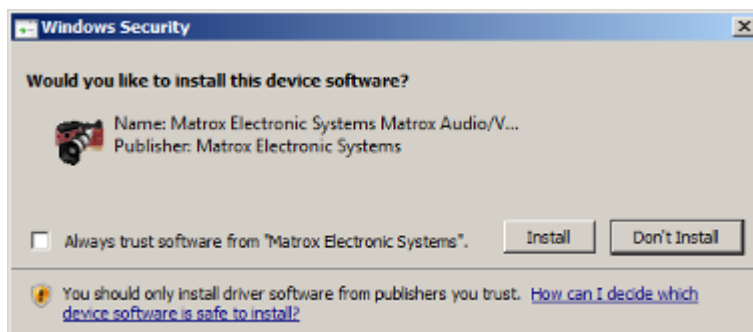

6. Click Install to start the installation. The installation can take several minutes.
7. When completed, a pop-up window will confirm the successful installation. Click OK.

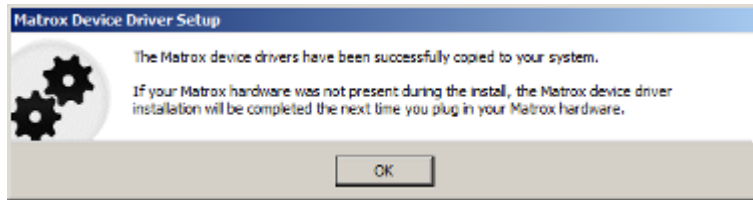

8. After the driver has been installed, an icon (1) will appear in the system tray.



.....
Note: The firmware upgrade now starts. This can take a few minutes to complete.
.....

12.9.2 To Remove the Matrox Driver

1. Go to *Start -> Control Panel -> Programs and Features*.
2. Locate the Matrox DSX.utils <version>.
3. Click the Uninstall button, or right click the entry and select Uninstall from the context menu.
4. Follow the on screen instructions.

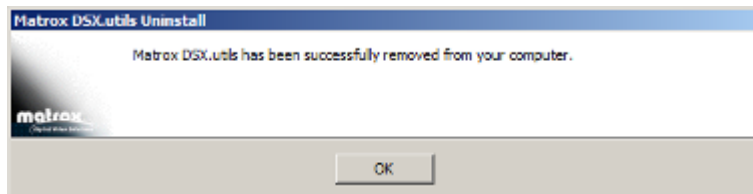

5. Reboot the system.

.....
Tip: In some cases, the Matrox driver removal process will automatically reboot the system.
.....

12.9.3 To Upgrade the Matrox Driver

1. Remove old DSX.utils (see To Remove the Matrox Driver)
2. Reboot system.
3. Install new DSX.utils (see To Install the Matrox Driver).

12.9.4 To Check the Installation

1. Click the Matrox system tray icon.
2. Select Open X.info.



3. In the Display Information About drop-down, select System.

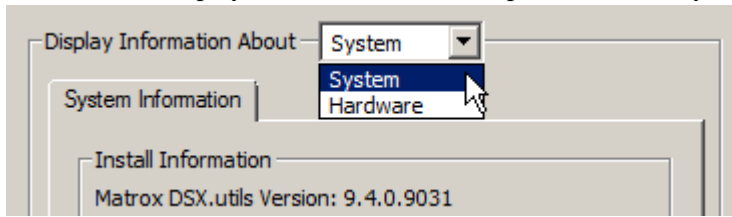

4. Check that the correct driver version was installed.

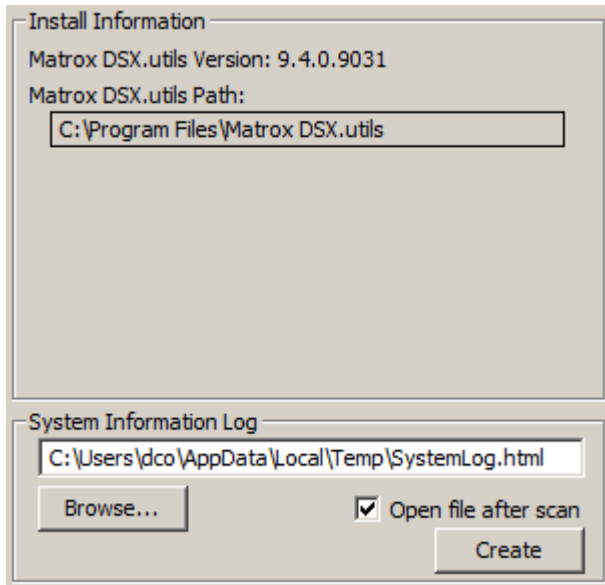

5. In the **Display Information About** drop-down, select **Hardware** and click on the installed card tab, for example **LE3/22C**.

.....
Note: The information shown in the panel can look different depending on the installed Matrox card.
.....

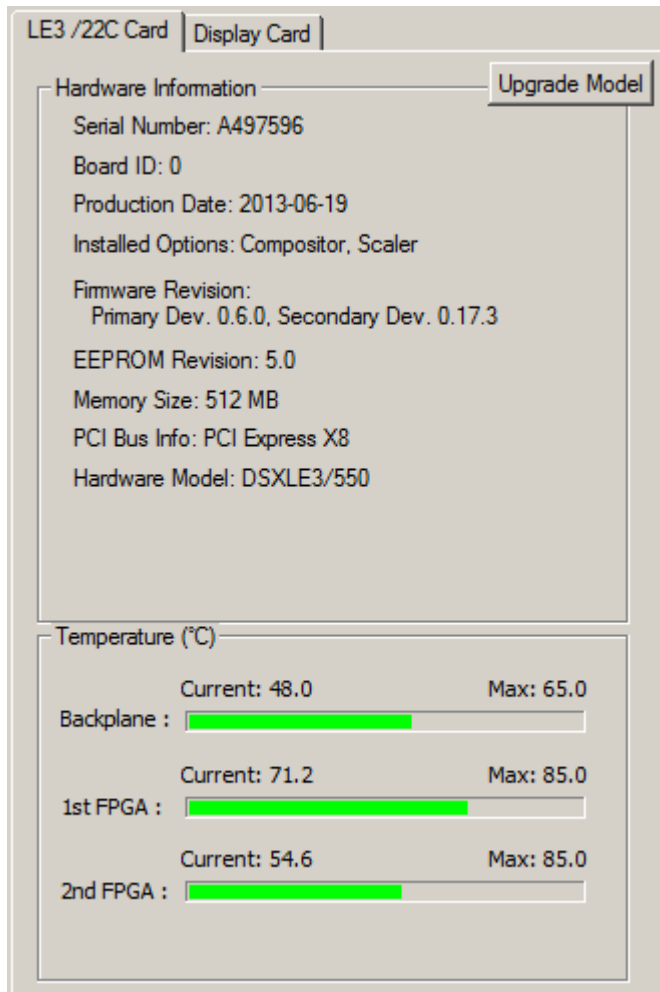

6. Check the these details:

- Under Hardware Information, check the Installed Options for Compositor, to confirm that the board is taking advantage of the on-board compositor. Some boards do not have an on-board compositor. The Matrox X.mio2 Plus does have an on-board compositor, even though this is not listed.
- See PCI Bus Info and check that the board was put into a PCIe slot operating at the right frequency.
- See Hardware Model, for example, X.mio2 Plus 8500, to check for Mixed Mode Video Support.

12.9.5 To Check the Installation with Windows Device Manager

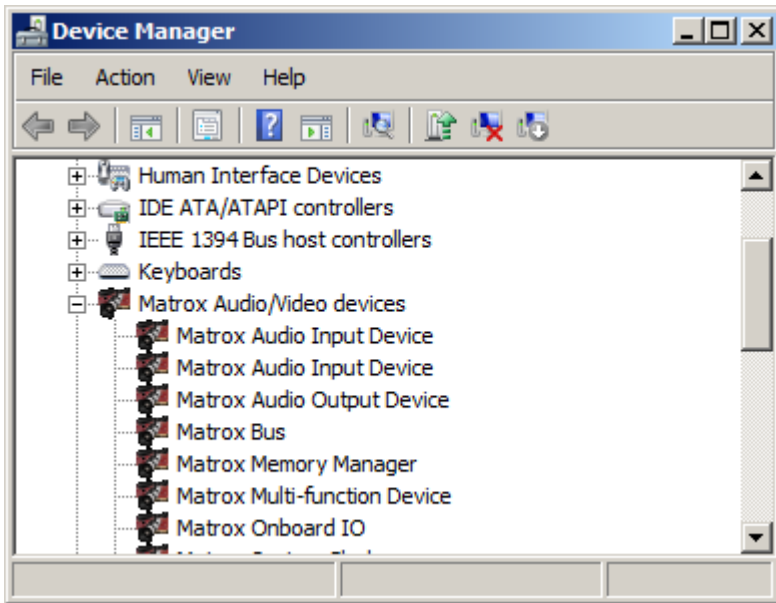

1. Start the **Device Manager**, by either:
 - Click **Start**, then **Run**, and type `devmgmt . msc`, or
 - Right-click **My Computer**, select **Manage** and then **Device Manager**, or
 - Right-click **My Computer**, select **Properties** and click the **Hardware** tab, then click **Device Manager**, or
 - Run the command `start devmgmt . msc` from the **Command Prompt**
2. Expand the **Matrox Audio/Video devices** node to see the devices that are installed.

12.10 Mixed Mode Video Support

This section gives an overview of the Matrox' mixed mode video support. The tables are valid for both genlock families in Viz Engine. One is 25/50 (e.g. PAL/720p50/1080i25/1080i50) and the other is 30M/60M (e.g. NTSC/720p60M/1080i30M/1080i60M).

The genlock family refers to the used house signal (e.g. black burst) frequency - typically PAL for the first and NTSC for the latter. Please observe that genlock families can not be mixed.

The following contain information on the following topics:

- **Source: PAL or NTSC**
 - [Video In to DVE and Texture](#)
 - [Clip In to DVE and Texture](#)
- **Source: 720p**
 - [Video In to DVE and Texture](#)
 - [Clip In to DVE and Texture](#)
- **Source: 1080i**
 - [Video In to DVE and Texture](#)
 - [Clip In to DVE and Texture](#)

12.10.1 Source: PAL or NTSC

The first two tables show video in to DVE and texture output capabilities, while the next two tables show clip in to DVE and texture output capabilities. Please observe that genlock families can not be mixed.

Video In to DVE and Texture

Output DVE	Video In		
	PAL/NTSC	720p	1080i
PAL/NTSC	OK	-	-
720p	-	-	-
1080i	OK	-	-

Output Texture	Video In		
	PAL/NTSC	720p	1080i
PAL/NTSC	OK	-	-
720p	OK	-	-
1080i	OK	-	-

Clip In to DVE and Texture

Output DVE	Clip In		
	PAL/NTSC	720p	1080i
PAL/NTSC	OK	-	-
720p	-	OK	-
1080i	OK	OK	-

Output Texture	Clip In		
	PAL/NTSC	720p	1080i
PAL/NTSC	OK	-	-
720p	OK	OK	-
1080i	OK	OK	OK

12.10.2 Source: 720p

The first two tables show video in to DVE and texture output capabilities, while the next two tables show clip in to DVE and texture output capabilities. Please observe that genlock families can not be mixed.

Video In to DVE and Texture

Output DVE	Video In		
	PAL/NTSC	720p	1080i
PAL/NTSC	-	-	-
720p	-	-	OK
1080i	-	-	OK

Output Texture	Video In		
	PAL/NTSC	720p	1080i
PAL/NTSC	-	OK	-
720p	-	OK	-
1080i	-	OK	-

Clip In to DVE and Texture

Output DVE	Clip In		
	PAL/NTSC	720p	1080i
PAL/NTSC	OK	-	-
720p	-	OK	-
1080i	OK	OK	OK

Output Texture	Clip In		
	PAL/NTSC	720p	1080i
PAL/NTSC	OK	OK	-
720p	OK	OK	-
1080i	OK	OK	OK

12.10.3 Source: 1080i

The first two tables show video in to DVE and texture output capabilities, while the next two tables show the clip in to DVE and texture output capabilities. Please observe that genlock families can not be mixed.

Video In to DVE and Texture

Output DVE	Video In		
	PAL/NTSC	720p	1080i
PAL/NTSC	-	-	-

Output DVE	Video In		
720p	-	-	-
1080i	-	-	OK

Output Texture	Video In		
	PAL/NTSC	720p	1080i
PAL/NTSC	-	-	OK
720p	-	-	OK
1080i	-	-	OK

Clip In to DVE and Texture

Output DVE	Clip In		
	PAL/NTSC	720p	1080i
PAL/NTSC	OK	-	-
720p	-	OK	-
1080i	OK	OK	OK

Output Texture	Clip In		
	PAL/NTSC	720p	1080i
PAL/NTSC	OK	-	OK
720p	OK	OK	OK
1080i	OK	OK	OK

12.11 Supported Codecs

The Matrox X.mio, X.mio2, X.mio2 Plus and X.mio3 video cards all support a selection of different codecs for both SD and HD. Depending on the class, a license upgrade may be required to extend the range of codecs supported by the installed video card. The Matrox video cards have a built-in license dongle used by the Matrox codecs to determine licensing rights. Certain codecs require certain card classes.

For the Matrox X.mio, X.mio2 and X.mio2 Plus video cards, the following classes apply:

- 6000 class: SD codecs only. No D10
- 8000 class: SD, HD, D10 and D12 codecs
- 8500 class: SD, HD, D10 and D12 codecs, and Apple ProRes playback capabilities

For the Matrox X.mio3 and DSX LE 4 video cards, the following classes apply:

- Class 100: No clip playback
- Class 500: SD and HD clip playback

- Class 550: SD and HD clip playback, including support for Apple ProRes codecs
See Supported Codecs in the Viz Artist User Guide for a complete list of all supported codecs and formats.

.....
IMPORTANT! The Codec DNxHD requires its own license, issued by Vizrt.
.....

All codecs are implemented in the software.

12.12 Watchdog

A watchdog is essentially a timer that allows a system to continue video pass-through when an application has crashed or there is a system failure. The X.mio has a built-in watchdog capability; however, the bypass only works for video (including optional embedded audio), while AES audio is not bypassed.

The watchdog can be used as a Mechanical Bypass (copper-to-copper) or a Hardware Bypass (default).

This section contains the following topics and procedures:

- [Mechanical Bypass](#)
- [Hardware Bypass](#)
- [Transition from Watchdog to Video](#)
- [To Enable Mechanical Bypass](#)

12.12.1 Mechanical Bypass

A relay (input to output) that works in case of a power loss. To use mechanical bypass see [To Enable Mechanical Bypass](#).

12.12.2 Hardware Bypass

Operates in a powered machine state (input to the board's output). In hardware bypass mode the incoming video and reference signals must be compliant to provide the correct watchdog functionality.

.....
Tip: The hardware bypass introduces an h-phase on the output. The value of this phase depends on the video output format.
.....

12.12.3 Transition from Watchdog to Video

When watchdog is deactivated (with `video_loopthrough_mode=2`) and a scene with DVE input is loaded, a few black frames are shown. The watchdog should be activated after the input channel is ready. To provide a glitch free transition from watchdog to video configure the watchdog's deactivation delay by setting the delay in fields for the watchdog to wait before deactivation.

12.12.4 To Enable Mechanical Bypass

1. Stop Viz Engine.
2. Open the Viz Config file (for example: `VIZ-<hostname>-0-0.cfg`).
3. Locate `SECTION MATROX_CONFIG`.

4. Enable the Matrox watchdog setting:

```
Matrox0.WatchDogUseHardwareBypass = 0
```

5. Save the file.
6. Start Viz Engine.

12.13 Configuration History for Matrox X.mio and DSX Series

Viz Artist/Engine Version	Driver	Supported Hardware
3.9.0	DSX.utils 9.8.0.22358	X.mio3 IP, X.mio3, X.mio2 Plus, X.mio2, DSX LE4, DSX LE3, DSX LE2/CG
3.8.3	DSX.utils 9.7.0.21682	X.mio3 IP, X.mio3, X.mio2 Plus, X.mio2, DSX LE4, DSX LE3, DSX LE2/CG
3.8.2	DSX.utils 9.6.0.18841	X.mio3, X.mio2 Plus, X.mio2, DSX LE4, DSX LE3, DSX LE2/CG
3.8.1	DSX.utils 9.6.0.18836	X.mio3, X.mio2 Plus, X.mio2, DSX LE3, DSX LE2/CG
3.8.0	DSX.utils 9.5.0.17766	X.mio3, X.mio2 Plus, X.mio2, DSX LE3, DSX LE2/CG
3.7.0	DSX.utils 9.4.0.9040 (release)	X.mio2 Plus, X.mio2, X.mio, DSX LE3, DSX LE2/CG
3.6.4	DSX.utils 9.2.2.2343	X.mio2 Plus, X.mio2, X.mio, DSX LE3, DSX LE2/CG
3.6.3	DSX.utils 9.2.2.2335 (SP2)	X.mio2 Plus, X.mio2, X.mio, DSX LE3, DSX LE2/CG
3.6.2	DSX.utils 9.2.2.2331 (SP2)	X.mio2 Plus, X.mio2, X.mio, DSX LE3, DSX LE2/CG
3.6.0	DSX.utils 9.2.2.2317 (SP2)	X.mio2 Plus, X.mio2, X.mio, DSX LE3, DSX LE2/CG
3.5.3 (see note below)	DSX.utils 7.5.2.1448	X.mio2, X.mio, DSX LE2/CG
3.5.0 - 3.5.2	DSX.utils 7.5.2.447 (SP2)	X.mio2, X.mio, DSX LE2/CG
3.3.x	DSX.utils 7.5.2.443	X.mio2, X.mio
3.2.2	DSX.utils 5.0.3.171	X.mio2, X.mio
3.1.0 - 3.2.1	DSX.utils 5.0.3.166	X.mio2, X.mio

12.13.1 Configuration History for Matrox X.Open

The Matrox X.Open use the same driver as the Matrox X.mio series boards.

12.14 Troubleshooting Matrox Video Hardware

It might be necessary to reset the X.mio2 Plus board. This needs to be done for example when Viz Engine reports:

- "0xefac9019: Generic driver error: The requested operation was unsuccessful" at startup.
- "0xeddd8008: Topology driver error: Watchdog specified already in use by another application." at startup.
- "VideoClipInOut_Xmio2Plus::SequenceVideoOut SequenceVideoOut no output node." during operation.

For this a reset mechanism has been implemented for the Viz Engine. To activate this mechanism, do this procedure:

1. Stop all Viz Engines (in dual channel setups both Viz Engines must be stopped).
2. Open the Viz Configuration file.
3. Set `Matrox0.ResetTopology = 1`.
4. Start up the respective Viz Engines.

.....
Note: The `Matrox0.ResetTopology` setting will be automatically set back to 0 after the reset has been performed
.....

The reset feature also clears the on-board memory of the X.mio2 Plus board. This operation removes all Matrox X.RIOs and their topologies from the on-board memory.

After the reset everything will be restored automatically according to the configuration settings. This also applies to both Viz Engines in a Dual Channel setup.

12.14.1 Replacing a Video Board

This procedure describes how to safely replace a video board on a system with an existing video board, or a system that previously has had a video board installed.

1. Remove the video board drivers.
2. Shut down the machine.
3. If present, remove the currently installed video board.
4. Install the replacement video board.
5. Install the video board drivers.

.....
IMPORTANT! When changing a Matrox video board the `Matrox.Devices` setting, set in the Viz Config file's `SECTION MATROX_CONFIG`, will not be updated. The Matrox support will not be correct and the new board will not work. In this case the setting must be removed and Viz Engine restarted such that Viz Engine can insert the new serial number.
.....

12.15 General Information

The number of DVE channels that can be used in Viz Engine depends on the video hardware. The limiting factor is the amount of memory on the card, but also the available bandwidth for transfers between the FPGA and the on-board memory. For example, on a [Matrox X.mio3](#) card, you can scale 8 1080i surfaces to 99.9% and compose those 8 surfaces at the same time. If the scaling factor is reduced, the overall DVE performance will increase, due to the lowered amount of bandwidth needed. At a certain point, it might even be possible to add an additional DVE input.

Looking at a single channel system fit with an X.mio3, 9 inputs can be used as DVE, as one is always consumed by the background layer. However, setting the system up as dual channel, reduces the amount of DVE layers to 3 in each channel, considering that 2 background layers are used.

12.15.1 Single Channel performance (1080i50):

The maximum number of DVE Assets (excluding Fore- and Background layer) on **xMio2+** :

Size	Maximum
100%	6
99%	6
33%	6

The maximum number of DVE Assets (excluding Fore- and Background layer) on **xMio3** :

Size	Maximum
100%	9
99%	9
33%	10 (Break even point ~95%)

12.15.2 Dual Channel performance (1080i50):

The maximum number of DVE Assets (excluding Fore- and Background layer) on **xMio2+** for each single channel :

Size	Maximum
100%	2(3)
99%	2(3)
33%	3 (Break even point ~90%)

The maximum number of DVE Assets (excluding Fore- and Background layer) on **xMio3** for each single channel:

Size	Maximum
100%	4
99%	4
33%	4

* These measurements are done with DSX Utils 9.8.0.22112 on Viz Engine 3.9.0.66266.

13 BlueFish444

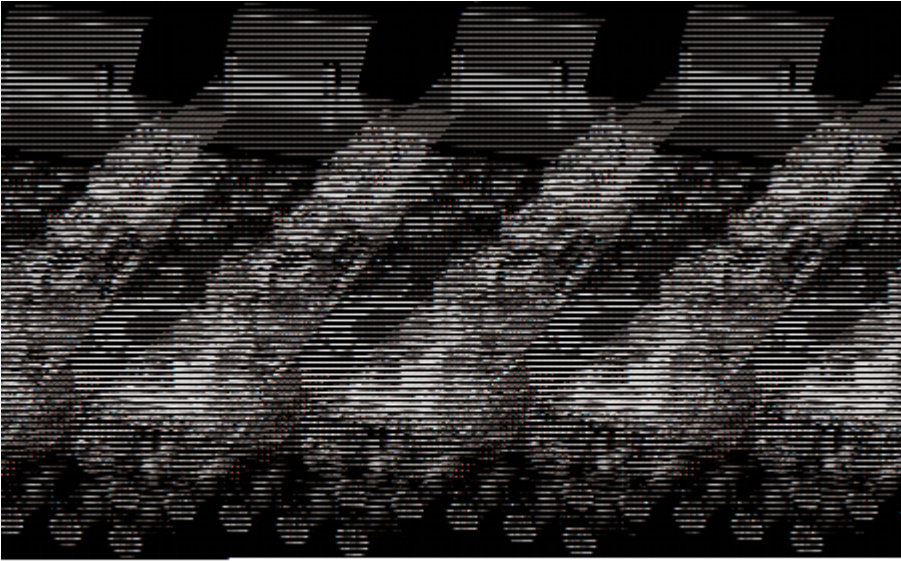

Viz Engine supports the following BlueFish444 video boards:

- Epoch | 4K Supernova
- Epoch | 4K Supernova S+
- Epoch | Supernova CG
- Epoch | Neutron (introduced in Viz version 3.7.0)

Since Viz version 3.5 and later, these boards replace the SD Lite Pro Express, which is considered a legacy board but will work for Viz 3.5 installations. Some of the main supported features are:

- Embedded audio input and output. Note that all 16 channels are used; however, there are currently no configuration options available for these channels (e.g. routing of channels, enable/disable channels etc)
- ANC data (both HANC and VANC), such as VITC and RP188 time codes, is supported. Data from the input is laid over the output. Ingestion of time codes from time code reader boards is supported as well
- Two video inputs and outputs and one Genlock
- Automatic bypass (aka [Special Configuration Options for Bluefish444](#)) of video if the Viz Engine crashes
- Constant delay of 4 frames from input to output

Note: Other BlueFish444 and Digital Voodoo boards are no longer supported (see the [Legacy Cards](#) section).

13.1 Epoch | 4K Supernova, Epoch | 4K Supernova S+ and Epoch | Supernova CG

The BlueFish444 Epoch | 4K Supernova, Epoch | 4K Supernova S+ and Epoch | Supernova CG boards are intended for character generators such as Viz Trio, but can also be used as an alternative where only two inputs and outputs are required. The boards are typically installed on HP Z800 machines.

This section contains information on the following:

- [Epoch | 4K Supernova](#)
 - [Epoch | 4K Supernova Connectors](#)
- [Epoch | 4K Supernova S+](#)
 - [Epoch | 4K Supernova S+ Connectors](#)
- [Epoch | Supernova CG](#)
 - [Epoch | Supernova CG Connectors](#)

13.1.1 Epoch | 4K Supernova

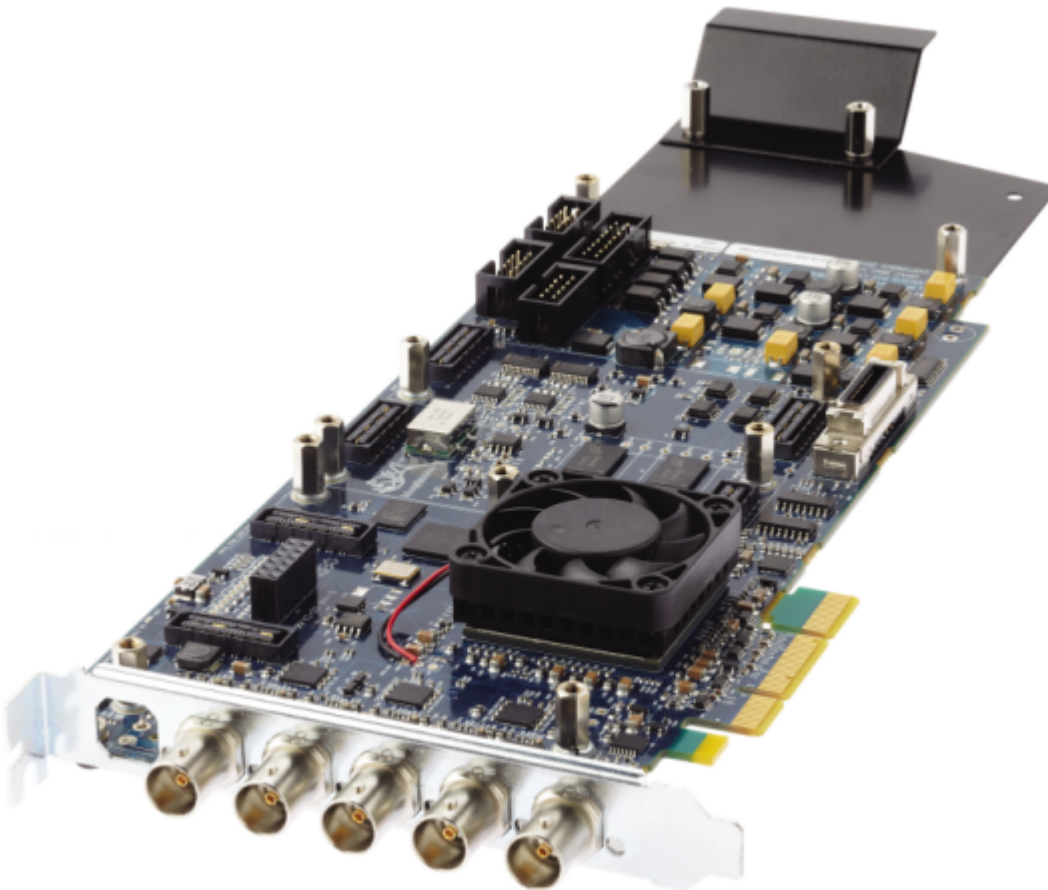

The Epoch | Supernova is a full-length PCIe card with five bi-directional multi-format I/O BNC connectors that support a number of configurations with up to two dual link channels or four single link channels. For use with Viz Engine, the card needs to be configured with two inputs and two outputs.

Epoch | 4K Supernova Connectors

With 5 BNC connectors, each of the first four do SD, HD, 3G, ASI, AES and LTC as either input or output. The fifth is the designated GenLock or SD, HD, 3G, ASI or AES (no LTC).

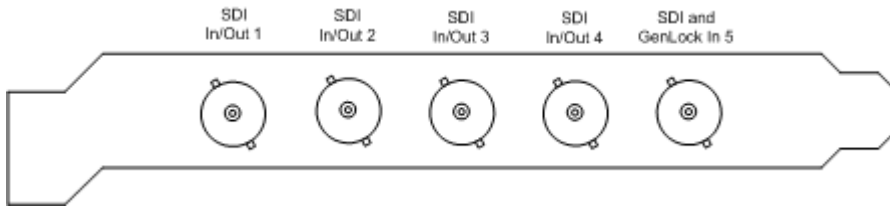

On the Epoch | 4K Supernova, the default connector configuration for the five connectors are:

- Output 1
- Input 1
- Output 2
- Input 2
- Reference In (Genlock)

If the `dual_link_input` flag is set to 1 in the Viz Configuration file, the two inputs are treated as one channel with fill on the first and key on the second. Please refer to the [Special Configuration Options for Bluefish444](#) section for more information.

See Also

- [Configuration History for BlueFish444](#)
- [Special Configuration Options for Bluefish444](#)
- [Video, Audio, Server and Graphics Card Installation](#)
- [Video Board](#)

13.1.2 Epoch | 4K Supernova S+

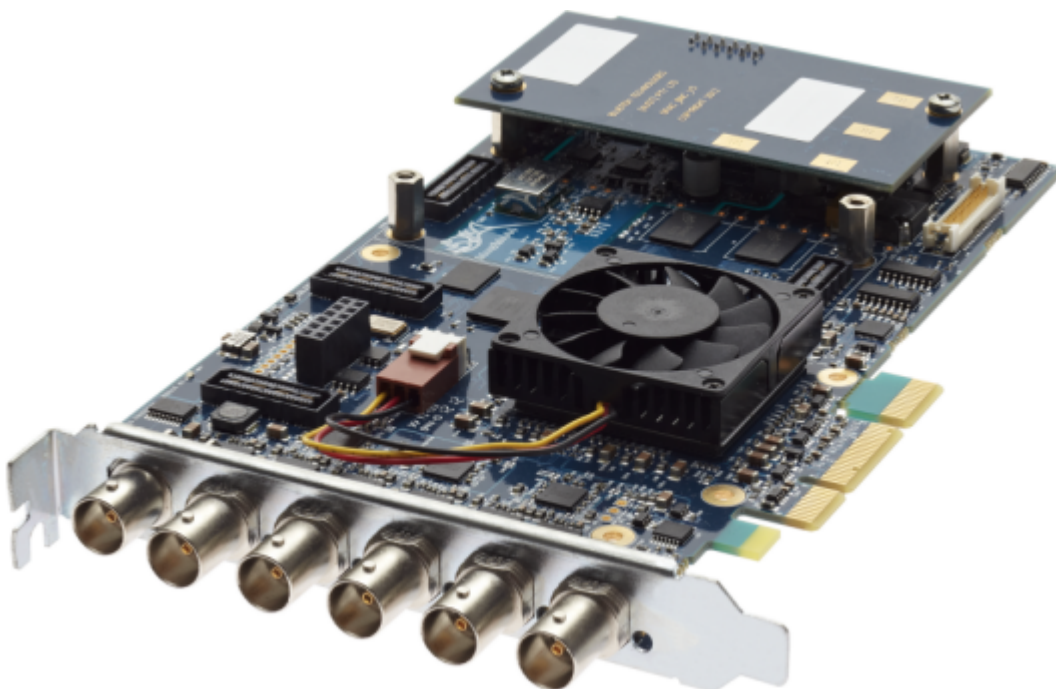

The Epoch | Supernova S+ is a 2/3-length PCIe card with bi-directional multi-format I/O BNC connectors that support a number of configurations, up to two dual link channels or four single link channels. For use with Viz Engine, the card needs to be configured with two inputs and two outputs. With six BNC connectors, each of the first four do SD, HD, 3G, ASI, AES and LTC as either input or output. The fifth is the designated GenLock or SD, HD, 3G, ASI or AES (no LTC).

Epoch | 4K Supernova S+ Connectors

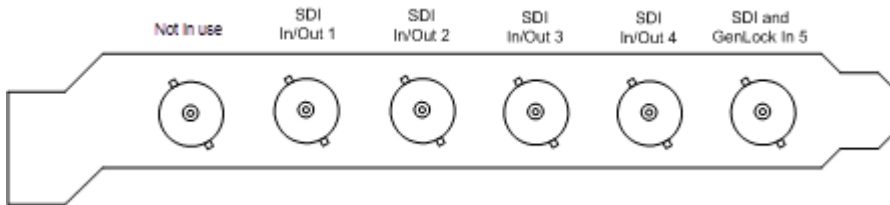

On the Epoch | 4K Supernova S+, the default connector configuration for the six connectors are:

- *Not in use*
- Output 1
- Input 1
- Output 2
- Input 2
- Reference In (Genlock)

.....
Note: Viz Engine does not utilize the top BNC connector on the Epoch | 4K Supernova S+ video card, recognized as not being flush with the other five.
.....

If the `dual_link_input` flag is set to 1 in the Viz Configuration file, the two inputs are treated as one channel with fill on the first and key on the second. Please refer to the [Special Configuration Options for Bluefish444](#) section for more information.

See Also

- [Configuration History for BlueFish444](#)
- [Special Configuration Options for Bluefish444](#)
- [Video, Audio, Server and Graphics Card Installation](#)
- [Video Board](#)

13.1.3 Epoch | Supernova CG

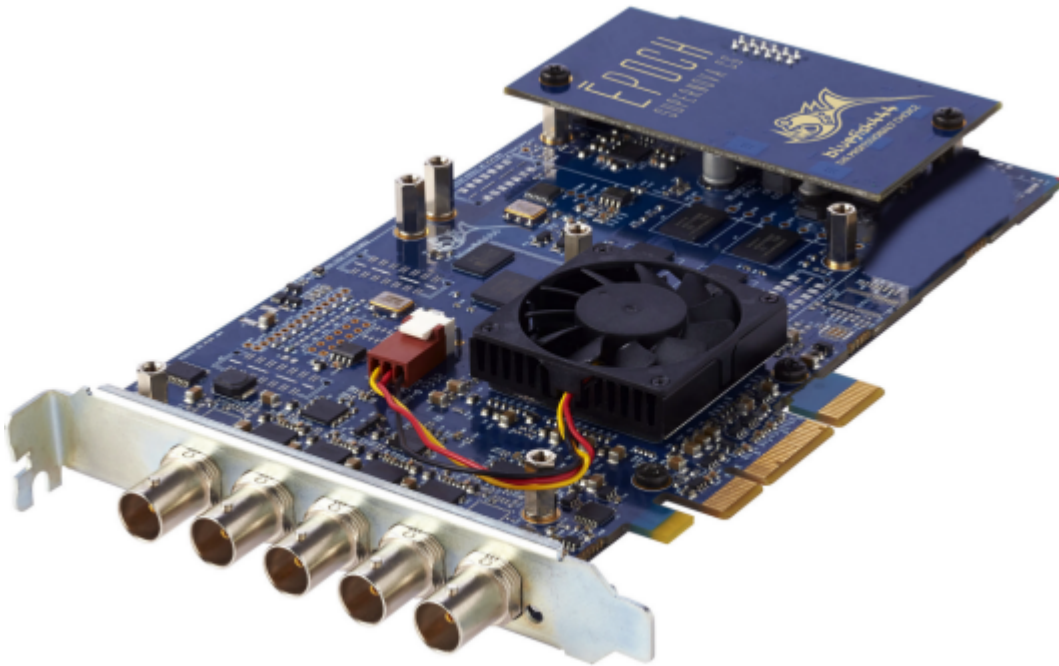

The Epoch | Supernova CG is a 2/3-length PCIe card with bi-directional multi-format I/O BNC connectors that support a number of configurations, up to two dual link channels or four single link channels. For use with Viz Engine, the card needs to be configured with two inputs and two outputs. With five BNC connectors, each of the first four do SD, HD, 1.5G, ASI, AES and LTC as either input or output. The fifth is the designated GenLock or SD, HD, 1.5G, ASI or AES (no LTC).

Epoch | Supernova CG Connectors

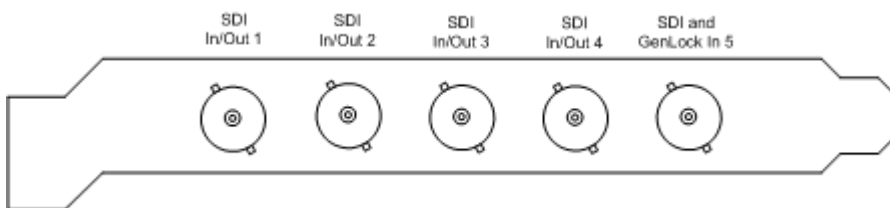

On the Epoch | Supernova CG, the default connector configuration for the five connectors are:

- Output 1
- Input 1
- Output 2
- Input 2
- Reference In (Genlock)

If the `dual_link_input` flag is set to 1 in the Viz Configuration file, the two inputs are treated as one channel with fill on the first and key on the second. Please refer to the [Special Configuration Options for Bluefish444](#) section for more information.

See Also

- [Configuration History for BlueFish444](#)
- [Special Configuration Options for Bluefish444](#)
- [Video, Audio, Server and Graphics Card Installation](#)
- [Video Board](#)

13.2 Epoch | Neutron



The Epoch | Neutron is a full-length PCIe card with three bi-directional multi-format I/O BNC connectors that support dual link configurations. For use with Viz Engine, the card needs to be configured with one input and one output. Of the three BNC connectors, the first two do SD, HD, 1.5G, ASI, AES and LTC as either input or output. The third is used for GenLock.

.....
Tip: The Epoch | Neutron is capable of downstream keying. To achieve this, add a Media Asset as DVE when creating a scene in Viz Artist.
.....

13.2.1 Epoch | Neutron Connectors

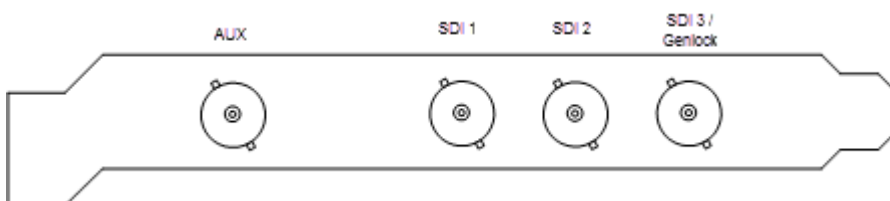

On the Epoch | Neutron, the default connector configuration for the four connectors are:

- AUX connector (Not Used)
- (empty space)
- Output 1 (fill)
- Input 1
- Reference IN

If the `dual_link_output` flag is set to 1 in the Viz configuration file, the key output is enabled on the bottom BNC connector. The Genlock signal gets moved to the AUX connector at the top.

- Reference In
- (empty space)
- Output 1 (fill)
- Input 1
- Output 2 (key)

Please refer to the [Special Configuration Options](#) section for more information.

See Also

- [Configuration History for BlueFish444](#)
- [Special Configuration Options](#)
- [Video, Audio, Server and Graphics Card Installation](#)
- [Video Board](#)
- [Media Assets as DVE in the Viz Artist Guide](#)

13.3 Configuration History for BlueFish444

Use the driver version available on Vizrt's FTP server to make sure of correct functionality and ring buffer support.

<ftp://download.vizrt.com>

13.3.1 The following driver and firmware versions are supported:

Viz Release	Driver Version	Supernova Firmware	Neutron Firmware
3.8.1 - 3.8.2	5.11.0.39	2i2o 134	1i1o 025
3.8.0	5.11.0.25	2i2o 127	1i1o 067
3.7.1	5.11.0.14	2i2o 108	1i1o 054
3.7.0	5.11.0.7	2i2o 096 Rev. 2	1i1o 016 Rev. 2
3.6.4	5.11.0.3	2i2o 096	N/A
3.6.3	5.10.2.18	2i2o 094	N/A
3.6.1 - 3.6.2	5.10.2.4	2i2o 053	N/A
3.5.1 - 3.5.4	5.10.1.11	2i2o 031	N/A

Viz Release	Driver Version	Supernova Firmware	Neutron Firmware
3.5.0	5.9.0.78	442	N/A

13.4 Special Configuration Options for Bluefish444

This section describes the procedures to configure the following options when running a Bluefish444 setup:

- [To Enable Dual Link Input for Epoch | 4K Supernova and Epoch | 4K Supernova S+ Boards](#)
- [To Enable Dual Link Output for Epoch | Neutron](#)
- [To Enable Automatic Bypass for BlueFish444 Epoch Boards](#)

13.4.1 To Enable Dual Link Input for Epoch | 4K Supernova and Epoch | 4K Supernova S+ Boards

1. Stop Viz Engine.
2. Open the **Viz Configuration file** (for example: *VIZ-<hostname>-0-0.cfg*)

.....
Note: The default location for this file is %ProgramData%\Vizrt\Viz3

3. Locate SECTION VIDEO.
4. Enable the **Dual Link Input** setting by changing the default value 0 to 1:

```
dual_link_input = 1
```

5. Save the file
6. Start Viz Engine

13.4.2 To Enable Dual Link Output for Epoch | Neutron

1. Stop Viz Engine.
2. Open the **Viz Configuration file** (for example: *VIZ-<hostname>-0-0.cfg*)

.....
Note: The default location for this file is %ProgramData%\Vizrt\Viz3

3. Locate SECTION VIDEO.
4. Enable the **Dual Link Output** setting by changing the default value 0 to 1:

```
dual_link_output = 1
```

5. Save the file
6. Start Viz Engine

13.4.3 To Enable Automatic Bypass for BlueFish444 Epoch Boards

Viz Engine supports automatic mechanical bypass (copper-to-copper) of video for BlueFish444 Epoch boards. To use this feature enable the feature.

1. Stop Viz Engine.
2. Open the **Viz Configuration file** (for example: *VIZ-<hostname>-0-0.cfg*)

Note: The default location for this file is %ProgramData%\Vizrt\Viz3

3. Locate SECTION VIDEO.
4. Enable the Watchdog setting by changing the default value 0 to 1:

```
video_use_watchdog = 1
```

5. Save the file
6. Start Viz Engine

See Also

- [Configuration History for BlueFish444](#)
- [Video, Audio, Server and Graphics Card Installation](#)
- [Video Board](#)

14 Digital Video Systems

This section describes the Digital Video Systems (DVS) video boards and drivers supported by Viz Engine.

This section contains information on the following topics:

- [DVS Atomix HDMI](#)
- [DVS Atomix LT](#)

14.1 DVS Atomix HDMI

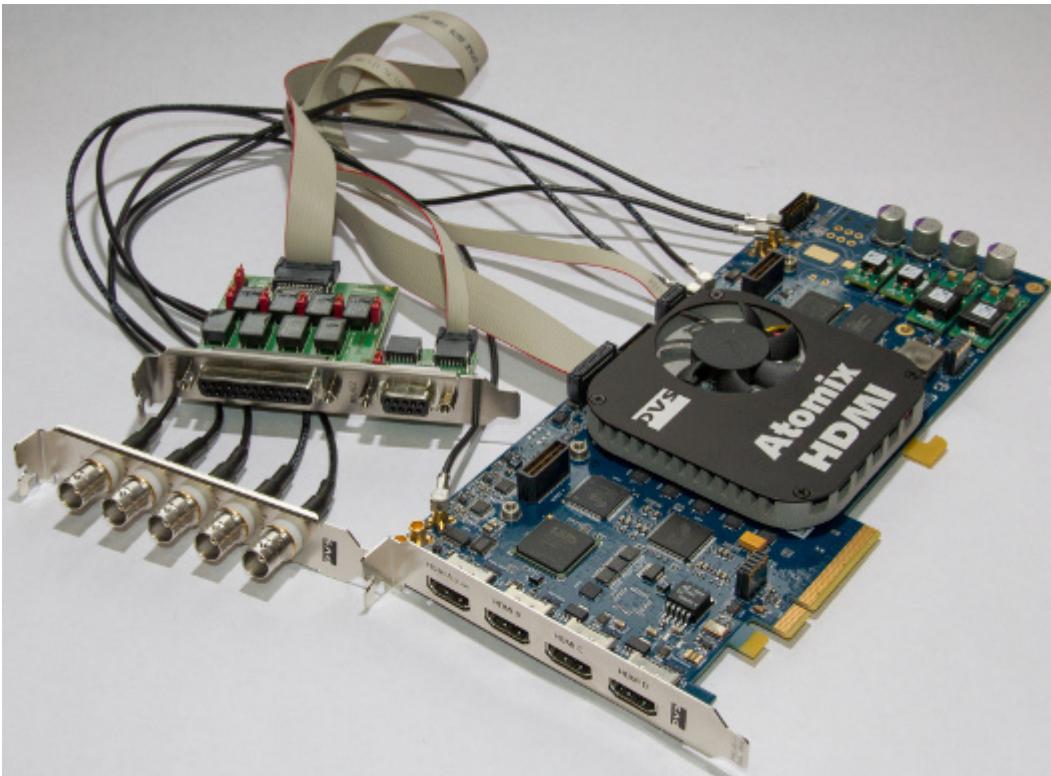

This section contains a description of the Digital Video Systems' (DVS) Atomix HDMI video board.

Atomix HDMI is designed for HD TV broadcast and film post production up to 2K. Atomix HDMI features two video channels that can be used independently or in 3D/stereo mode up to 2K. Moreover, it has an up/downscaler, a 1D LUT and multi-rate SDI ports with 3.0 Gbps which can be used in various single- and dual-link configurations.

The DVS Atomix HDMI is mainly used with Viz Virtual Set and Viz Arena, and is the successor of the DVS Centaurus II. The DVS Atomix HDMI is, as with the Centaurus II, able to output SD, HD and 2K.

The DVS Atomix HDMI is typically mounted in HP Z420 machines.

This section contains information on the following topics:

- Connectors
 - Component Side
 - SDI Panel
 - Audio and RS-422 panel
- Supported Codecs
- Configuration History
- Licensing

See Also

- Video, Audio, Server and Graphics Card Installation
- DVS support

14.1.1 Connectors

Component Side

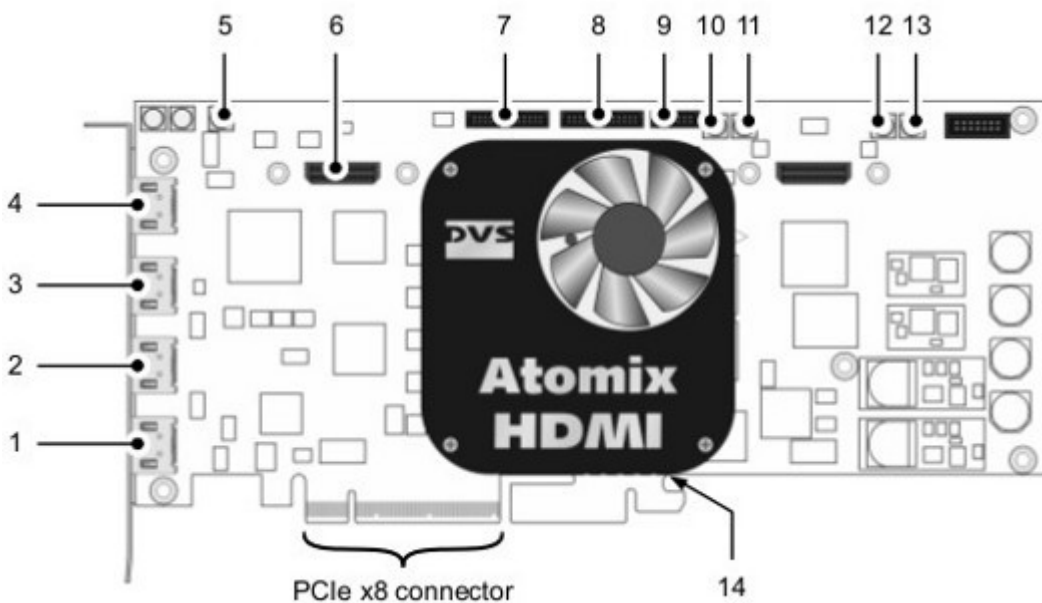

This section is an excerpt from the **DVS Atomix HDMI Installation Guide (version 2)**, section 2.2.2, *Overview of the Component Side*, and section 2.3.3, *Audio and RS-422 Panel*. For complete information, see the DVS Installation Guide available for download on their website.

No.	Item	Description
1	HDMI D	HDMI 1.3 connector for an output of digital audio and video signals; will be used for the first video channel in special rasters (e.g. for quad-display applications)
2	HDMI C	

No.	Item	Description
3	HDMI B	HDMI 1.3 connector for an output of digital audio and video signals (main port of the assigned video channel); usually used for the second video channel; can also be used for the first video channel in special rasters (e.g. for quad display applications)
4	HDMI A (1.4a)	HDMI 1.3 connector for an output of digital audio and video signals; will be used for the first video channel in special rasters (e.g. for quad-display applications)
4	HDMI A (1.4a)	HDMI 1.4a connector for an output of digital audio and video signals up to 4K (main port of the assigned video channel); usually used for the first video channel
5	Ref In	MXC connector for the reference input
6	Expansion	Connection for an expansion module or slot panel
7	AUDIO 1-8/LTC	Flat cable connector for analog audio, the digital audio channels 1 to 8 and LTC
8	AUDIO 9-16	Flat cable connector for the digital audio channels 9 to 16
9	RS-422 A/B	Flat cable connector for an in- and output of RS-422 signals (main remote ports)
10	SDI OUT A	MCX connector for an output of digital video signals (serial digital interface, port A); usually used for an output of the first video channel in single-link (YUV) or dual-link modes (either 3-Gbit/s SDI or first dual-link stream of YUVA or RGB [A])
11	SDI IN A	MCX connector for an input of digital video signals (serial digital interface, port A); usually used for an input of the first video channel in single-link (YUV) or dual-link

No.	Item	Description
12	SDI IN B	<p>modes (either 3-Gbit/s SDI or first dual-link stream of YUVA or RGB [A])</p> <p>MCX connector for an input of digital video signals (serial digital interface, port B); usually used for an input of the second video channel in single-link (YUV) or dual-link modes (3-Gbit/s SDI); can also be used for the first video channel for the second dual-link stream of YUVA or RGB[A]</p>
13	SDI Out B	<p>MCX connector for an output of digital video signals (serial digital interface, port B); usually used for an output of the second video channel in single-link (YUV) or dual-link modes (3-Gbit/s SDI); can also be used for the first video channel for the second dual-link stream of YUVA or RGB[A]</p>
14	breaking line	<p>The printed circuit board provides at its bottom an extension void of any electrical parts; it may serve to stabilize the installation of the board in a computer system; when not needed or interfering, you can carefully break it off the circuit board at the breaking line</p>

SDI Panel

The SDI panel provides the serial digital interface connectors for Atomix HDMI:

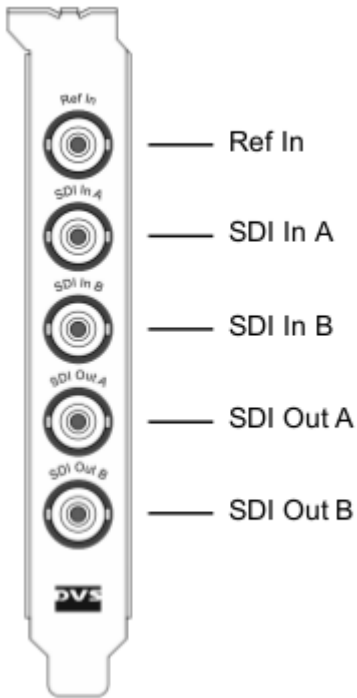

Item	Description
Ref In	BNC connector for the reference input
SDI In A	BNC connector for an input of digital video signals (serial digital interface, port A); usually used for an input of the first video channel in single-link (YUV) or dual-link modes (either 3-Gbit/s SDI or first dual-link stream of YUVA or RGB[A])
SDI In B	BNC connector for an input of digital video signals (serial digital interface, port B); usually used for an input of the second video channel in single-link (YUV) or dual-link modes (3-Gbit/s SDI); can also be used for the first video channel for the second dual-link stream of YUVA or RGB [A]
SDI Out A	BNC connector for an output of digital video signals (serial digital interface, port A); usually used for an output of the first video channel in single-link (YUV) or dual-link modes (either 3-Gbit/s SDI or first dual-link stream of YUVA or RGB[A])
SDI Out B	BNC connector for an output of digital video signals (serial digital interface, port B); usually used for an output of the second video channel in single-link (YUV) or dual-link modes (3-Gbit/s SDI); can also be used for the first video channel for the second dual-link stream of YUVA or RGB[A]

Audio and RS-422 panel

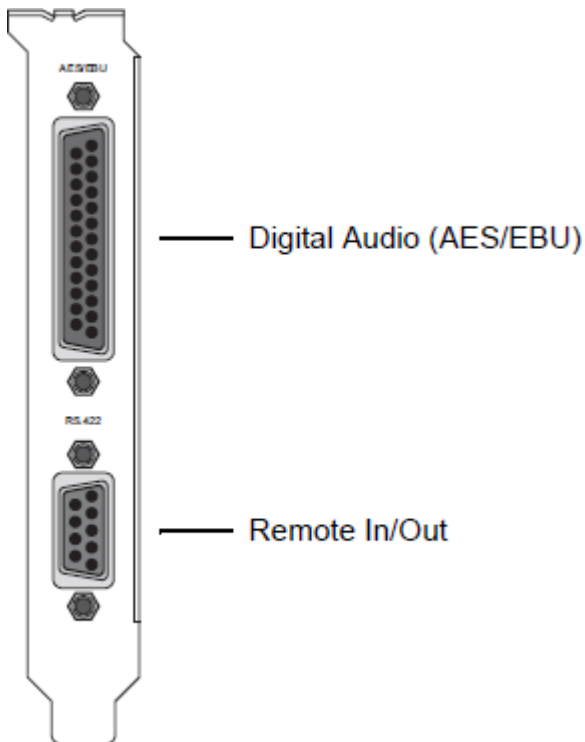

The board has the breakout cable, a RS-422 panel and cable. On the RS-422 panel there are two connectors:

Item	Description
Digital Audio (AES/EBU):	DB-25 connector (female) for audio and LTC in- and output; provides either four stereo channels digital audio (channels 1 to 8) or three channels audio plus LTC. It can also be used to provide the digital audio channels 9 to 16.
Remote In/Out:	DB-9 connector (female), serial RS-422 interface for master or slave control.

The breakout cable has 4 XLR male and 4 XLR female connectors to interface directly with audio devices. The RS-422 panel's cable is mounted on the back of the RS-422 panel's board and connected to the Atomix HDMI board.

14.1.2 Supported Codecs

Currently, the DVS Atomix HDMI implementation only supports the **Microsoft DirectShow Filtergraph** framework to render video clips. This enables play, for example, of MPEG files or streams from a server.

Basically the DVS Atomix HDMI board can play everything that can be played out by the Windows Media Player, so it depends on what codecs/DirectShow filters that are installed on the machine.

For more information on how to use video clips in Viz Artist, see the [Viz Artist User Guide](#) and, in particular, the SoftClip and MoViz plug-ins.

See Also

- [Supported Codecs](#) in the [Viz Artist User Guide](#)

14.1.3 Configuration History

Use the driver version available on Vizrt's FTP server to make sure of correct functionality and ring buffer support.

The following driver versions are supported:

Viz Release	Driver Version
3.5.4 and later	SDK 4.3.5.10 (firmware7.4.0.20_7.0.10)
3.5.2 - 3.5.3	SDK 4.2.9.8 (firmware 7.4.0.6_7.0.10)

For information on how to install or update the driver, see the DVS SDK 2.7 User Guide (version 2.0) sections 3.2 and 3.3: *Installation under Windows* and *Updating an Existing SDK*.

14.1.4 Licensing

For information on how to set the license key for the DVS Atomix HDMI board, see the DVS Atomix HDMI installation guide, section 3.3: *Setting the License Key*.

14.2 DVS Atomix LT

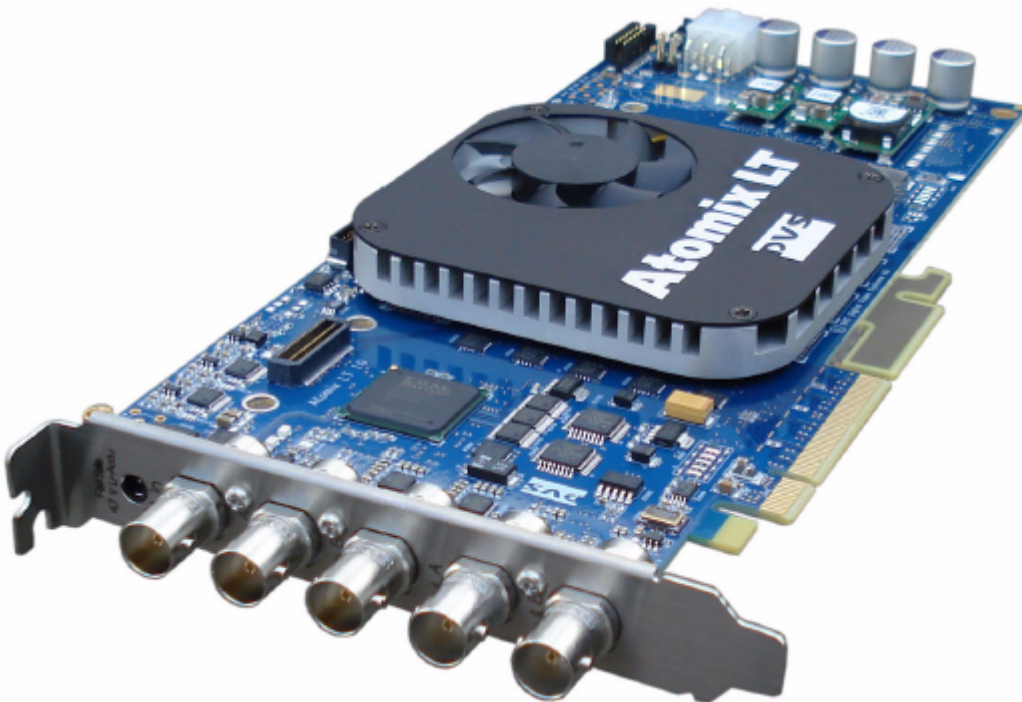

This section contains a description of the Digital Video Systems' (DVS) Atomix LT video board.

Atomix LT is designed for HD TV broadcast and film post production up to 2K. Atomix LT features two video channels that can be used independently or in 3D/stereo mode up to 2K. Moreover, it has an up/downscaler, a 1D LUT and multi-rate SDI ports with 3.0 Gbps which can be used in various single- and dual-link configurations.

Vizrt's use of the DVS is mainly used with Viz Virtual Set and Viz Arena, and is Vizrt's successor of the DVS Centaurus II. The DVS Atomix LT is as with the Centaurus II able to output SD, HD and 2K. The DVS Atomix is typically mounted in HP Z800 machines.

This section contains information on the following topics:

- [Connectors](#)
 - [Overview of the items and connectors on the DVS Atomix LT board](#)
 - [Panel with audio and remote control connections](#)
- [Supported Codecs](#)
- [Configuration History for DVS](#)
- [Licensing](#)

See Also

- [Video, Audio, Server and Graphics Card Installation](#)
- [DVS support](#)

14.2.1 Connectors

Overview of the items and connectors on the DVS Atomix LT board

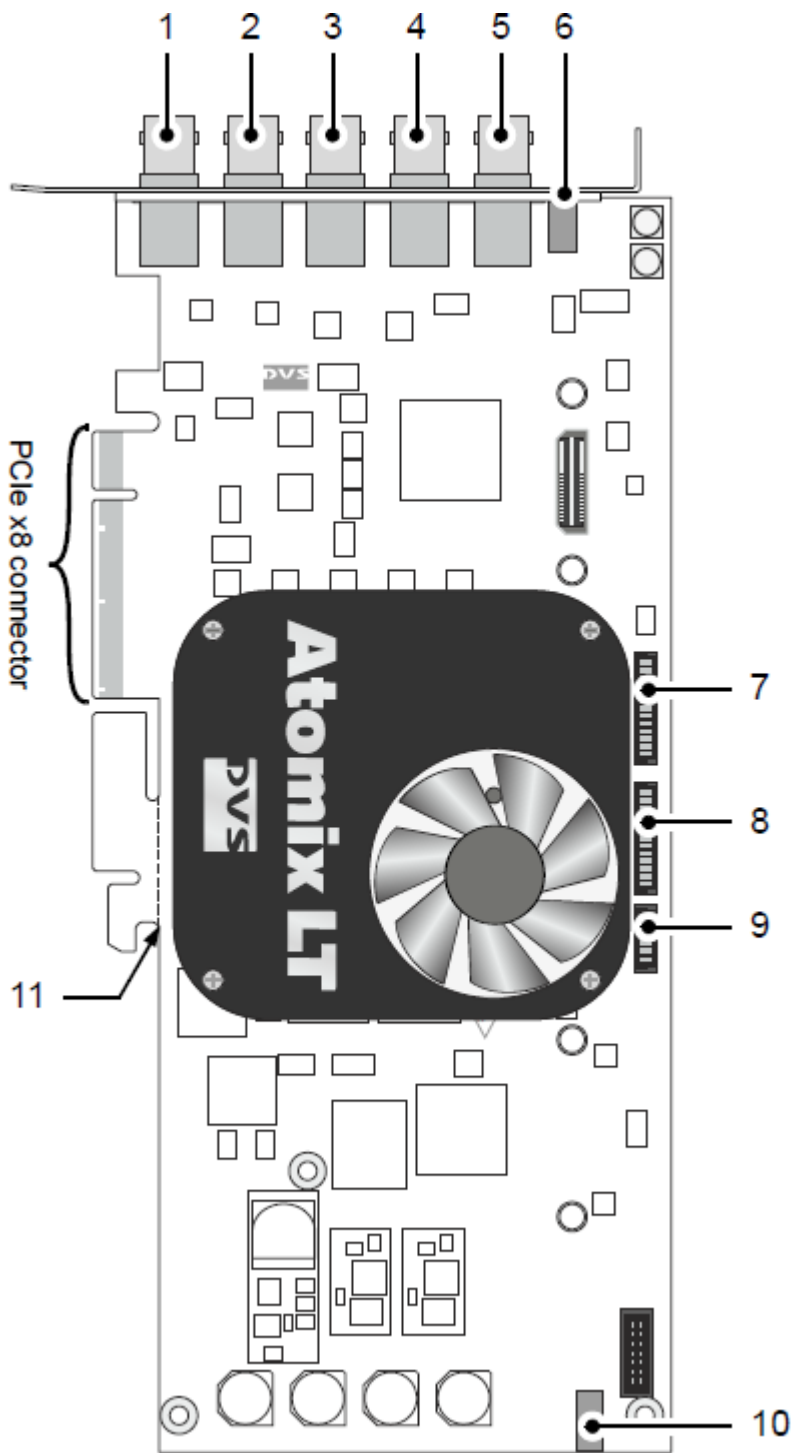

This section is an excerpt from the **DVS Atomix LT installation guide** (version 1.0) section 2.2.1 and 2.3.2: *Overview of the Component Side and Audio _and RS-422 Panel_*. For complete information, please refer to DVS' installation guide available for download on their website.

No.	Item	Explanation
1	SDI Out B	BNC connector for an output of digital video signals (serial digital interface, port B); usually used for

No.	Item	Explanation
2	SDI Out A	an output of the second video channel in single-link (YUV) or dual-link modes (3-Gbit/s SDI); can also be used for the first video channel for the second dual-link stream of YUVA or RGB[A]
3	SDI In B	BNC connector for an output of digital video signals (serial digital interface, port A); usually used for an output of the first video channel in single-link (YUV) or dual-link modes (either 3-Gbit/s SDI or first dual-link stream of YUVA or RGB [A])
3	SDI In B	BNC connector for an input of digital video signals (serial digital interface, port B); usually used for an input of the second video channel in single-link (YUV) or dual-link modes (3-Gbit/s SDI); can also be used for the first video channel for the second dual-link stream of YUVA or RGB[A]
4	SDI In A	BNC connector for an input of digital video signals (serial digital interface, port A); usually used for an input of the first video channel in single-link (YUV) or dual-link modes (either 3-Gbit/s SDI or first dual-link stream of YUVA or RGB [A])
5	Ref In	BNC connector for the reference input
6	Fail Safe 0	See Fail Safe 1
7	AUDIO 1-8/LTC	Flat cable connector for analog audio, the digital audio channels 1 to 8 and LTC
8	AUDIO 9-16	Flat cable connector for the digital audio channels 9 to 16
9	RS-422 A/B	Flat cable connector for an in- and output of RS-422 signals (main remote ports)
10	Fail Safe 1	

No.	Item	Explanation
11	Breaking line	<p>For a bypass of the SDI input signals to the SDI outputs in case of power loss connect to either this connector or Fail Safe 0 a rechargeable battery (accu, see section “Technical Data” on page A-1)</p> <p>The printed circuit board provides at its bottom an extension void of any electrical parts; it may serve to stabilize the installation of the board in a computer system; when not needed or interfering, you can carefully break it off the circuit board at the breaking line</p>

Panel with audio and remote control connections

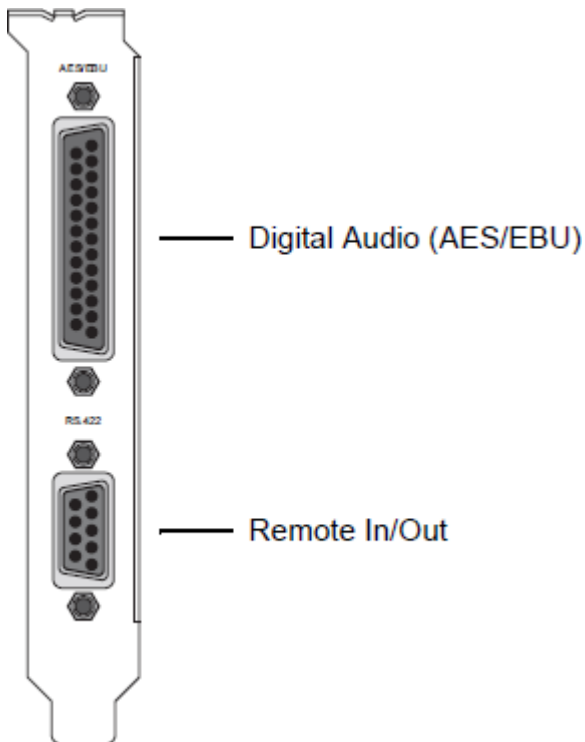

With the board you also have the breakout cable, RS-422 panel and cable. On the RS-422 panel there are two connectors, one DB-25 connector for digital audio (AES/EBU) and one DB-9 connector for remote in/out.

Item	Explanation
Digital Audio (AES/EBU)	

Item	Explanation
	DB-25 connector (female) for audio and LTC in- and output; provides either four stereo channels digital audio (channels 1 to 8) or three channels audio plus LTC; alternatively it can be used to provide the digital audio channels 9 to 16.
Remote In/Out	DB-9 connector (female), serial RS-422 interface for master or slave control.

The breakout cable has 4 XLR male and 4 XLR female connectors to interface directly with audio devices. The RS-422 panel's cable is mounted on the back of the RS-422 panel's board and connected to the Atomix LT board.

14.2.2 Supported Codecs

Currently, the DVS implementation only supports the **Microsoft DirectShow Filtergraph** framework to render video clips. This enables you to play for example MPEG files or streams from a server.

For more information on how to use video clips in Viz Artist, see the [Viz Artist User Guide](#) and in particular the SoftClip and MoViz plugins.

Basically the DVS board can play everything that can be played out by the Windows Media Player, so it depends on what codecs/DirectShow filters that are installed on the machine.

14.2.3 Configuration History for DVS

The following driver versions are supported:

Viz Release	Driver Version
3.5.4 and later	SDK 4.3.5.10
3.5.2 - 3.5.3	SDK 4.2.9.8
3.3.0 - 3.5.1	SDK 4.0.1.15

For information on how to install or update the driver, please refer to DVS' SDK 2.7 user guide (version 2.0) sections 3.2 and 3.3: *Installation under Windows* and *Updating an Existing SDK*.

14.2.4 Licensing

For information on how to set the license key for your DVS Atomix LT board, please refer to the DVS Atomix LT installation guide (version 1.0) section 3.3: *Setting the License Key*.

15 NVIDIA Quadro SDI Capture



Currently the NVIDIA Quadro SDI Capture card can only be used with the NVIDIA SDI option. Vizrt's application of this card is mainly in time critical environments like virtual studios and sports applications as it has a stable latency from input to output (of 4 frames).

The time used for video transfer from input to the GPU and back to video output is a lot less than any other solution Vizrt currently offers. Hence, scenes with 4 video inputs as texture still have a lot of rendering time left per field/frame.

15.1 Connectors

The card has five BNC connectors. Four connectors are used for input, and the fifth connector serves as a loop-through of input one.

15.2 Drivers for NVIDIA Quadro SDI capture card

Use the latest NVIDIA GPU driver and WDM (Windows Driver Model) driver for the capture card. Vizrt does not recommend a specific driver version beyond using the latest version available from NVIDIA.

See Also

- Compatible and recommended NVIDIA SDI out cards supported by Vizrt:
 - NVIDIA Quadro FX 4400

- NVIDIA Quadro FX 5500
- NVIDIA Quadro K5000
- Available machine configurations:
 - HP DL370

16 AJA Io 4K

Viz 3.7.1 and later supports the AJA Io 4K (Io4K), a portable size professional video and audio I/O solution.

Io4K supports 4K, UltraHD, 3G-SDI, Dual Link, HD-SDI and SD-SDI as well as UHD and HD over HDMI 1.4a for both capture and output. A dedicated, real time, always-on HD-SDI output allows Io 4K to simultaneously output to HD monitors when working at 4K or UHD resolutions, providing cost-effective monitoring options in addition to full resolution outputs.

.....
IMPORTANT! All possible modes of operation for the AJA Io 4K is currently **not** supported by Viz Engine, see [Configuration](#).
.....

This section contains information on the following topics:

- [Overview and Connectors](#)
- [Configuration](#)
- [AJA Io 4K Features and Specifications](#)
 - [Features:](#)
 - [Technical Specifications](#)
- [Configuration History](#)

See Also

- [Video, Audio, Server and Graphics Card Installation](#)
- Manufacturer's documentation (external link at www.aja.com): [AJA Io 4K](#)



16.1 Overview and Connectors

Io4K supports your current SD and HD SDI workflow and also provides support for future UltraHD and 4K (with downscaling, if needed) with frame rates up to 50p/60p whenever the need arises.

Embedded 16-channel SDI and 8-channel HDMI audio are supported as well as analog audio outputs via a standard DB-25 connection. Stereo monitoring is also possible with 2 x RCA outputs and a front panel mini-TRS headphone jack.

16.2 Configuration

IMPORTANT! Currently 4K and HDMI output is not supported. Support for this will be considered in future Viz Engine releases. For 1080P only Level A for 3G is supported.

This section contain information about the following subjects:

- [Audio configuration](#)
- [Video Configuration](#)
- [Configuration Utilities](#)
- [Firmware Upgrade](#)

16.3 Audio configuration

Embedded audio is supported, always with 16 channels in and out. However, mixer settings are active, and respected. Example: if the user requests only two-channel output, the remaining 14 channels will be silent.

16.4 Video Configuration

The six BNC connectors on the back of the Io4K are labeled [LTC OUT], [LTC IN/REF IN] and [SDI 1 to 4] as indicated in the picture below:

The default configuration is:

Viz Reference	Io4K BNC Connector
Live Input 1	SDI 1
Live Input 2	SDI 2
Fill Output exits from:	SDI 3
Key Output exits from:	SDI 4
Genlock	[REF IN]

If Live Input 2 is inactive in the configuration, SDI 2 will be enabled for preview output.

16.5 Configuration Utilities

Vizrt includes two configuration utilities from AJA:

- **cables.exe** This utility shows the current topology running: inputs, outputs, color space conversion, fill and key paths. Firmware and driver version information is also accessible. Screen-shots of cables.exe usage showing two typical topologies (**A**: two video inputs and **B**: one video and one preview) are shown below

Example A- topology using two video inputs:

Example **B**- One video input, one preview:

- **watcher.exe** This utility shows register settings. You may also write out a status log file. The auto-circulate engine is also observable. This utility is mostly of value for support specialists.

16.6 Firmware Upgrade

Only do an upgrade of Io4K firmware if instructed to do so by Vizrt or AJA support. All files for firmware upgrade will be provided in a separate directory, typically supplied as a zip-archive. To install the firmware:

1. Open a command window.
2. `cd` to the directory where the firmware upgrade files are located. Make sure no other programs are running that could interfere with the firmware upgrade.
3. Install the firmware, in this example named `IO_XT_4K_13.bit`, using the `ntv2firmwareinstaller` utility. Example: `ntv2firmwareinstaller -f IO_XT_4K_13.bit`
4. The window will then pause for a few minutes. When the firmware upgrade is complete, the command line program will ask for a return key press to exit. Please be patient, the firmware upgrade can take 3 to 6 minutes or more, depending on hardware.

5. Power-cycle the Io4K and reboot the computer to make sure the upgraded firmware configuration is active.

16.7 AJA Io 4K Features and Specifications

The Io4K features and specifications as provided by the manufacturer are provided for your reference below.

[Configuration](#) describes the modes of operation Viz Engine supports.

16.7.1 Features:

- 4 x bi-directional 3G-SDI
- 4K/UHD HDMI I/O
- Simultaneous SDI and HDMI outputs
- Real time 4K to HD down-conversion for HD-SDI and HDMI monitoring
- 10-bit high-quality 4:2:2, 4:4:4 and High Frame Rate work-flow support
- Two Thunderbolt 2 ports
- Use with any Thunderbolt 2 system for up to 4K at 10-bit quality and up to 50p/60p
- Backwards compatible with existing Thunderbolt hosts
- 16-channel embedded audio on SDI
- 8-channel embedded audio on HDMI
- DB-25 analog audio output connector
- XLR 12V power for battery or AC use
- RS-422 VTR control, Reference, LTC Input
- Headphone jack and level control for mobile environments

16.7.2 Technical Specifications

For the full technical specifications, visit the manufacturers website at www.aja.com - [Io4K Tech Specs](#).

16.8 Configuration History

The AJA Io 4K requires Viz Engine 3.7.1 or higher, with the following driver and firmware:

- Driver version 12.0.0.123
- Firmware version 13

17 Video, Audio, Server and Graphics Card Installation

The installation of video, audio or graphics cards, is not required on a new system. However, for maintenance or upgrades, it is important to know how to do the installation for the different models.

All servers are pre-configured with Windows 7 Pro 64-bit, except the [HP DL360 Gen9](#) which is configured with Windows Server 2008 R2.

This section mainly describes how to install BlueFish, DVS and Matrox X.mio series cards with an NVIDIA graphics card. The following machines are covered:

- [HP Z440](#)
- [HP Z840](#)
- [HP DL360 Gen9](#)
- [HP DL380 Gen9](#)
- [Dell R7910 \(2U\) Rack Server](#)
- [Supermicro SuperServer 7048 GR-TR](#)
- [HP ZBook 15/17 G3 Mobile workstation](#)

Information on how to replace a Matrox X.mio board and connect an audio-extension card can be found in the [Matrox](#) chapter.

.....
IMPORTANT! Be careful when handling cards, see [Handling and installing cards](#) for some advice.
.....

Deprecated / legacy servers - for reference only:

- [HP Z420](#)
- [HP DL370](#)
- [HP DL360 Gen9](#)
- [HP DL370](#)
- [HP xw8200](#)
- [HP xw8400](#)

See Also

- [NVIDIA Graphics Cards](#)
- [BlueFish444](#)
- [Digital Video Systems](#)
- [Matrox](#)
- [NVIDIA Quadro SDI Capture](#)

17.1 HP Z440

This section describes how to setup a HP Z440 machine with the different cards provided by Vizrt. The HP Z440 (4U rack units) is a high performance single-CPU workstation with 8 memory slots, multiple storage and PCIe configuration options.

More details about the HP Z440 can be found on HP's website: [HP Z440 Info](#).



HP Z440 with NVIDIA K6000 card, Matrox X.mio2:



17.1.1 HP Z440 PCI/PCIe Slot layout and usage

Slot #	Type	Used for
13	PCIe2 x1	AES Audio card (if the video card has it)
14	PCIe3 x16	Graphic card
15	PCIe2 x4	Unused/Free
16	PCIe3 x8	Video Card (Matrox, DVS or Bluefish)
17	PCIe3 x16	Radial Aerator, if needed, see note below
18	PCI 32/33	Unused/Free

Note: Radial Aerato is recommended for the X.mio2 and X.mio2 Plus boards. However, for video cards that have an onboard fan, such as the X.mio3, DSX LE 4, DVS Atomix or Bluefish Epoch 4K Supernova cards, this is not needed.

17.1.2 Z440 BIOS Settings

- Advanced – Power Options – Fan Idle Mode
Default is two steps below maximum: **
Fan can be set to maximum, if temperatures are high.

17.1.3 Memory expansion

Memory expansions must follow the predefined fill-order and memory-type requirements. There is a table documenting the memory fill order inside the server cabinet. Refer to that table when adding memory modules. Memory configurations with more than 4 memory DIMMs installed, require the [HP Z440 Memory Cooling Solution](#) (AMO kit P/N J2R52AA). This fan can be obtained from Vizrt, or directly from HP.

17.2 HP Z840

This section describes how to setup a HP Z840 machine with the different cards provided by Vizrt. The HP Z840 (5U rack units) is a high performance workstation that can be configured with two CPUs, has 16 memory slots, multiple storage and PCIe configuration options.

More details about the HP Z840 can be found on HP's website: [HP Z840 Info](#) and [HP Z840 Support](#).



IMPORTANT! Before touching any components make sure you use an anti-static wrist strap to prevent electrostatic discharge.

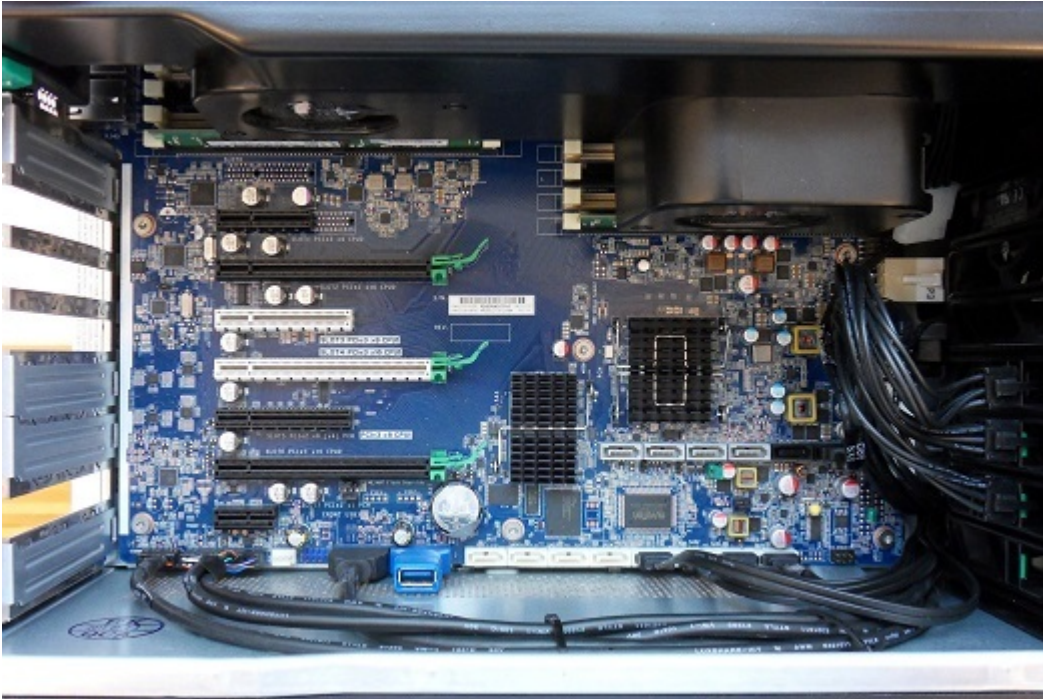

17.2.1 HP Z840 PCI/PCIe Slot layout and usage

Single GPU setups (one graphics device):

Slot #	Type	Used for
16	PCIe3 x4 - CPU0	AES Audio card (if required/used)
17	PCIe3 x16 - CPU0	Graphics card 1
18	PCIe3 x8 - CPU1	free
19	PCIe3 x16 - CPU1	free
20	PCIe3 x8 CPU1	free
21	PCIe3 x16 - CPU0	Video card (Matrox, DVS or Bluefish)
22	PCIe2 x1 - PCH	Radial Aerator (if needed, see note below)

Dual GPU setups (two graphics devices):

Slot #	Type	Used for
16	PCIe3 x4 - CPU0	AES Audio card (if required/used)
17	PCIe3 x16 - CPU0	Graphics card 1
18	PCIe3 x8 - CPU1	free
19	PCIe3 x16 - CPU1	Video card (Matrox, DVS or Bluefish)
20	PCIe3 x8 CPU1	free

Slot #	Type	Used for
21	PCIe3 x16 - CPU0	Graphics card 2
22	PCIe2 x1 - PCH	free

.....
IMPORTANT! A Radial Aerator is recommended for the Matrox X.mio2 video boards. However, the Radial Aerator is not needed for video cards with an onboard fan, such as the Matrox X.mio3, DVS Atomix or Bluefish Epoch 4K Supernova. The Radial Aerator cannot physically be installed with the Xmio.2 Plus board, in which case the BIOS chassis fan speed setting must be set to maximum to achieve sufficient cooling.

17.2.2 Z840 BIOS Settings

- Advanced – Power Options – Fan Idle Mode
 - With one Graphic card: two steps below maximum: **
 - With two Graphic cards: maximum ****
- Advanced – Performance Options:
 - Intel Hyper Threading Technology: Disabled
 - QPI mode: Home Snoop

17.2.3 Memory expansion

Memory expansions must follow the predefined fill-order and memory-type requirements. There is a table documenting the memory fill order inside the server cabinet. Use this table as a reference when adding memory modules.

17.3 HP DL360 Gen9

The HP DL360 Gen9 is a space-saving 1U server. This is a dual-CPU server with 24 DIMM slots, which is configured with Windows Server 2008 R2.

Only single slot [NVIDIA Graphics Cards](#) can be used, either **M2000** or **M4000**.

There are two expansion slots:

- One for the Graphic Card.
- One for a [Matrox X.mio3](#) or DSX LE 4 video card.

The HP DL360 Gen9 with Quadro K4200 and DSXLE3 video I/O:

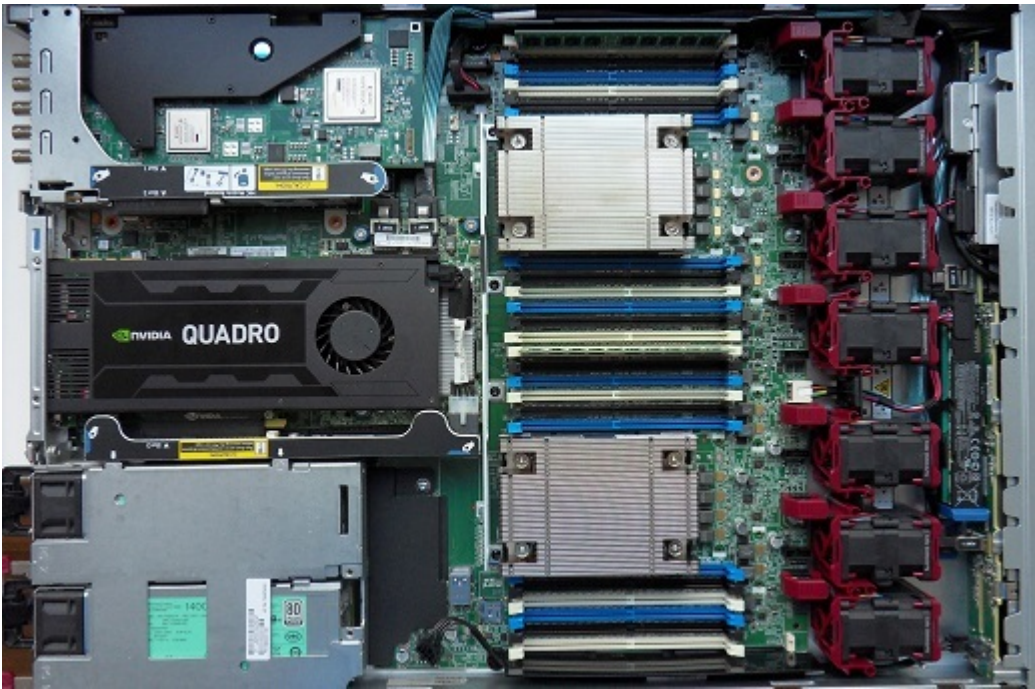

17.3.1 HP DL360 Gen9 BIOS settings

Setting	Value
System Options > Processor Options -> Hyperthreading	Disabled
Performance Options -> Node Interleaving	Enabled
Performance Options -> QPI Snoop Configuration	Home Snoop
Advanced Options -> Video Options -> Add-in Video	Enabled
Advanced Options -> Video Options -> Embedded Video	Disabled
Power Management -> Power Profile	Maximum Performance
Boot Options -> UEFI Optimized Boot:	
For systems running Windows Server 2008 R2	Disabled
For systems running Windows Server 2012 R2	Enabled

17.4 HP DL380 Gen9

The HP DL380 Gen9 is a 2U rack mountable server. This is a dual-CPU server with 24 DIMM slots, which comes configured with Windows Server 2008 R2 or Windows Server 2012 R2.

This server can be configured with up to two dual slot [NVIDIA Graphics Cards](#). Dual GPU configurations require the system to be configured with Windows Server 2012 R2.

17.4.1 HP DL380 Gen9 PCI/PCIe Slot layout and usage

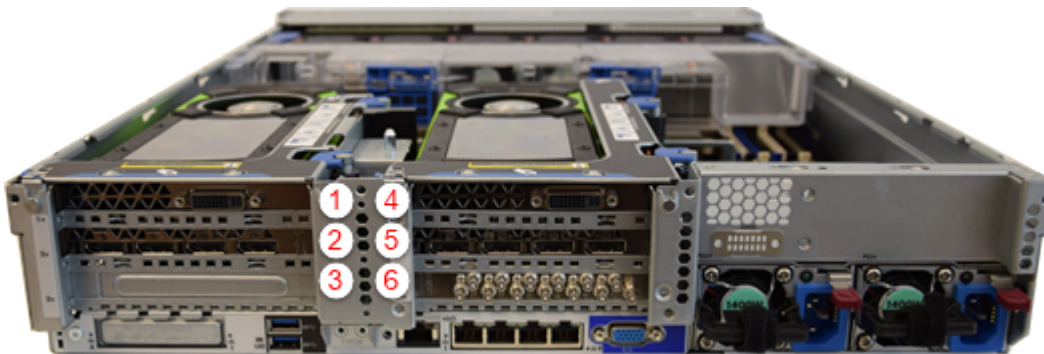

Slot #	Used for
1	Empty
2	Graphics card 1
3	Optional AES Audio for Matrox X.mio3
4	Empty
5	Graphics card 2
6	Matrox X.mio3 IP , Matrox X.mio3 , or Matrox DSX LE4 video card

Note: Other video boards are not tested with this server.

17.4.2 HP DL380 Gen 9 BIOS settings

Setting	Value
System Options > Processor Options -> Hyperthreading	Disabled
Performance Options -> Node Interleaving	Enabled
Performance Options -> QPI Snoop Configuration	Home Snoop
Advanced Options -> Video Options -> Add-in Video	Enabled
Advanced Options -> Video Options -> Embedded Video	Disabled
Power Management -> Power Profile	Maximum Performance

Setting	Value
Boot Options -> UEFI Optimized Boot:	
For systems running Windows Server 2008R2	Disabled
For systems running Windows Server 2012R2	Enabled

17.5 Dell R7910 (2U) Rack Server

The Dell R7910 Rack Workstation is a high-performance 2U Rack server. It is a dual-CPU server with 24 DIMMS memory slots, and can be configured with high-end Quadro graphics, [Matrox](#) Video I/O, and AES Audio.



17.5.1 Dell R7910 Rack Workstation slots

The server have 4 slots for expansion cards. One slot is not connected to the motherboard, as indicated with no-Slot in the picture below:



17.5.2 To setup a single channel graphics with Video and AES Audio

- Graphic card in PCIe3 x16 above the power supply.
- Matrox card in PCIe3 x8.
- AES Audio above the Matrox card.

17.5.3 To setup Dual Channel with two K4200 graphics cards

- Both K4200 in the PCIe3 x16 slots.
- Matrox card in the PCIe3 x8 slot.
- AES Audio in the “no Slot”, as this does not need connection to the motherboard.

.....
Note: Bluefish and DVS video boards have not been tested with this server.
.....

17.5.4 BIOS settings

BIOS Setting	Value
Memory settings	Snoop Mode – Home Snoop
Processor settings	Logical Processor – disabled
SATA Settings	Embedded SATA – Raid Mode
Boot Settings	Boot Mode: BIOS
Integrated Devices	Embedded Video Controller - disabled

17.6 Supermicro SuperServer 7048 GR-TR

The dual-processor SuperServer 7048 GR-TR have excellent expansion capabilities and can be configured with up to four graphic cards. The chassis can be configured with tower top cover and feet as a desktop server, or as a 4U rack mountable chassis.



This section covers the following details:

- [GPU Installation](#)
- [BIOS Settings](#)

17.6.1 GPU Installation

The NVIDIA graphic cards must be installed with the first one at the bottom, furthest away from the CPU:

Slot	Card
CPU1 Slot2 PCI-E 3.0 x16	Graphic Card 1
CPU1 Slot4 PCI-E 3.0 x16	Graphic Card 2
CPU2 Slot6 PCI-E 3.0 x16	Graphic Card 3
CPU2 Slot8 PCI-E 3.0 x16	Graphic Card 4
CPU1 Slot10 PCI-E 3.0 x8 (in x16)	Matrox card

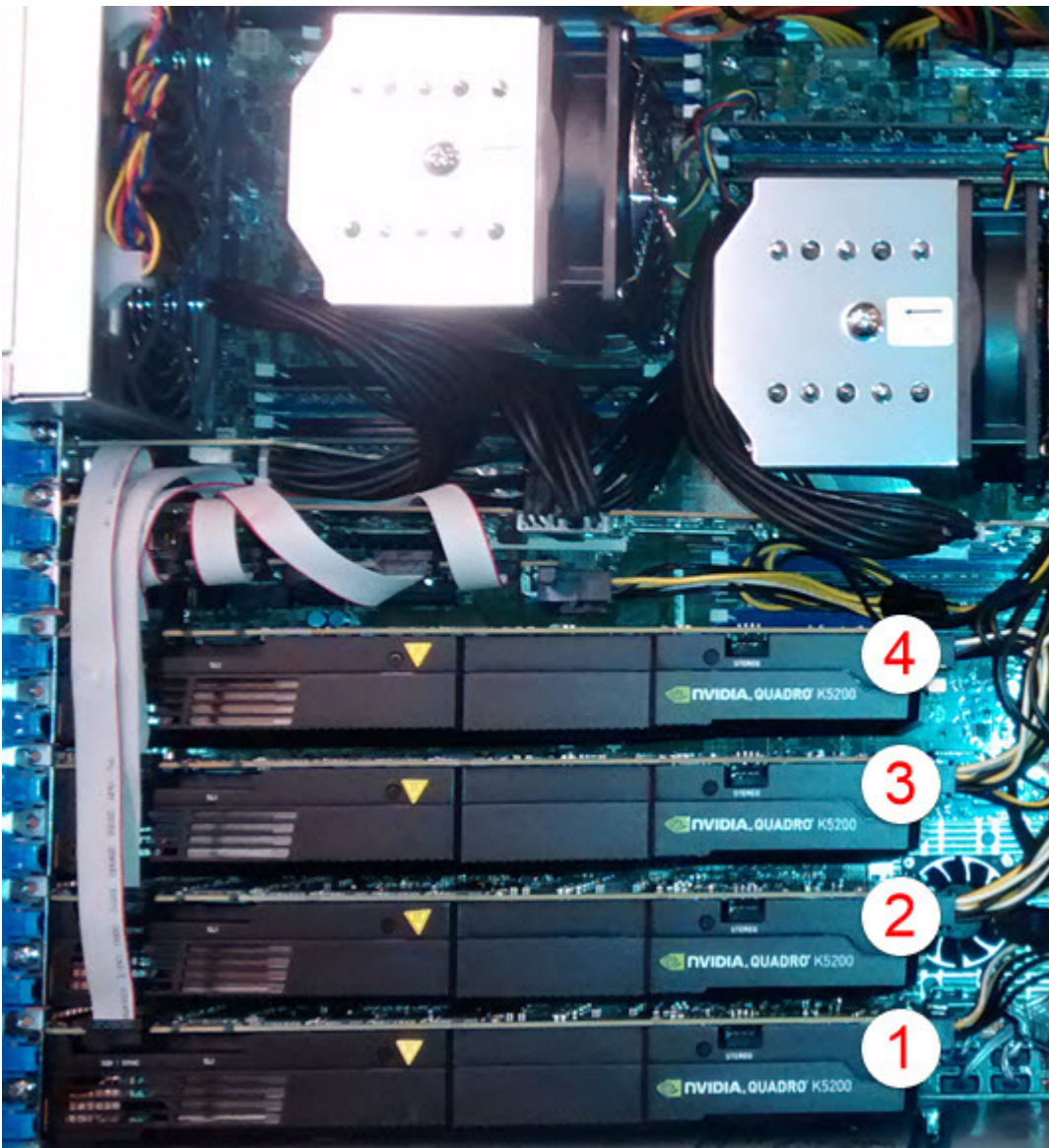

Also, make sure that the onboard GPU is disabled by setting the **JPG1** jumper to pins 2 and 3:

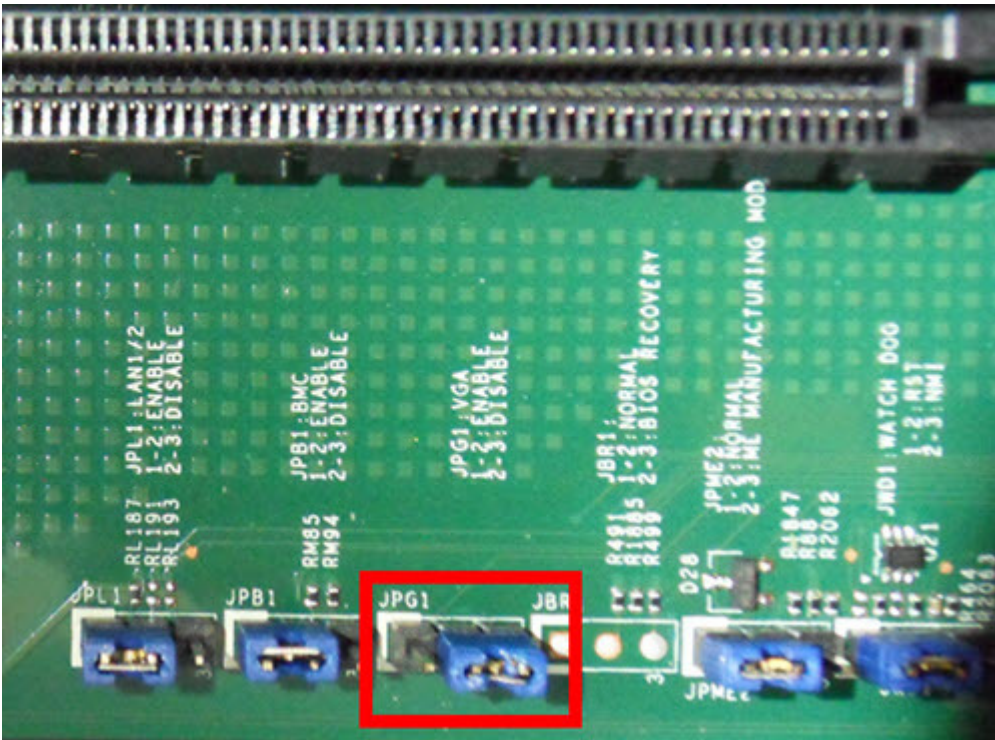

17.6.2 BIOS Settings

Setting	Value
Advanced -> CPU Configuration Hyper-Threading (All)	Disabled
Advanced -> Chipset Configuration -> North Bridge -> QPI Configuration -> QPI General Configuration -> Early Snoop	Disabled
Advanced -> CPU Configuration -> Advanced Power Management Configuration:	
Power Technology	Disabled
Energy Performance Tuning	Disabled
Energy BIAS Setting	Performance
Energy Efficient Turbo	Disabled

17.7 HP ZBook 15/17 G3 Mobile workstation

The HP ZBook is a mobile workstation available as 15 and 17 inch models with the powerful Intel Core i7 CPU, from 16 to 64 gigabytes of RAM, and a full HD resolution display.



The 15-inch model can be used for design and control applications, as it features a full HD display and an NVIDIA Quadro M1000M or NVIDIA M2000M graphics card, depending on the configuration.

The 17-inch model can, in addition to design and control applications, also be used for SDI productions. It is available with either an NVIDIA Quadro M4000M or NVIDIA Quadro M5000M video card. For SDI productions, the HP ZBook must be extended with an [AJA Io 4K](#) external video board and require a Thunderbolt 3 to Thunderbolt 2 adapter.

Both models come with the Microsoft Windows 7 Professional 64 bit operating system.

17.7.1 HP ZBook BIOS settings

Setting	Value
Advanced -> Built-In Device	Discrete Graphics
Options -> Graphics	

This BIOS setting is required to make sure Viz Engine runs only on the NVIDIA graphic card, and not on the built-in Intel HD graphic card.

See Also

- [AJA Io 4K](#)

17.8 Deprecated servers

The following servers are deprecated. The information in this section is for historical reference only and will not be updated for new hardware.

- [HP ML350p Gen8](#)
- [HP Z420](#)
- [HP Z800](#)

- [HP Z820](#)
- [HP DL370](#)
- [HP xw8200](#)
- [HP xw8400](#)
- [HP xw8600](#)

17.8.1 HP ML350p Gen8





This section describes how to setup a HP ML350p Gen8 machine with the different cards provided by Vizrt:

- [To Setup an HP ML350p Gen8 with a DVS board](#)
 - [PCI-X, PCI slots, HP ML350p Gen8](#)
- [To Setup an HP ML350p Gen8 with a Matrox board](#)
 - [PCI-X, PCI slots, HP ML350p Gen8](#)





To Setup an HP ML350p Gen8 with a DVS board

PCI-X, PCI slots, HP ML350p Gen8

Slot Processor 1

1		PCIe3 x16 (8, 4, 2, 1)
2		PCIe3 x8 (4, 1)
3		PCIe3 x16 (16, 8, 4, 1)
4		PCIe3 x8 (4, 1)

Processor 2

5		PCIe2 x8 (4, 1)
6		PCIe3 x16 (16, 8, 4, 1)
7		PCIe3 x8 (4, 1)
8		PCIe3 x16 (16, 8, 4, 1)
9		PCIe3 x8 (4, 1)

.....
IMPORTANT! Before touching any components make sure you use an anti-static wrist strap to prevent electrostatic discharge.

1. Disconnect the power and all other peripherals.
2. Install the video board in slot 1.
3. Install the graphic card in slot 6.

.....
Note: Make sure that the cable connections are correctly mounted and that they stay clear of any supplemental aerators or the aerator of the graphics device.





4. Tidy up all cables and close the computer case.

.....
Note: Placement of cards are the same for both DVS Atomix HDMI (see [Digital Video Systems](#)) and [DVS Centaurus II](#)
.....





To Setup an HP ML350p Gen8 with a Matrox board

PCI-X, PCI slots, HP ML350p Gen8

Slot Processor 1

1		PCIe3 x16 (8, 4, 2, 1)
2		PCIe3 x8 (4, 1)
3		PCIe3 x16 (16, 8, 4, 1)
4		PCIe3 x8 (4, 1)

Processor 2

5		PCIe2 x8 (4, 1)
6		PCIe3 x16 (16, 8, 4, 1)
7		PCIe3 x8 (4, 1)
8		PCIe3 x16 (16, 8, 4, 1)
9		PCIe3 x8 (4, 1)

.....
IMPORTANT! Before touching any components make sure you use an anti-static wrist strap to prevent electrostatic discharge.
.....

1. Disconnect the power and all other peripherals.
2. Insert the video board in slot 1.
3. Insert graphic card 1 in slot 6.
4. Insert graphic card 2 in slot 8.
5. Insert the Matrox audio board in slot 3.
6. Insert the radial-aerator in slot 2.

.....
IMPORTANT! A radial-aerator is mandatory as the video board reaches high temperatures during operation.
.....

7. Insert the slot panel (x2) for the X.mio2/44 board in slot 4. Connect it to the X.mio2 board.
8. Tidy up all cables and close the computer's casing.
9. Start the machine.

Once the machine is powered up, check that the Matrox X.mio board has been correctly installed. Check that the blue OB-light on the (top) backside of the slot panel is set to ON. If the LED is ON the board is correctly supplied with power.

17.8.2 HP Z420

This section describes how to setup a HP Z420 machine with the different cards provided by Vizrt:

- [To Setup an HP Z420 with a BlueFish444 Epoch board](#)
 - [PCI-X, PCI and AGP slots, HP Z420](#)
- [To Setup an HP Z420 with a DVS board](#)
 - [PCI-X, PCI and AGP slots, HP Z420](#)
- [Note: Placement of cards are the same for both DVS Atomix HDMI \(see Digital Video Systems\) and DVS Centaurus II](#)
- [To Setup an HP Z420 with a Matrox board](#)
 - [PCI and PCIe slots, HP Z420](#)
- [To Setup an HP Z420 with a capture card](#)
 - [PCI and PCIe slots, HP Z420](#)
-

To Setup an HP Z420 with a BlueFish444 Epoch board

PCI-X, PCI and AGP slots, HP Z420

.....
IMPORTANT! Before touching any components make sure you use an anti-static wrist strap to prevent electrostatic discharge.
.....

1. Disconnect the power and all other peripherals.
2. Insert the graphics card in slot 20.
3. Insert the BlueFish444 video board in slot 22.

.....
Note: If you are using the BNC adapter with the Epoch|2K Horizon board it can be placed directly adjacent the video board on either side.
.....

4. Tidy up all cables and close the computer's casing.

To Setup an HP Z420 with a DVS board

PCI-X, PCI and AGP slots, HP Z420

.....
IMPORTANT! Before touching any components make sure you use an anti-static wrist strap to prevent electrostatic discharge.
.....

1. Disconnect the power and all other peripherals.
2. Install the video board in slot 22.
3. Install the graphics card in slot 20.
4. Install the video board two extension boards:
 - SDI/RS-422 panel in slot 19

- BNC panel in slot 23

.....
Note: Make sure that the cable connections are correctly mounted and that they stay clear of any supplemental aerators or the aerator of the graphics device.

5. Tidy up all cables and close the computer's casing.
-

Note: Placement of cards are the same for both DVS Atomix HDMI (see Digital Video Systems) and DVS Centaurus II

.....

To Setup an HP Z420 with a Matrox board

PCI and PCIe slots, HP Z420

.....
IMPORTANT! Before touching any components make sure you use an anti-static wrist strap to prevent electrostatic discharge.

1. Disconnect the power and all other peripherals.
2. Insert the graphics card in slot 20.
3. Insert the Matrox video board in slot 22.
4. Insert the radial-aerator in slot 23.

.....
IMPORTANT! A radial-aerator is mandatory as the video board reaches high temperatures during operation.

5. *Optional:* Insert the [Matrox](#) video board in slot 19.
6. *Optional:* Insert the extra slot panel for the X.mio2/44 board in any of the vacant slots, and connect it to the X.mio2 board.
7. Tidy up all cables and close the computer's casing.
8. Start the machine. The Matrox X.mio2+ gets very hot in the HP Z420. Make sure that the HP Z420 Fan and Front Card Guide Kit is installed, and set the fan speed to the highest value in BIOS (Power -> Thermal).

Once the machine is powered up, check that the Matrox X.mio board has been correctly installed. Check that the blue OB-light on the (top) backside of the slot panel is set to ON. If the LED is ON the board is correctly supplied with power.

To Setup an HP Z420 with a capture card

PCI and PCIe slots, HP Z420

.....
IMPORTANT! Before touching any components make sure you use an anti-static wrist strap to prevent electrostatic discharge.
.....

1. Disconnect the power and all other peripherals.
2. Insert the graphics card in slot 20.
3. Insert the NVIDIA capture card in slot 22.
4. Tidy up all cables and close the computer's casing.

17.8.3 HP Z800

This section describes how to setup a HP Z800 machine with the different cards provided by Vizrt:

To Setup an HP Z800 with a BlueFish444 Epoch board

PCI-X, PCI and AGP slots, HP Z800

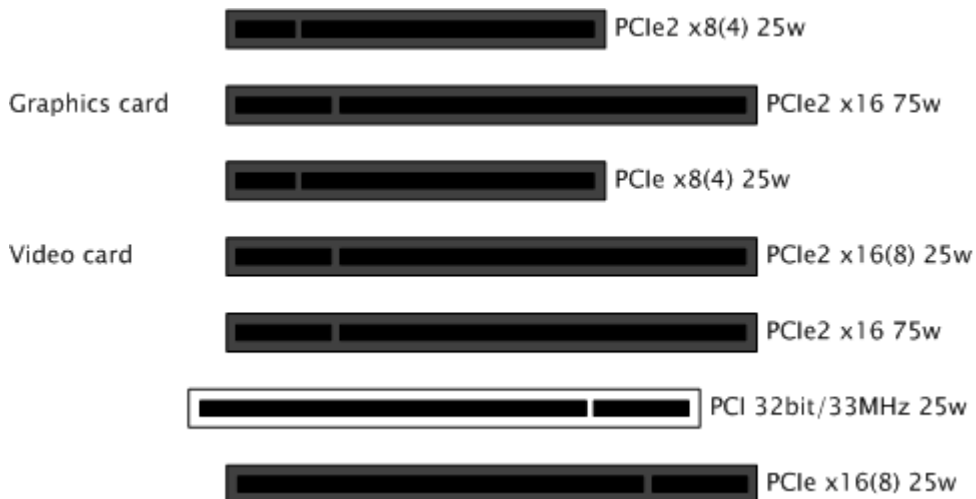

.....
IMPORTANT! Before touching any components make sure you use an anti-static wrist strap to prevent electrostatic discharge.
.....

1. Disconnect the power and all other peripherals.
2. Insert the graphics card in the PCIe slot number 2 from the top.
3. Insert the BlueFish444 video board in the PCIe slot number 4 from the top.

.....
Note: If you are using the BNC adaptor with the Epoch|2K Horizon board it can be placed directly adjacent the video board on either side.
.....

To Setup an HP Z800 with a DVS board

PCI-X, PCI and AGP slots, HP Z800



.....
IMPORTANT! Before touching any components make sure you use an anti-static wrist strap to prevent electrostatic discharge.
.....

1. Disconnect the power and all other peripherals.
2. Install the video board in slot number 5 from the top.
3. Install the graphics card in slot number 2 from the top.
4. Install the separate SDI/RS-422 panel in slot number 1 from the top.
 - Make sure that the cable connections are properly mounted and that it stays clear of any supplemental aerators or the aerator of the graphics device.
5. Tidy up all cables and close the computer's casing.

.....
Note: Placement of cards are the same for both [Digital Video Systems](#) and [DVS Centaurus II](#)
.....

To Setup an HP Z800 with a Matrox board

PCI and PCIe slots, HP Z800

Audio card		PCIe2 x8(4) 25w
Graphics card		PCIe2 x16 75w
		PCIe x8(4) 25w
		PCIe2 x16(8) 25w
Video card		PCIe2 x16 75w
		PCI 32bit/33MHz 25w
Radial aerator		PCIe x16(8) 25w

.....
IMPORTANT! Before touching any components make sure you use an anti-static wrist strap to prevent electrostatic discharge.
.....

1. Disconnect the power and all other peripherals.
2. Insert the graphics card in PCIe2 slot number 2 from the top.
3. Insert the Matrox video board into the PCIe2 slot number 5 from the top.
4. Insert the radial-aerator into the PCIe slot number 7 from the top.

.....
IMPORTANT! The Matrox video boards can reach very high temperatures when in operation. If a Xmio.2 board is used, a radial-aerator must be installed. If a Xmio.2 Plus board is used a radial-aerator can not, physically, be installed. In this case the chassis fan speed (in BIOS) must be set to maximum to achieve sufficient cooling.
.....

5. *Optional:* Insert the [Matrox](#) video board into the PCIe2 slot number 1 from the top.
6. *Optional:* Insert the extra slot panel for the X.mio2/44 board in any of the vacant slots, and connect it to the X.mio2 board.
7. Tidy up all cables and close the computer's casing.
Once the machine is powered up you may verify that the Matrox X.mio board has been correctly installed by looking for the blue OB-light on the (top) backside of the slot panel. A lit light indicates that the board is correctly supplied with power.

To Setup an HP Z800 with two graphics cards

PCI and PCIe slots, HP Z800

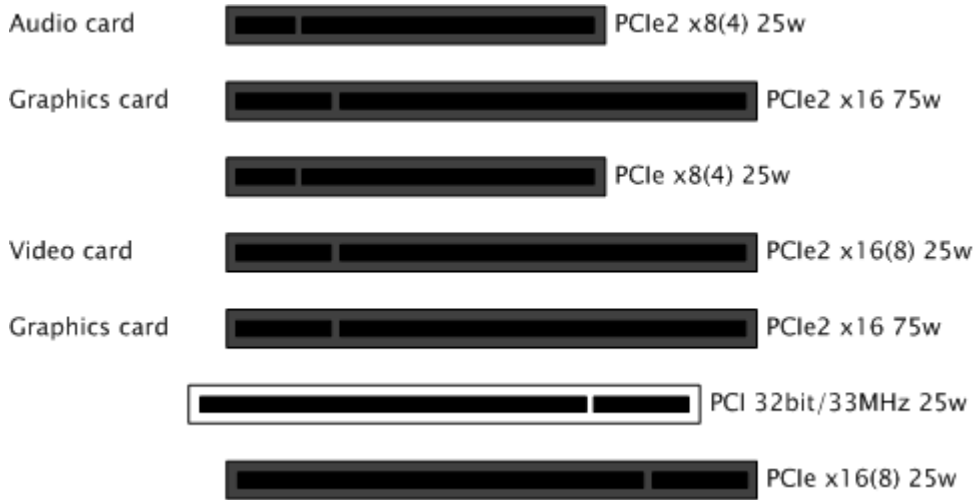

.....
IMPORTANT! Before touching any components make sure you use an anti-static wrist strap to prevent electrostatic discharge.
.....

1. Disconnect the power and all other peripherals.
2. Insert the weaker graphics card in PCIe2 slot number 2 from the top.
3. Insert the stronger graphics card in PCIe2 slot number 5 from the top.
4. Insert the Matrox video board in the PCIe2 slot number 4 from the top.
5. Insert the radial-aerator into the PCIe slot number 3 from the top.
 - A radial-aerator is mandatory as the video board reaches high temperatures during operation.
6. *Optional:* Insert the [Matrox](#) video board into the PCIe2 slot number 1 from the top.
7. Tidy up all cables and close the computer's casing.
8. Connect the computer's monitor to the graphics card in slot 2 from the top.
9. Start the machine and in the BIOS (Advanced: Thermal – Full Fan speed) set all fans to run at full speed.
10. Boot and log on to the machine.
11. Install NVIDIA and Matrox drivers.
12. Open the NVIDIA Control Panel, and click on System Information in the bottom left corner and check that both graphics cards are installed and run at PCIe x16 speed.
13. Open Matrox X.info from the system tray and check that the video board runs at PCIe x8 speed. Once the machine is powered up you may verify that the Matrox X.mio board has been correctly installed by looking for the blue OB-light on the (top) backside of the slot panel. A lit light indicates that the board is correctly supplied with power.

IMPORTANT! Before touching any components make sure you use an anti-static wrist strap to prevent electrostatic discharge.

1. Disconnect the power and all other peripherals.
2. Insert the graphics card in slot 17.
3. Insert the Matrox video board in slot 21.
4. Insert the radial-aerator in slot 22.

IMPORTANT! The Matrox video boards can reach very high temperatures when in operation. If a Xmio.2 board is used, a radial-aerator must be installed. If a Xmio.2 Plus board is used a radial-aerator can not, physically, be installed. In this case the chassis fan speed (in BIOS) must be set to maximum to achieve sufficient cooling.

5. *Optional:* Insert the in slot 16.
6. *Optional:* Insert the extra slot panel for the X.mio2/44 board in any of the vacant slots, and connect it to the X.mio2 board.
7. Tidy up all cables and close the computer's casing.

Once the machine is powered up, check that the Matrox X.mio board has been correctly installed. Check that the blue OB-light on the (top) backside of the slot panel is set to ON. If the LED is ON the board is correctly supplied with power.

To Setup an HP Z820 with two graphics cards

PCI and PCIe slots, HP Z820

Audio card	16		PCIe3 x8(4)
Graphics card	17		PCIe3 x16
	18		PCIe3 x16(8)
	19		PCIe3 x16
	20		PCIe2 x8(4)
Video card	21		PCIe3 x16
Radial aerator	22		PCI 32bit/33MHz

IMPORTANT! Before touching any components make sure you use an anti-static wrist strap to prevent electrostatic discharge.

1. Disconnect the power and all other peripherals.
2. Insert the weaker graphics card in slot 17.
3. Insert the stronger graphics card in slot 19.
4. Insert the Matrox video board in slot 21.
5. Insert the radial-aerator in slot 22.

IMPORTANT! A radial-aerator is mandatory as the video board reaches high temperatures during operation.









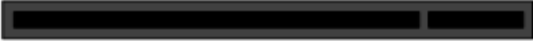

6. *Optional:* Insert the [Matrox](#) video board in slot 16.
7. Tidy up all cables and close the computer's casing.
8. Connect the computer's monitor to the graphics card in slot 17.
9. Start the machine.
10. In the BIOS (Advanced: Thermal – Full Fan speed) set all fans to run at full speed.
11. Boot and log on to the machine.
12. Install the NVIDIA and Matrox drivers.
13. Open the NVIDIA Control Panel, and click on System Information in the bottom left corner and check that both graphics cards are installed and run at PCIe x16 speed.
14. Open Matrox X.info from the system tray and check that the video board runs at PCIe x8 speed. Once the machine is powered up, check that the Matrox X.mio board has been correctly installed. Check that the blue OB-light on the (top) backside of the slot panel is set to ON. If the LED is ON the board is correctly supplied with power.

17.8.5 HP DL370

This section describes how to setup a HP DL370 G6 machine with the different cards provided by Vizrt.

To Setup an HP DL370 G6 with one graphics card

PCI and PCIe slots, HP DL370 G6

		PCIe2 x8 25w
		PCIe2 x8(4) 25w
Graphics card		PCIe2 x16 75w
		PCIe2 x8(4) 25w
		PCIe2 x16(8) 25w
Audio card		PCIe2 x8(4) 25w
		PCIe2 x8(4) 25w
Video card		PCIe2 x16 75w
		PCIe2 x8(4) 25w
		PCIe x8(4) 25w

IMPORTANT! Before touching any components make sure you use an anti-static wrist strap to prevent electrostatic discharge.

1. Disconnect the power and all other peripherals.
2. Insert the graphics card in PCIe2 slot number 8 from the left.
3. Insert the video board (i.e. Matrox X.mio2) into the PCIe2 slot number 3 from the left.
4. If you have a Matrox board, insert the radial-aerator into the PCIe slot number 2 from the left.
 - A radial-aerator is mandatory as the video board reaches high temperatures during operation.
5. *Optional:* Insert the [Matrox](#) into the PCIe2 slot number 5 from the left.
6. *Optional:* Insert the extra slot panel for the X.mio2/44 board in any of the vacant slots, and connect it to the X.mio2 board.
7. Tidy up all cables and close the computer's casing.

.....
Note: Matrox DSX.LE cannot be mounted in the DL370 G6

Once the machine is powered up you may verify that the Matrox X.mio board has been correctly installed by looking for the blue OB-light on the (top) backside of the slot panel. A lit light indicates that the board is correctly supplied with power.

To Setup an HP DL370 G6 with two graphics cards

PCI and PCIe slots, HP DL370 G6

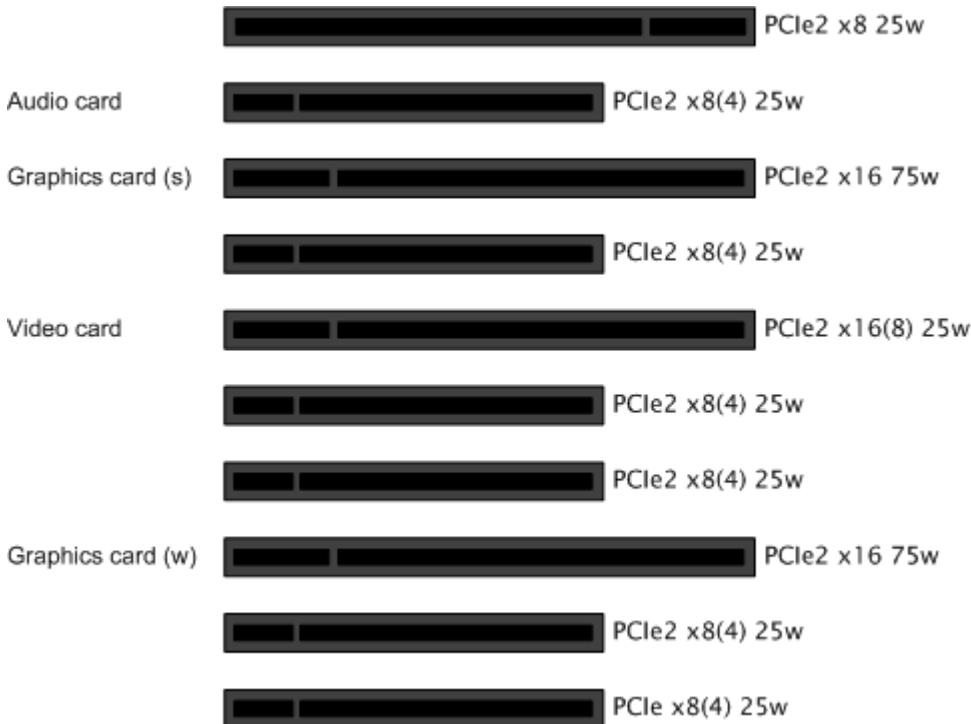

.....
IMPORTANT! Before touching any components make sure you use an anti-static wrist strap to prevent electrostatic discharge.

1. Disconnect the power and all other peripherals.
2. Insert the weaker graphics card in PCIe2 slot number 3 from the left.
3. Insert the stronger graphics card in PCIe2 slot number 8 from the left.
4. Insert the video board (i.e. Matrox X.mio2) in the PCIe2 slot number 6 from the left.

5. If you have a Matrox board, insert the radial-aerator into the PCIe slot number 5 from the left.
 - A radial-aerator is mandatory as the video board reaches high temperatures during operation.
6. *Optional:* Insert the [Matrox](#) video board into the PCIe2 slot number 9 from the left.
7. Tidy up all cables and close the computer's casing.
8. Connect the computer's monitor to the graphics card in slot 3 from the left.
9. Start the machine and in the BIOS (Advanced: Thermal – Full Fan speed) set all fans to run at full speed.
10. Boot and log on to the machine.
11. Install NVIDIA and Video board drivers.
12. Open the NVIDIA Control Panel, and click on System Information in the bottom left corner and check that both graphics cards are installed and run at PCIe x16 speed.
13. If you installed a Matrox board, open Matrox X.info from the system tray and check that the video board runs at PCIe x8 speed.

.....
Note: Matrox DSX.LE cannot be mounted in the DL370 G6

Once the machine is powered up you may verify that the Matrox X.mio board has been correctly installed by looking for the blue OB-light on the (top) backside of the slot panel. A lit light indicates that the board is correctly supplied with power.

To Setup an HP DL370 G6 with a capture card

PCI and PCIe slots, HP DL370 G6

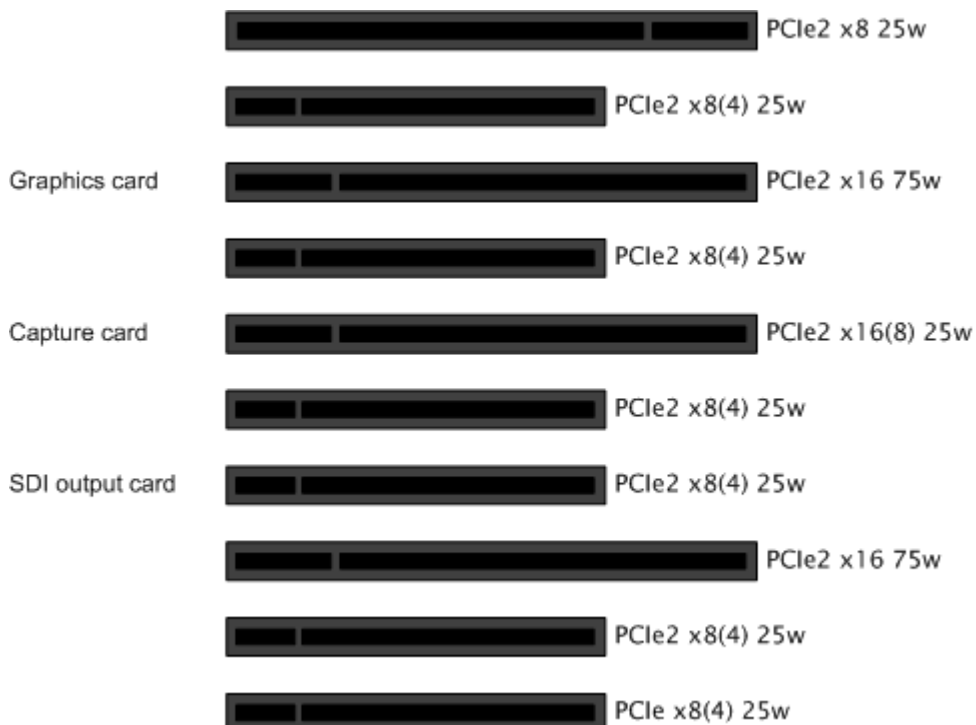

.....
IMPORTANT! Before touching any components make sure you use an anti-static wrist strap to prevent electrostatic discharge.

1. Disconnect the power and all other peripherals.
2. Insert the graphics card in PCIe2 slot number 8 from the left.
3. Insert the capture card in PCIe2 slot number 6 from the left.
4. Insert the SDI output board in the PCIe2 slot number 4 from the left.
5. Tidy up all cables and close the computer's casing.

To Configure the BIOS

1. Start the machine and open the machine's **BIOS** system
2. Go to **System Options > Processor Options**
3. Deactivate **Hyperthreading**
 - The Matrox X.mio2 board will not function if this setting is enabled
4. Deactivate Intel **Virtualization Technology**
5. Deactivate Intel **VT-d2**

.....
Note: Steps 2 and 3 are only needed for VMWare setups

6. Go to **Power Management Options > Advanced Power Management Options > PCI Express Generation 2.0 Support**
7. Activate **Force PCI-E Generation 2**
8. **Save** and **exit** the BIOS

17.8.6 HP xw8200

This section describes how to setup a HP xw8400 machine with the different cards provided by Vizrt.

To Setup an HP xw8200

PCI, PCIe and PCI-X slots, HP xw8200

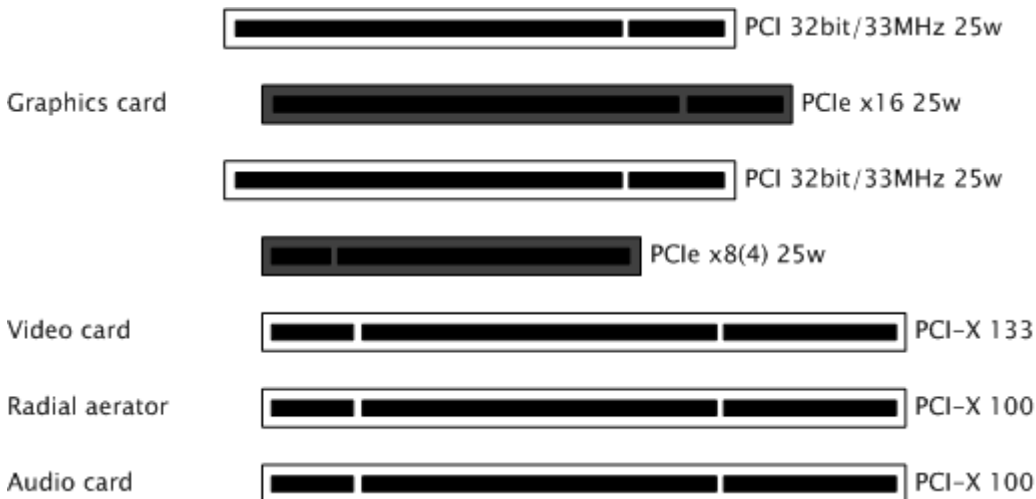

.....
IMPORTANT! Before touching any components make sure you use an anti-static wrist strap to prevent electrostatic discharge.

1. Disconnect the power and all other peripherals.
2. Insert the graphics card in the PCIe slot number 2 from the top.
3. Insert the Matrox video board into the PCI-X slot number 4 from the top.
4. Insert a powerful radial-aerator into the PCI-X slot number 6 from the top.
5. Optional: Insert the [Matrox](#) video board into the PCI slot number 7 from the top.

.....
Note: A radial-aerator is mandatory as the video board reaches high temperatures during operation.

Once the machine is powered up you may verify that the Matrox X.mio board has been correctly installed by looking for the blue OB-light on the (top) backside of the slot panel. A lit light indicates that the board is correctly supplied with power.

17.8.7 HP xw8400

This section describes how to setup a HP xw8400 machine with the different cards provided by Vizrt.

To Setup an HP xw8400

SATA plug, HP xw8400



.....
IMPORTANT! Before touching any components make sure you use an anti-static wrist strap to prevent electrostatic discharge.

1. Disconnect the power and all other peripherals.
2. Before mounting the video board, the SATA connector originally connected to the SATA port 0 needs to be reconnected to SATA port 1 to make room for the video board.



.....
Note: For an HP xw8400, the X.mio24/6000 video boardInsert the Matrox video board into the PCI-X slot number 6d requires a 64-bit PCI-X slot operating at a minimum of 100 MHz.

3. Insert the graphics card in the PCIe slot number 2 from the top.
4. from the top.
5. Insert a powerful radial-aerator into the PCI-X slot number 7 from the top.
6. *Optional:* Insert the [Matrox](#) video board into the PCI-X slot number 5 from the top.

.....
Note: A radial-aerator is mandatory as the video board reaches high temperatures during operation.

Once the machine is powered up you may verify that the Matrox X.mio board has been correctly installed by looking for the blue OB-light on the (top) backside of the slot panel. A lit light indicates that the board is correctly supplied with power.

17.8.8 HP xw8600

This section describes how to setup a HP xw8600 machine with the different cards provided by Vizrt.

To Setup an HP xw8600 with a DVS Centaurus board

PCI-X, PCI and AGP slots, HP xw8600

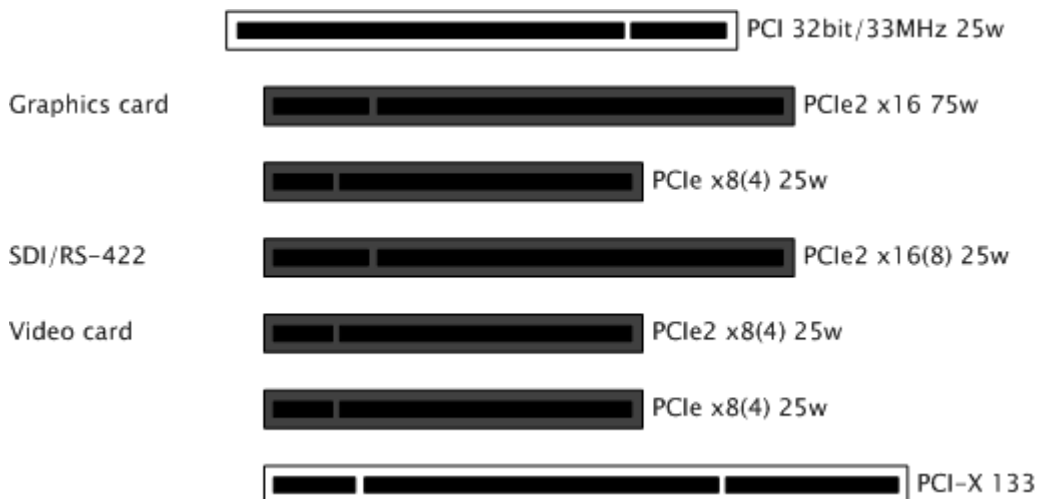

.....
IMPORTANT! Before touching any components make sure you use an anti-static wrist strap to prevent electrostatic discharge.

1. Disconnect the power and all other peripherals.
2. Install the graphics card in slot number 2 from the top.
3. Install the video board in slot number 4 from the top.
4. Install the separate SDI/RS-422 panel in slot number 1 from the top.
 - Make sure that the cable connections are properly mounted and that it stays clear of any supplemental aerators or the aerator of the graphics device.

To Setup an HP xw8600 with a X.mio2/X.mio2plus Matrox board

PCI, PCIe and PCI-X slots, HP xw8600

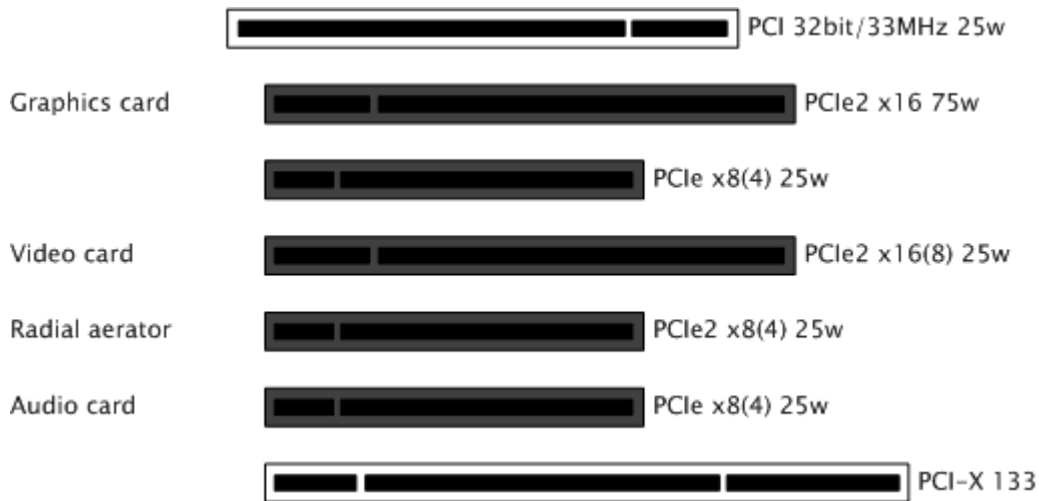

.....
IMPORTANT! Before touching any components make sure you use an anti-static wrist strap to prevent electrostatic discharge.
.....

1. Disconnect the power and all other peripherals.
2. Insert the graphics card in the PCIe slot number 2 from the top.
3. Insert the [Matrox](#) video board in the PCIe slot number 4 from the top.
4. Insert a powerful radial-aerator in the PCIe slot number 5 from the top.
5. *Optional:* Insert the [Matrox](#) video board in the PCI-X slot number 6 from the top.
6. *Optional:* Insert the extra slot panel for the X.mio2/44 board in any of the vacant slots, and connect it to the X.mio2 board.

.....
Note: A radial-aerator is mandatory as the video board reaches high temperatures during operation.
.....

To Setup an HP xw8600 with a X.mio (first gen) Matrox board

PCI, PCIe and PCI-X slots, HP xw8600

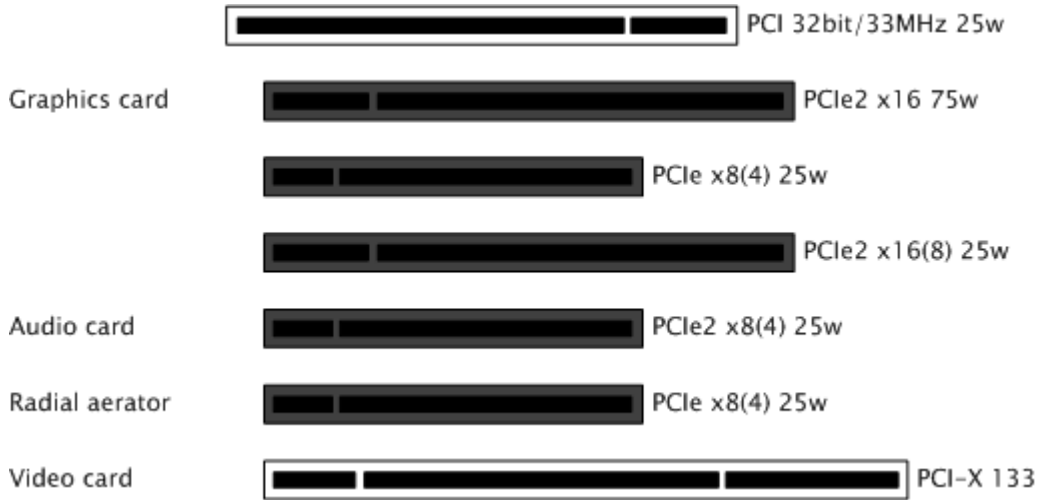

.....
IMPORTANT! Before touching any components make sure you use an anti-static wrist strap to prevent electrostatic discharge.
.....

1. Disconnect the power and all other peripherals.
2. Insert the graphics card in the PCIe slot number 2 from the top.
3. Insert the [Matrox](#) video board into the PCIe slot number 7 from the top.
4. Insert a powerful radial-aerator into the PCIe slot number 6 from the top.
5. Optional: Insert the [Matrox](#) video board into the PCI-X slot number 5 from the top.

.....
Note: A radial-aerator is mandatory as the video board reaches high temperatures during operation.
.....

Once the machine is powered up you may verify that the Matrox X.mio board has been correctly installed by looking for the blue OB-light on the (top) backside of the slot panel. A lit light indicates that the board is correctly supplied with power.

17.9 Handling and installing cards

Static electricity from your body can damage your cards or your computer. Although you may not notice it, static electricity is generated every time you move. It's often too small to cause a spark, but it can still cause damage to sensitive electronic components or at least reduce their lifespan.

To avoid damage, please observe the following precautions:

- Do not remove cards from their anti-static bags until you're ready to install them. Before removing the cards, place the packages within easy reach of the area where you intend to perform the installation.

- You should avoid touching the chips and other components on the circuit boards. Try to handle the cards by their edges.
- Try to work in an area where the relative humidity is at least 50%.
- Do not wear wool or synthetic clothing. These fabrics tend to generate more static electricity than cotton, which is best for this kind of work.
- Turn off the power switches on your computer and its connected components.
Once you've opened your computer, drain static electricity from your body by touching a bare metal surface on your computer chassis before you install or remove any parts of your system. If you have a grounding wrist strap, use it while handling and installing any components in your computer.

18 Legacy Cards

This section contains an overview of legacy and discontinued hardware. Vizrt does not support the hardware described in this chapter. Refer to this section *only* if you are configuring an older version of Viz Engine, or for maintenance purposes.

Caution: Vizrt does not perform any system tests using the hardware in this chapter. Using newer versions than listed of Viz Engine, Viz Artist, operating system or drivers, may cause unexpected behavior or system failure.

This section contains information on the following topics:

- [NVIDIA Legacy Cards](#)
- [BlueFish444 SD Lite Pro Express](#)
- [BlueFish444 Iridium|SD](#)
- [BlueFish444 Epoch 2K Horizon](#)
- [Digital Voodoo D1 Desktop](#)
- [Digital Voodoo DeepBlue LT](#)
- [Digital Voodoo Red Devil V3](#)
- [DVS Centaurus II](#)
- [Pinnacle Targa 3200](#)
- [LPT Controller for a Viz License Dongle](#)

18.1 NVIDIA Legacy Cards

This section details all legacy NVIDIA cards:

- [NVIDIA Quadro 6000](#)
- [NVIDIA Quadro 5000](#)
- [NVIDIA Quadro 4000](#)
- [NVIDIA Quadro 2000](#)
- [NVIDIA Quadro FX 1400](#)
- [NVIDIA Quadro FX 1500](#)
- [NVIDIA Quadro FX 1700](#)
- [NVIDIA Quadro FX 1800](#)
- [NVIDIA Quadro FX 3400](#)
- [NVIDIA Quadro FX 3450](#)
- [NVIDIA Quadro FX 3500](#)
- [NVIDIA Quadro FX 3700](#)
- [NVIDIA Quadro FX 3800](#)
- [NVIDIA Quadro FX 4400](#)
- [NVIDIA Quadro FX 4500](#)
- [NVIDIA Quadro FX 4600](#)
- [NVIDIA Quadro FX 4800](#)
- [NVIDIA Quadro FX 5500](#)
- [NVIDIA Quadro FX 5600](#)

- [NVIDIA Quadro FX 5800](#)
- [NVIDIA Quadro K600](#)

18.1.1 NVIDIA Quadro 6000

Windows XP / Windows 7 (64bit)

Viz Artist/Engine Version	Driver
3.5.4	311.50
3.5.2 - 3.5.3	296.70
3.1.0 - 3.5.1	275.36

The card supports:

- SDI output with Matrox X.mio2
- SDI capture with NVIDIA Quadro SDI Output card
- G-SYNC II

18.1.2 NVIDIA Quadro 5000

Windows XP / Windows 7 (64bit)

Viz Artist/Engine Version	Driver
3.5.4	311.50
3.5.2 - 3.5.3	296.70
3.1.0 - 3.5.1	275.36

The card supports:

- SDI output with Matrox X.mio2
- SDI capture with NVIDIA Quadro SDI Output card
- G-SYNC II

18.1.3 NVIDIA Quadro 4000

Windows XP / Windows 7 (64bit)

Viz Artist/Engine Version	Driver
3.5.4	311.50
3.5.2 - 3.5.3	296.70
3.1.0 - 3.5.1	275.36

18.1.4 NVIDIA Quadro 2000

Windows XP / Windows 7 (64bit)

Viz Artist/Engine Version	Driver
3.5.4	311.50
3.5.2 - 3.5.3	296.70
3.1.0 - 3.5.1	275.36

18.1.5 NVIDIA Quadro FX 1400

Windows XP

Viz Artist/Engine Version	Driver
3.5.2	296.70
3.1.0 - 3.5.1	275.36
3.0	81.67

18.1.6 NVIDIA Quadro FX 1500

Windows XP

Viz Artist/Engine Version	Driver
3.5.2	296.70
3.1.0 - 3.5.1	275.36
3.0	162.62

18.1.7 NVIDIA Quadro FX 1700

Windows XP

Viz Artist/Engine Version	Driver
3.5.4	311.50
3.5.2 - 3.5.3	296.70
3.1.0 - 3.5.1	275.36
3.0	162.62

18.1.8 NVIDIA Quadro FX 1800

Windows XP

Viz Artist/Engine Version	Driver
3.5.4	311.50
3.5.2 - 3.5.3	296.70
3.1.0 - 3.5.1	275.36

18.1.9 NVIDIA Quadro FX 3400

Windows XP

Viz Artist/Engine Version	Driver
3.5.2	296.70
3.1.0 - 3.5.1	275.36
3.0	81.67

18.1.10 NVIDIA Quadro FX 3450

Windows XP

Viz Artist/Engine Version	Driver
3.5.2	296.70
3.1.0 - 3.5.1	275.36

18.1.11 NVIDIA Quadro FX 3500

Windows XP

Viz Artist/Engine Version	Driver
3.5.2	296.70
3.1.0 - 3.5.1	275.36
3.0	81.67

18.1.12 NVIDIA Quadro FX 3700

Windows XP

Viz Artist/Engine Version	Driver
3.5.4	311.50

Viz Artist/Engine Version	Driver
3.5.2 - 3.5.3	296.70
3.1.0 - 3.5.1	275.36
3.0	162.62

18.1.13 NVIDIA Quadro FX 3800

Windows XP

Viz Artist/Engine Version	Driver
3.5.4	311.50
3.5.2 - 3.5.3	296.70
3.1.0 - 3.5.1	275.36

18.1.14 NVIDIA Quadro FX 4400

Windows XP

Viz Artist/Engine Version	Driver
3.5.2	296.70
3.1.0 - 3.5.1	275.36

18.1.15 NVIDIA Quadro FX 4500

Windows XP

Viz Artist/Engine Version	Driver
3.5.2 - 3.5.3	296.70
3.1.0 - 3.5.1	275.36
3.0	83.62

The card supports:

- SDI output with Matrox X.mio2
- G-SYNC II

18.1.16 NVIDIA Quadro FX 4600

Windows XP

Viz Artist/Engine Version	Driver
3.5.4	311.50

Viz Artist/Engine Version	Driver
3.5.2 - 3.5.3	296.70
3.1.0 - 3.5.1	275.36
3.0	162.62

The card supports:

- SDI output with Matrox X.mio2

18.1.17 NVIDIA Quadro FX 4800

Windows XP

Viz Artist/Engine Version	Driver
3.5.4	311.50
3.5.2 - 3.5.3	296.70
3.1.0 - 3.5.1	275.36

The card supports:

- SDI output with Matrox X.mio2
- G-SYNC II

18.1.18 NVIDIA Quadro FX 5500

Windows XP

Viz Artist/Engine Version	Driver
3.5.2	296.70
3.1.0 - 3.5.1	275.36 (or 91.36 when used with Video Wall (SDI only))
3.0	162.62

The card supports:

- SDI output with Matrox X.mio2
- G-SYNC II

If you experience driver problems, set **use_old_nv sdk** to 1 in the Viz Config file.

18.1.19 NVIDIA Quadro FX 5600

Windows XP

Viz Artist/Engine Version	Driver
3.5.4	311.50

3.5.2 - 3.5.3	296.70
3.1.0 - 3.5.1	275.36
3.0	162.62

The card supports:

- SDI output with Matrox X.mio2

18.1.20 NVIDIA Quadro FX 5800

Windows XP

Viz Artist/Engine Version	Driver
3.5.4	311.50
3.5.2 - 3.5.3	296.70
3.1.0 - 3.5.1	275.36

The card supports:

- SDI output with Matrox X.mio2
- G-SYNC II

18.1.21 NVIDIA Quadro K600

Windows 7 (64bit) / Windows Server 2008 R2/SP1 (64bit)

Viz Artist/Engine Version	Driver
3.6.4	341.21

18.2 BlueFish444 SD Lite Pro Express

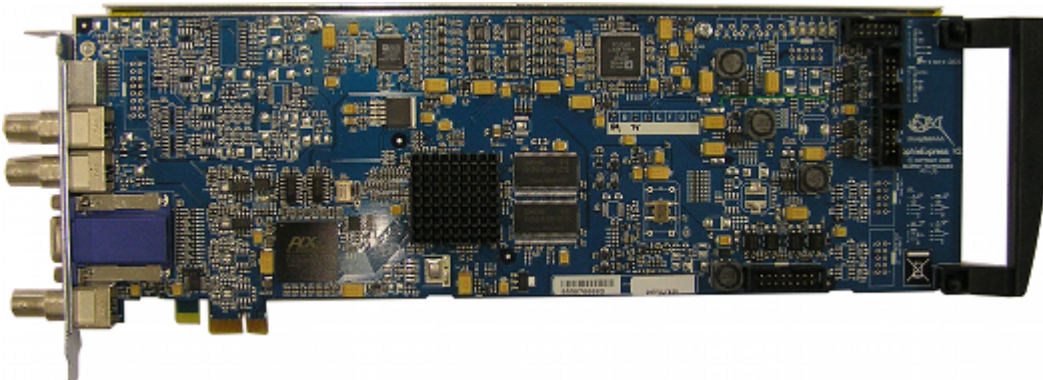

Viz supports the SD Lite Pro Express card, and the more recent BlueFish444 cards.

BlueFish444 SD Lite Pro Express provides Fill, Key and GenLock connectors, and is the successor of the BlueFish444 Iridium|SD and the Digital Voodoo DeepBlue LT, that are no longer officially supported.

The card was mostly used with Viz Trio NV which basically was a system with the ability to run a Viz Trio client with local preview and video output on a single machine; hence, there was no video input or video playback support as with the Matrox X.mio Series. The local preview was able to render a different scene than the one being output on video. The card was typically seen on HP xw4600 workstations.

This section contains information on the following topics:

- Connectors
- Driver Installation

18.2.1 Connectors

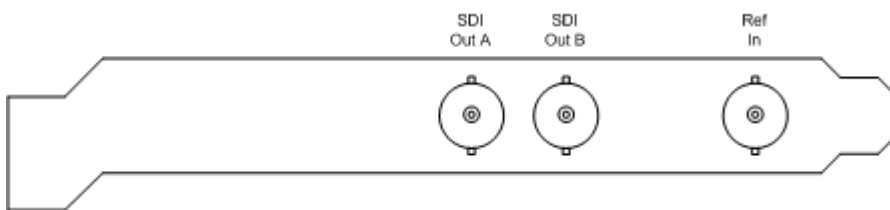

The BNC connectors from left to right are:

- **SDI Out A (Fill):** SDI 4:2:2/4:4:4/Video
- **SDI Out B (Key):** SDI 4:2:2/4:4:4/Video
- **Ref In:** Analog GenLock input

18.2.2 Driver Installation

Use the driver version available on Vizrt's FTP server to make sure of correct functionality and ring buffer support.

Viz Artist/Engine Version	Driver
3.6.3	Bluefish444 v5.10.2.18
3.6.1	Bluefish444 v5.10.2.4
3.5.1	Bluefish444 v5.10.1.11
3.5	Bluefish444 v5.9.0.78
3.2.7	Bluefish444 v5.9.0.25
3.2.2	Bluefish444 v5.7.6

.....
Note: Viz Engine 3.2.7 and 3.3.0 require the Bluefish444 v5.9.0.25 driver for all Digital Voodoo / Bluefish cards.

18.3 BlueFish444 Iridium|SD

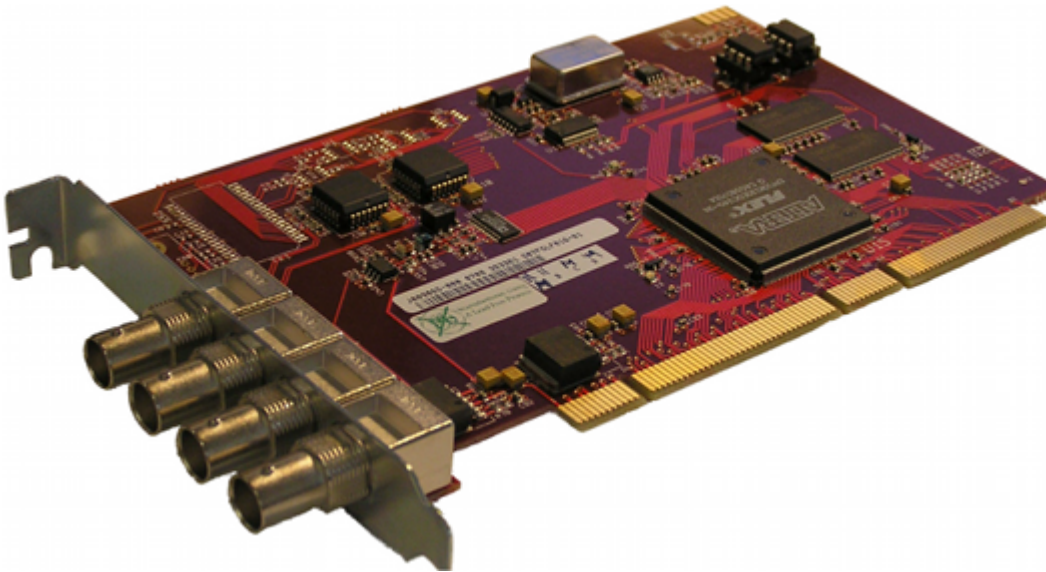

BlueFish444 Iridium|SD is the native successor of the Digital Voodoo DeepBlue LT and the predecessor of BlueFish444 SD Lite Pro Express, providing Fill, Key, GenLock and Composite Fill connectors. The Iridium|SD is fully compatible with older DeepBlue-LT installations.

The card was mostly used with Viz Trio NV which basically was a system with the ability to run a Viz Trio client with local preview and video output on a single machine; hence, there was no video input or video playback support as with the Matrox X.mio Series. The local preview was able to render a different scene than the one being output on video. The card was typically seen on HP xw4600.

.....
IMPORTANT! Supports for the Iridium|SD card ended with Viz Engine 3.5. For supported versions, see the most recent BlueFish444 cards.
.....

This section contains information on the following topics:

- Connectors
- Driver Installation

18.3.1 Connectors

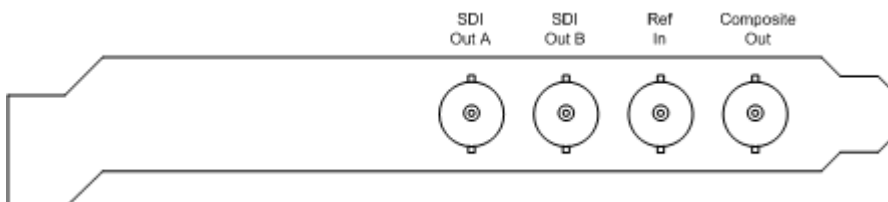

The BNC connectors from left to right are:

- **SDI Out A (Fill)** - SDI 4:2:2/4:4:4/Video

- **SDI Out B (Key)** - SDI 4:2:2/4:4:4/Video
- **Ref In** - Analog GenLock input
- **Composite Out** - Composite fill output

18.3.2 Driver Installation

The driver installation works the same way as for DeepBlue-LT cards. Use driver versions available on [Vizrt's FTP](#) server to make sure of correct functionality and ring buffer support.

Iridium|SD is fully compatible with existing DeepBlue-LT installations and can be used with any recent Viz version supporting the older DeepBlue-LT device.

.....
Caution: Only Bluefish444 v3.1 is guaranteed to support an adequate ringbuffer size. Any other driver will cut down or completely disable ringbuffer support.

Viz Artist/Engine Version	Driver
3.6.3	Bluefish444 v5.10.2.18
3.6.1	Bluefish444 v5.10.2.4
3.5.1	Bluefish444 v5.10.1.11
3.5	Bluefish444 v5.9.0.78
3.2.7	Bluefish444 v5.9.0.25
3.2.2	Bluefish444 v5.7.6
3.1.0-3532	Bluefish444 v3.1

.....
Note: Viz Engine 3.2.7 and 3.3.0 require the Bluefish444 v5.9.0.25 driver for all Digital Voodoo / Bluefish cards.

18.4 BlueFish444 Epoch 2K Horizon

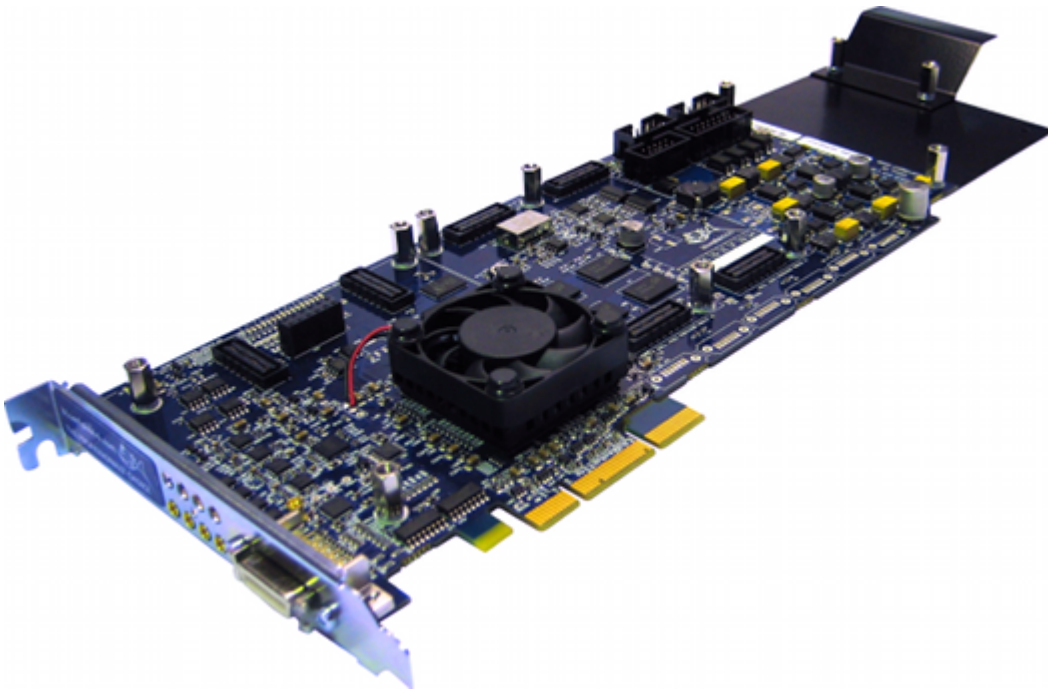

The BlueFish444 Epoch 2K Horizon board is intended for character generators such as Viz Trio, but can also be used as an alternative where only two inputs and outputs are required. The boards are typically installed on HP Z800 machines.

18.4.1 Configuration History

Use the driver version available on Vizrt’s FTP server to make sure of correct functionality and ring buffer support.

- 3.6.3, driver version Bluefish444 v5.10.2.18
- 3.6.1 - 3.6.2, driver version Bluefish444 v5.10.2.4
- 3.5.1 - 3.5.4, driver version Bluefish444 v5.10.1.11
- 3.5.0, driver version Bluefish444 v5.9.0.78

18.5 Digital Voodoo D1 Desktop

Digital Voodoo D1 Desktop was an older standard definition card that was rarely used, except sometimes with older machines such as IBM Z-Pro 6221, IBM 6223 or HP xw8200.

.....
IMPORTANT! Support for the D1 Desktop card ended with Viz Engine 3.5. For supported versions, see the most recent BlueFish444 cards.

18.5.1 Configuration History

Viz Artist/Engine Version	Driver
Up to Viz 3.5	VizrtVideo 2.3 (Revision - V1 and V2)

Caution: Older card revisions (V.1) are incompatible with recent systems like HP xw8200, xw8400,..... and IBM Z-Pro 6223. Symptoms are BSOD, machine freeze at Viz startup or corrupted live-video in Viz.

See Also

- BlueFish444 SD Lite Pro Express
- BlueFish444 Iridium|SD

18.6 Digital Voodoo DeepBlue LT

Digital Voodoo DeepBlue LT was used for standard definition Viz Trio No Video systems, typically on HP xw4200, xw4300 or xw4400 workstations.

IMPORTANT! Support for the DeepBlue LT card ended with Viz Engine 3.5. For supported versions, see the most recent BlueFish444 cards.

Caution: Only BlueFish444 v3.1 is guaranteed to support an adequate Ringbuffer-size. Any other driver will cut down or completely disable ring buffer support.

18.6.1 Configuration History

Viz Artist/Engine Version	Driver
3.6.3	Bluefish444 v5.10.2.18
3.6.1	Bluefish444 v5.10.2.4
3.5.1	Bluefish444 v5.10.1.11
3.5	Bluefish444 v5.9.0.78
3.2.7	Bluefish444 v5.9.0.25
3.2.2	Bluefish444 v5.7.6
3.1.0-3525	BlueFish444 v3.1

Note: Viz Engine 3.2.7 and 3.3.0 require the Bluefish444 v5.9.0.25 driver for all Digital Voodoo / Bluefish cards.

See Also

- BlueFish444 SD Lite Pro Express
- BlueFish444 Iridium|SD

18.7 Digital Voodoo Red Devil V3

Digital Voodoo Red Devil V3 alias IO/2020 was used for SD virtual sets and Viz Arena, typically on IBM Z-Pro 6221, IBM ZPro 6223, or HP xw8200 machines.

IMPORTANT! Support for the Red Devil card ended with Viz Engine 3.5. For supported versions,..... see the most recent BlueFish444 cards.

18.7.1 Configuration History

Viz Artist/Engine Version	Driver
Up to Viz 3.5	VizrtVideo 2.3 (Revision - V3)

See Also

- Digital Video Systems
- DVS Centaurus II

18.8 DVS Centaurus II

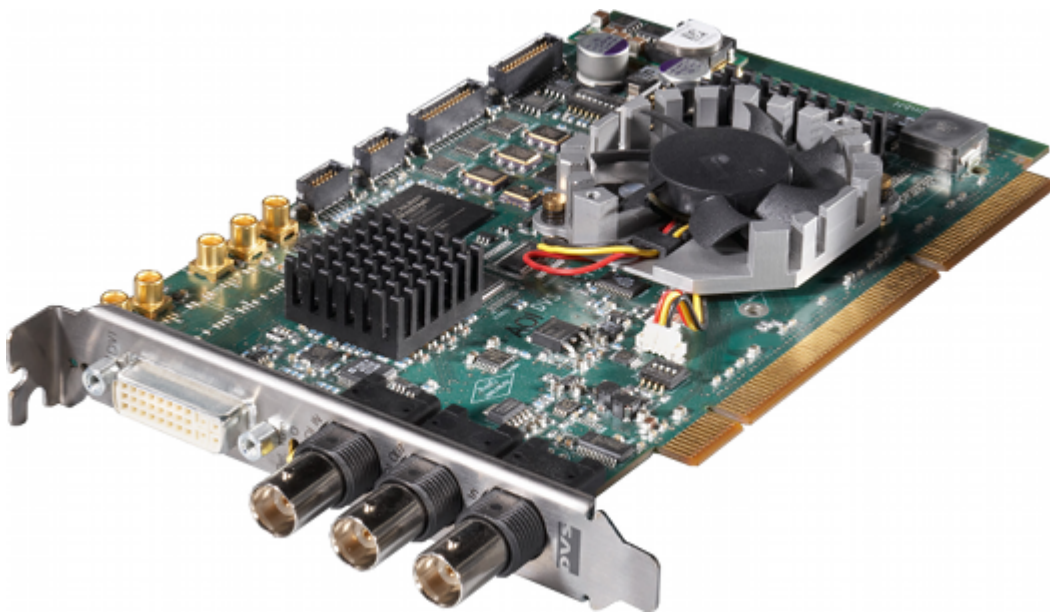

This section contains a description of the Digital Video Systems (DVS) Centaurus II video card.

The DVS was mainly sold with Viz Virtual Set and Viz Arena, and was Vizrt's successor of the Digital Voodoo Red Devil V3 card. The DVS is able to output both HD and SD unlike the Red Devil which could only output SD. The DVS was typically mounted in HP wx8400, HP xw8600 or HP Z800 machines.

This section contains information on the following topics:

- Connectors
- Supported Codecs
- Driver Installation
- Licensing

See Also

- Video, Audio, Server and Graphics Card Installation
- DVS support

18.8.1 Connectors

This section describes the main video card, the SDI/RS-422 extension card and how To Connect the DVS Centaurus II and SDI/RS-422 Extension Card.

This section contains information on the following topics:

- Main Card Connectors
- SDI and RS-422 Extension Card Connectors
- To Connect the DVS Centaurus II and SDI/RS-422 Extension Card

Main Card Connectors

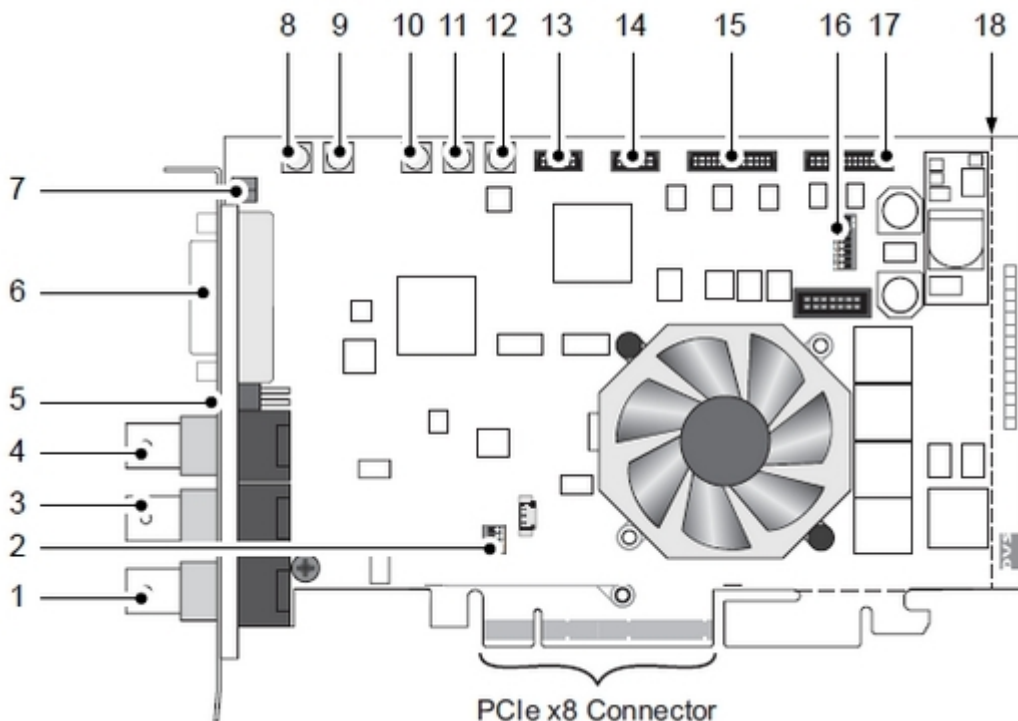

1. Ref. In: BNC connector for the reference input. May be Bi-/Tri-Level sync.
2. **DIP Switch for PCI:** PCI-X variant only: DIP switch to set up the PCI video card interface, that is its clock frequency; This switch is not available on the PCIe version of the card used by Vizrt.
3. (HD) SDI OUT A: BNC connector for a video output at port A (serial digital interface); usually used for an output of the first video channel in single-link (YUV) or the first stream of YUVA or RGBA in dual-link mode.
4. (HD) SDI IN A: BNC connector for a video input at port A (serial digital interface); usually used for an input of the first video channel in single-link (YUV) or the first stream of YUVA or RGBA in dual-link mode.
5. Ref. Term: Termination switch for the reference input; switches off the termination of the GenLock signal manually, for example if the Centaurus II card is not the last link in a GenLock connection chain.

6. DVI OUT: DVI connector for an output of analogue and digital video signals.
7. LEDs: Two status LEDs (Red/Green) indicating the presence of correct video and sync signals (see also Description of the LEDs on the video card).
8. SD SDI IN1: MCX connector for an input of digital SD video signals (serial digital interface)
9. (HD) SDI IN B: MCX connector for a video input at port B (serial digital interface); usually used for an input of the second video channel in single-link (YUV) or the second stream of YUVA or RGBA in dual-link mode.
10. (HD) SDI OUT B: MCX connector for a video output at port B (serial digital interface); usually used for an output of the second video channel in single-link (YUV) or the second stream of YUVA or RGBA in dual-link mode.
11. SD SDI OUT1: MCX connector for an output of digital SD video signals (serial digital interface)-
12. CVBS OUT: MCX connector for a composite video burst signal, either analogue output of SD video or used for synchronization purposes.
13. GPI: Flat cable connector for the general purpose interface.
14. RS-422: Flat cable connector for an in- and output of RS-422 signals
15. AUDIO 1-8/LTC: Flat cable connector for the digital audio channels 1 to 8 and LTC.
16. DIP Switch for Flash Controller: This switch controls the operation of the on-board Flash controller; it defines the version set of the map file that will be loaded at startup. The image above depicts the default setting of the DIP switch for the Flash controller; please observe the orientation of the switch on the card.



17. Audio 9-16: Flat cable connector for the digital audio channels 9 to 16.
18. Breaking line: The printed circuit board provides at its bottom (PCIe variant only) and right side extensions void of any electrical parts; these may serve to stabilize the installation of the card in a computer system; when not needed or interfering, you can break them off the circuit board at the breaking line(s); see also dotted lines in figure 1 on the previous page.

Description of the LEDs on the video card

LED	Function	Mode	Description
Green	Signals the status of the sync input	On	A correct sync signal is detected, that is:- Sync mode <i>internal</i> is set- Sync mode <i>external</i> is set and a correct signal is connected- Sync mode <i>analog</i> is set and an analog GenLock

LED	Function	Mode	Description
			signal is connected- Sync mode <i>digital</i> is set and a correct signal is connected
		Off	A wrong input signal is detected, i.e.: - Sync mode <i>external</i> is set and no SDI input signal. – Sync mode analog is set and no GenLock signal connected. – Sync mode digital is set and no SDI input signal.
Red	Signals the status of the video raster detection feature	Blinking slowly	No input signal is available
		Blinking fast	A wrong input signal is detected (for example DVS Centaurus II is set to NTSC video mode, but a PAL signal is connected to the active input)
		Off	A correct input signal is detected

SDI and RS-422 Extension Card Connectors

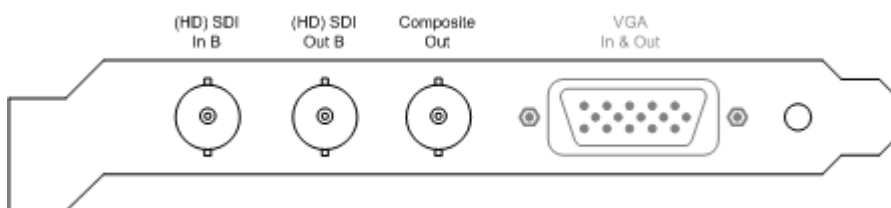

The SDI and RS-422 panel is included in the standard configuration of DVS Centaurus II. It provides the connectors for the second link of the dual-link connections. Additionally a CVBS output is installed on this panel that provides a composite video signal showing the fill signal generated by Viz Engine.

The RS-422 connector available on the panel is a DB-15 (HD) connector.

Note: This connector does not provide any additional functionality in regards to Viz Engine and should be ignored. The RS-422 port is not accessible to the operating system and can therefore not be used to transceive any kind of data by third-party applications.

-
- (HD) SDI In B: BNC connector for a video input at port B (serial digital interface); usually used for an input of the second video channel in single-link (YUV) or the second stream of YUVA or RGBA in dual-link mode.
 - (HD) SDI Out B: BNC connector for a video output at port B (serial digital interface); usually used for an output of the second video channel in single-link (YUV) or the second stream of YUVA or RGBA in dual-link mode.
 - CVBS Out: BNC connector for a composite video burst signal, either analogue output of SD video or used for synchronization purposes. Provides the fill output of Viz engine as an analogue signal.
 - RS-422 In & Out: DB-15 (HD) connector (female), serial RS-422 interface for master/slave control, a breakout cable to two DB-9 connectors is included in the delivery.
-

Note: This RS-422 connector is inactive and not accessible to the OS and can therefore not be used to transceive data.

To Connect the DVS Centaurus II and SDI/RS-422 Extension Card

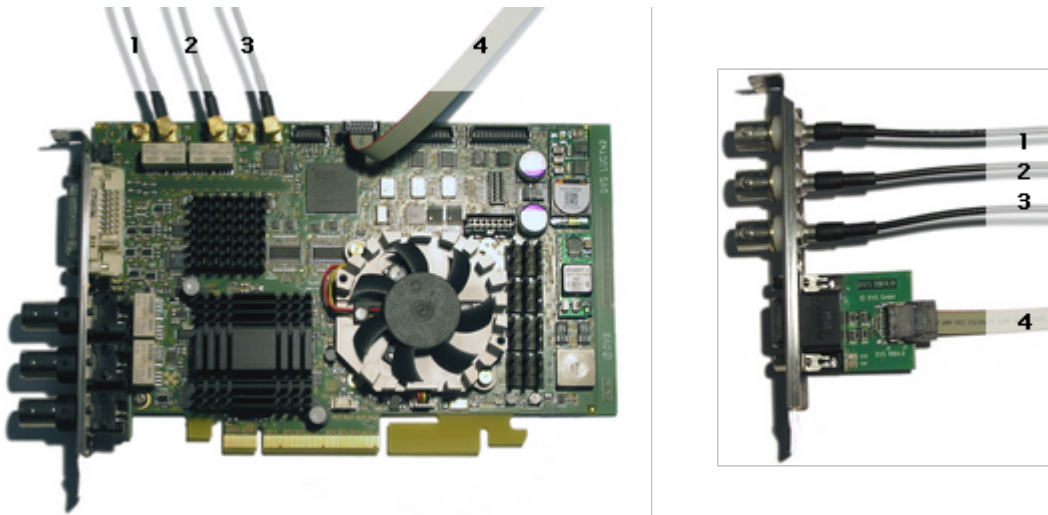

- Connect the separate SDI/RS-422 panel with the DVS Centaurus II main card according to the enumeration shown in the illustration above.

18.8.2 Supported Codecs

Currently, the DVS implementation only supports the Microsoft DirectShow Filtergraph framework to render video clips. Therefore it is possible to play for example MPEG files or streams from a server. For more information on how to use video clips in Viz, see the Viz Artist manual and in particular the Mo Viz plug-in.

Basically, it can play everything that can be played out by the Windows Media Player, so it depends on what codecs/DirectShow filters that are installed on the machine.

18.8.3 Driver Installation

The following driver versions are supported:

Viz Artist/Engine Version	Driver
3.5.4	SDK 4.3.5.10
3.5.2 - 3.5.3	SDK 4.2.9.8
3.3.0 - 3.5.1	SDK 4.0.1.15

For information on how to install or update the driver, see the DVS SDK 2.7 User Guide.

18.8.4 Licensing

A few additional steps are required before Viz Engine is able to use the DVS Centaurus II card after a first time installation. First it is necessary To Install a DVS Centaurus II License, and then To validate the DVS Centaurus II license.

.....
Note: Licensing should not be an issue if the DVS Centaurus II card came pre installed with the Viz Engine machine.

.....
Note: License information is stored in a memory region on the device itself and will not be lost if the card is mounted on another computer.

The license key required during the installation process is shipped together with the device and comes as a single sheet of machine-written paper looking something like the illustration below:

```

lic<xxxxxx>.txt
-----Date:
<xxxxxx>
  Licenser: <xxxxxx>
  Serialnumber: <xxxxxx>
  License does not expire
    rawkey 1 = <xxxxxx>
  rawkey 2 = <xxxxxx>
  rawkey 3 = <xxxxxx>
  To check licenses 'svram license show'
  For DDR type:
  sv license key1 <yyyyyy>
  For OEM type:
  svram license key1 <yyyyyy>
-----
# Product: Centaurus 2 PCIe
# License Key Options:
#
# Not-Expire
#
# Centaurus 2-Dual-Link
# Centaurus 2-Multi-Channel
-----

```

To Install a DVS Centaurus II License

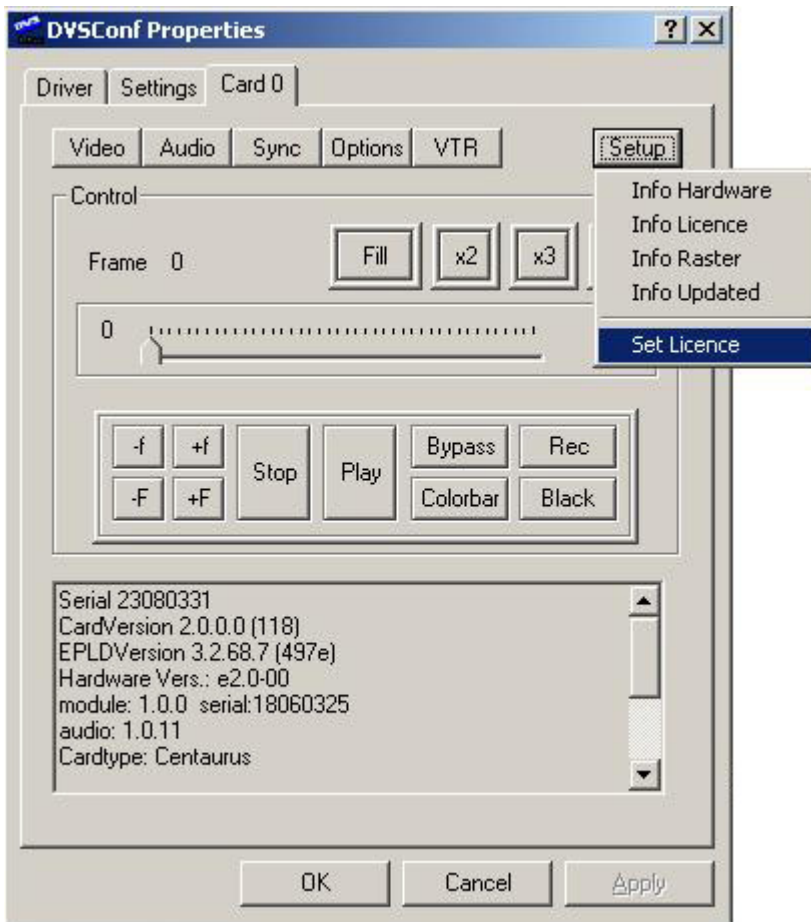

1. Locate and double-click the *dvsconfig.exe* file located in the driver folder downloaded from [Vizrt's FTP](#).
2. Select the *Card 0* tab.
 - When selecting the *Card 0* tab for the first time the system will inform that a license needs to be installed for the product.
3. Click *OK* to close the DVSCONF Warning dialog box.



4. Click the *Setup* button and select *Set Licence* from the appearing drop-down menu.
5. Enter the license key in field *Key 1* and click the *Set Key 1* button.

.....
Note: It has been reported that the key might be ignored and that validation fails although it was correctly entered. Re-enter the license string and try again.
.....

To validate the DVS Centaurus II license

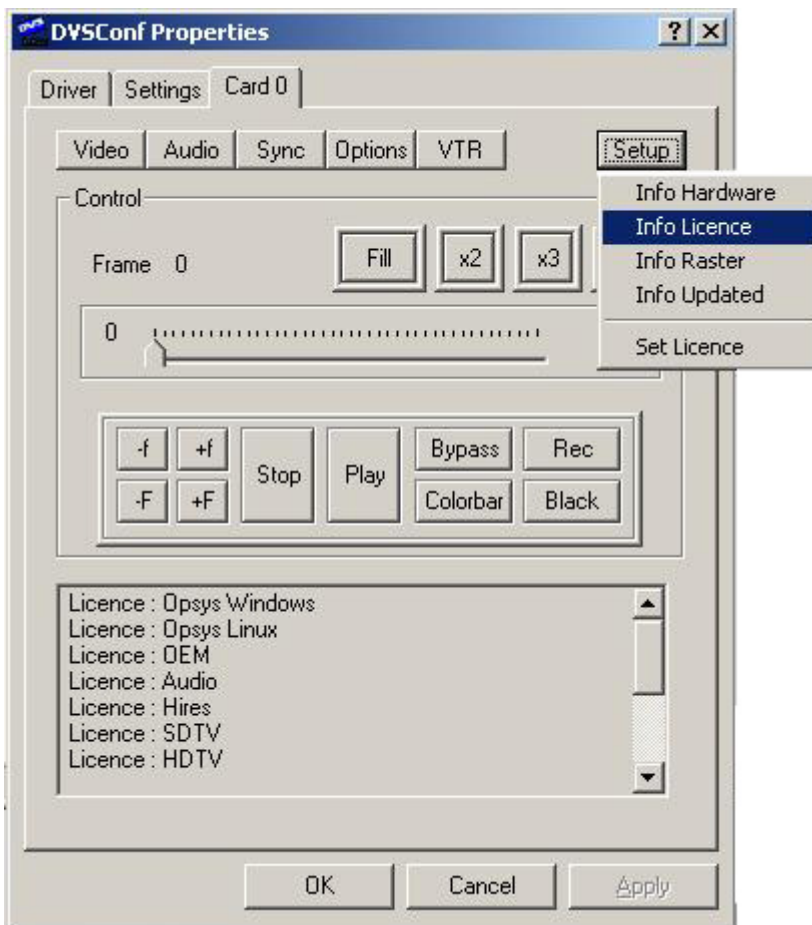

1. Locate and double-click the *dvsconfig.exe* file located in the driver folder downloaded from [Vizrt's FTP](#).
2. Select the *Card 0* tab.
3. Click the *Setup* button and select *Info License* from the appearing drop-down menu.
4. Check the following entries (bottom of the dialog box):
 - License : Ophys Windows
 - License : Ophys Linux
 - License : OEM
 - License : Multidevice
 - License : Audio
 - License : Hires
 - License : SDTV
 - License : HDTV
 - License : 12Bit
 - License : Processing
 - License : Mixer
 - License : ZoomAndPan
 - License : ColorCorrector
 - License : HDTVKeyChannel
 - License : HDTVDualLink

- License : SDTVKeyChannel
 - License : SDTVDualLink
5. Once all licenses are verified, click *OK* to close the program.

18.9 Pinnacle Targa 3200

Pinnacle Targa 3200 was Vizrt's standard card for SD Viz systems until 2007, and was typically used with IBM ZPro 6221, IBM Z-Pro 6223 and HP xw8200.

18.9.1 Configuration History

Driver	Revision
CODI v2.42	3213. Revision 3213 crashes the machine when used with CODI v2.41rc13.
CODI v2.41rc13	3212, 3214. Installation of CODI Compatibility Patch for revision 3214 is no more required.
CODI v2.42	3212, 3213, 3214. Installation of CODI Compatibility Patch is required.
CODI v2.2 RC4	3212, 3213

See Also

- Matrox X.mio Series

18.10 LPT Controller for a Viz License Dongle

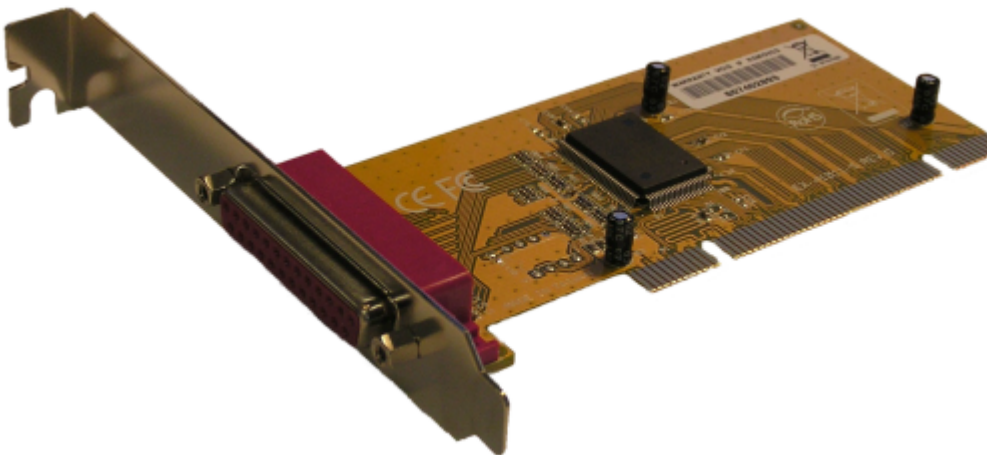

To provide recent render engines of type HP xw8600 with support for parallel dongles, an additional LPT controller card needs to be installed in the machine. For this purpose the topmost 32-bit PCI slot should be used.

18.10.1 To Install an LPT Controller Card

Adding the LPT controller card will enable Viz to read the license from a parallel port dongle.

1. Power down the system and prepare it for hardware installation as documented in the manufacturer's manual(s).
2. Install the controller in the xw8600's topmost standard PCI (32-bit) slot.
3. Turn on the machine.
4. After the operating system has started up, insert the LPT controller driver disk and install as denoted in the manufacturer's documentation.
5. After installation has finished, do not modify any device configurations, but instead simply use the default settings automatically applied at installation time.